



National Institute of  
**BUILDING SCIENCES™**

# NATURAL HAZARD MITIGATION SAVES

**2019 REPORT**

Innovative Solutions for the Built Environment

### NOTICE:

The results presented here and ongoing work to conduct this Interim Study have been generously funded by both public- and private-sector organizations interested in expanding the understanding of the benefits of hazard mitigation. While representatives from these organizations provided data and expertise to the project team, their input was merely informative, resulting in a truly independent study. Any opinions, findings, conclusions, or recommendations expressed in this publication do not necessarily reflect the views of the study funders. Additionally, NIBS nor any of its employees or subcontractors make any warranty, expressed or implied, nor assume any legal liability or responsibility for the accuracy, completeness, or usefulness of any information, product, or process included in this publication.

### SUGGESTED CITATION:

Multi-Hazard Mitigation Council (2019.). *Natural Hazard Mitigation Saves: 2019 Report*. Principal Investigator Porter, K.; Co-Principal Investigators Dash, N., Huyck, C., Santos, J., Scawthorn, C.; Investigators: Eguchi, M., Eguchi, R., Ghosh., S., Isteita, M., Mickey, K., Rashed, T., Reeder, A.; Schneider, P.; and Yuan, J., Directors, MMC. Investigator Intern: Cohen-Porter, A. National Institute of Building Sciences. Washington, DC. [www.nibs.org](http://www.nibs.org)

# Natural Hazard Mitigation Saves: 2019 REPORT

Compilation of latest findings on retrofit strategies with:  
*Natural Hazard Mitigation Saves: 2018 Interim report*  
*Natural Hazard Mitigation Saves: Utilities and Transportation Infrastructure*  
*Natural Hazard Mitigation Saves: 2017 Interim Report*

**PREPARED BY:**

National Institute of Building Sciences  
Multihazard Mitigation Council

**WITH SUPPORT OF**

Premier Plus Sponsor:



Premier Sponsors:



**LEAD SPONSOR:**



Sponsors:



Supporter:



# Foreword

When it comes to natural disasters like hurricanes, earthquakes, floods, and wildfire, 313 million people in the United States are affected.

More than ever, mitigating against these disasters is of paramount importance.

In 2005, the National Institute of Building Sciences released a study called *Natural Hazard Mitigation Saves: An Independent Study to Assess the Future Savings from Mitigation Activities*. Since then, we've updated it and added necessary pieces to this ever-changing climate puzzle.

Just in the last couple of years, the country endured some of its most devastating disasters. These include Category 5 hurricanes Michael, which struck the Florida panhandle in October 2018, and Maria, which devastated Dominica, U.S. Virgin Islands, and Puerto Rico in September 2017. Also in November 2018, the Camp Fire broke out in Northern California -- the deadliest and most destructive fire in California history.

Most recently, around the Fourth of July holiday this year, the Ridgecrest earthquake struck Southern California, just north of Los Angeles. This magnitude 7.1 earthquake was the most powerful to hit California in more than 20 years. It was felt by millions of people, and already more than 80,000 earthquakes have since been recorded in the Ridgecrest area.

Future disasters are inevitable, yet their growing frequency and magnitude of destruction substantially are exacerbated by the decisions Americans make in where and how they build. As cities and communities continue to grow, these events will affect more lives, businesses, and the nation's economy.

Fortunately, there are measures that individuals and communities can act upon to minimize destruction in hazard-prone areas.

Pre-disaster mitigation—preparing in advance for future disasters—assures that hazardous events are short-lived and more manageable. Mitigation saves lives, and preserves homes, businesses, government facilities, utilities, and transportation infrastructure. It reduces damage to belongings, helps economies spring back faster, and lowers recovery costs.

This report builds on where we started. It is our aim to help decision-makers build a mitigation strategy so they can protect lives, properties, and assets.

Our findings are intended to inform future code changes to make communities more resilient and help jurisdictions make decisions on the codes to adopt and enforce. We also aim to assist policymakers to develop effective federal programs that support pre-disaster mitigation and encourage more mitigation investments from the public and private sector.

## NATURAL HAZARD MITIGATION SAVES:

There were many involved in the production of this groundbreaking report. We offer a sincere thanks to the key stakeholder organizations identified at the beginning of this report – we could not have done this without you.

We also must express our heartfelt appreciation for the efforts of the project research, management, and oversight teams, Multihazard Mitigation Council, and the reviewers for their endless efforts and contributions.

And while we close the chapter on this iteration of the report, more work is needed to assess a broad suite of mitigation strategies. We hope you will consider supporting this project moving forward.

The National Institute of Building Sciences encourages the President, members of Congress and the state legislature, leaders of federal and state agencies, communities, building owners, and officials within the private finance, insurance, and real estate sectors to review this report and use the results to initiate a greater mitigation dialogue, increasing awareness and encouraging mitigation activities to help develop a more resilient nation.

Sincerely,

A handwritten signature in black ink, appearing to read 'Lakisha Woods', written in a cursive style.

Lakisha Ann Woods, CAE  
President & Chief Executive Officer

## Project Participants

The MMC Board wishes to acknowledge the efforts of the project participants, as follows.

### 2019 MMC BOARD OF DIRECTION

*Chair:* Bryan Koon, IEM, Tallahassee, FL

*Vice-Chair:* Keith Porter, SPA Risk LLC, Denver, CO

*Secretary:* Nancy McNabb, McNabb & Associates, Alexandria, VA

*At-Large:* Ryan Colker, International Code Council, Washington, DC

*At-Large:* Bradley Dean, Michael Baker International, Alexandria, VA

*Past Chair:* Kevin Mickey, Polis Center, Indianapolis, IN

NIBS Board Liaison: Carl Hedde, One Concern, Menlo Park, CA

*MMC Director:* Jiqui (JQ) Yuan, National Institute of Building Sciences, Washington, DC

### 2018 MMC BOARD OF DIRECTION

*Chair:* Bryan Koon, IEM, Tallahassee, FL

*Vice-Chair:* Keith Porter, SPA Risk LLC, Denver, CO

*Secretary:* Neil Blais, Blais & Associates, Little Elm, TX

*At-Large:* Nancy McNabb, McNabb & Associates, Alexandria, VA

*At-Large:* Sara Yerkes, International Code Council, Washington, DC

*Past Chair:* Kevin Mickey, Polis Center, Indianapolis, IN

NIBS Board Liaison: Carl Hedde, Munich Reinsurance America, Princeton, NJ

*MMC Director:* Philip Schneider (retired), National Institute of Building Sciences, Washington, DC

### 2017 MMC BOARD OF DIRECTION

*Chair:* Kevin Mickey, Polis Center, Indianapolis, IN

*Vice-Chair:* Bryan Koon, National Emergency Management Association, Lexington, KY

*Secretary:* Keith Porter, SPA Risk LLC, Denver, CO

*At-Large:* Nancy McNabb, McNabb & Associates, Alexandria, VA

*At-Large:* Sara Yerkes, International Code Council, Washington, DC

*Past Chair:* Neil Blais, Blais & Associates, Little Elm, TX

NIBS Board Liaison: Carl Hedde, Munich Reinsurance America, Princeton, NJ

*MMC Director:* Philip Schneider (retired), National Institute of Building Sciences, Washington, DC

### PROJECT TEAM

#### *Principal Investigators*

Keith Porter, SPA Risk LLC, Denver, CO, Principal Investigator

Charles Scawthorn, SPA Risk LLC, Berkeley, CA, Co-Principal Investigator

## NATURAL HAZARD MITIGATION SAVES:

Charles Huyck, Imagecat, Inc., Long Beach, CA, Co-Principal Investigator  
Nicole Dash, University of North Texas, Denton, TX, Co-Principal Investigator  
Joost Santos, George Washington University, Washington, DC, Co-Principal Investigator

### *Riverine Flooding*

Kevin Mickey, Polis Center, Indianapolis, IN, Investigator  
Tarek Rashed, Polis Center, Indianapolis, IN, Investigator  
Adam Reeder, CDM Smith, Raleigh, NC, Investigator

### *Coastal Flooding/Wind*

Charles Huyck, Imagecat, Inc., Long Beach, CA, Co-Principal Investigator  
Michael Eguchi, Imagecat, Inc., Long Beach, CA, Investigator  
Ron Eguchi, , Imagecat, Inc., Long Beach, CA, Investigator

### *Earthquake*

Keith Porter, SPA Risk LLC, Denver, CO, Principal Investigator  
Sannidhye Ghosh, University of Colorado Boulder, Investigator  
Zhenghui Hu, Imagecat, Inc., Long Beach, CA, Investigator  
Moad Isteita, University of Colorado Boulder, Investigator

### *Fire at the Wildland-Urban Interface*

Charles Scawthorn, SPA Risk LLC, Berkeley, CA, Co-Principal Investigator  
Althea Cohen-Porter, SPA Risk LLC, Denver CO, Investigator Intern

### *Economics*

Joost Santos, George Washington University, Washington, DC, Co-Principal Investigator

### *Social Issues*

Nicole Dash, University of North Texas, Denton, TX, Co-Principal Investigator

## PROJECT MANAGEMENT

### *National Institute of Building Sciences, Washington, DC*

Jiqui (JQ) Yuan, Executive Director of Multi-Hazard Mitigation and Building Seismic Safety Council

Philip Schneider (retired), Director, Multihazard Mitigation Council

### *Federal Emergency Management Agency (FEMA), Washington, DC*

Edward Laatsch, FEMA HQ

Jennifer Goldsmith-Grinspoon, FEMA HQ

### *Economic Development Administration, U.S. Department of Commerce*

Ryan Smith, EDA HQ

Bernadette Grafton, EDA HQ

## NATURAL HAZARD MITIGATION SAVES:

### *US Department of Housing and Urban Development*

Dana Bres, Sr Advisor for Disaster Response, Office of Policy Development and Research (PD&R)

Christopher J. Narducci, Social Science Analyst

### *International Code Council*

Dominic Simms, Chief Executive Officer

## OVERSIGHT COMMITTEE FOR FEDERAL GRANTS AND DESIGN TO EXCEED I-CODE REQUIREMENTS

### *Flood*

Neil Blais, Blais & Associates, Little Elm, TX, Oversight Committee Chair

Gavin Smith, Coastal Resilience Center of Excellence, Chapel Hill, NC

### *Wind*

Tim Reinhold, Insurance Institute for Business & Home Safety, Tampa, FL

Peter Vickery, Applied Research Associates, Raleigh, NC

### *Earthquake*

Brent Woodworth, Los Angeles Emergency Preparedness Foundation, Los Angeles, CA

Lucy Jones, Dr. Lucy Jones Center for Science and Society, Los Angeles, CA

Ron Lynn

### *Wildfire*

Jack Cohen, United States Forest Service, Missoula MT

Mark Finney, United States Forest Service, Missoula, MT

Robert Plonski, Savannah River National Laboratory, Aiken, SC

Kim Zagaris, California Office of Emergency Services, Mather, CA

### *Economics*

Phil Ganderton, University of New Mexico, Albuquerque, NM

Adam Rose, University of Southern California, Los Angeles, CA

### *Social Issues*

Lori Peek, Natural Hazards Center, Boulder, CO

Jennifer Helgeson, National Institute of Standards and Technology, Gaithersburg, MD

### *Building Codes*

Steven Winkel, The Preview Group, Inc., Berkeley, CA

Terese McAlister, National Institute of Standards and Technology, Gaithersburg, MD

Tim Ryan, City of Overland Park, KS

## OVERSIGHT COMMITTEE FOR ADOPTING I-CODE REQUIREMENTS



## NATURAL HAZARD MITIGATION SAVES:

### *Flood*

Shane Parson, AECOM, Roanoke, VA

### *Wind*

Anne Cope, Insurance Institute for Business and Home Safety, Tampa, FL

### *Earthquake*

Ron Lynn, Henderson, NV

### *Economics*

Phil Ganderton, University of New Mexico, Albuquerque, NM

### *Social Issues*

Lori Peek, Natural Hazards Center, Boulder, CO

## OVERSIGHT COMMITTEE FOR UTILITY AND TRANSPORTATION INFRASTRUCTURE

### *Water Supply*

Craig Davis, Los Angeles Department of Water and Power, Los Angeles, CA

Smiti Nepal, Environmental Protection Agency, Washington, DC

### *Electricity*

Wally Mealiea, Edison Electric Institute, Washington, DC

Sandor Williams, Exelon, Oakbrook Terrace IL

## OVERSIGHT COMMITTEE FOR PRIVATE-SECTOR BUILDING RETROFIT

### *Flood*

Alan Lulloff, American Society of Floodplain Managers, Madison, WI

Randall Behm, US Army Corps of Engineers, Omaha, NE

### *Wind*

Anne Cope, Insurance Institute for Business and Home Safety, Tampa, FL

### *Earthquake*

Lucy Jones, Dr. Lucy Jones Center for Science and Society, Los Angeles, CA

### *Economics*

Adam Rose, University of Southern California, Los Angeles, CA

### *Social Issues*

Lori Peek, Natural Hazards Center, Boulder, CO

### FEMA REVIEWERS FOR FEDERAL GRANTS AND DESIGN TO EXCEED I-CODE REQUIREMENTS

#### *Flood*

John Ingargiola, FEMA HQ  
Jonathan Westcott, FEMA HQ  
Adam Reeder, CDM Smith  
Stuart Adams, Stantec, Laurel, MD

#### *Wind*

Drew Herseth, FEMA HQ  
Thomas Smith, TlSmith Consulting Inc  
Manny Perotin, CDM Smith

#### *Wildfire*

Patricia Blankenship, FEMA, United States Fire Administration  
Phyllis Krietz, FEMA, United States Fire Administration

#### *Earthquake*

Michael Mahoney, FEMA HQ  
Mai Tong, FEMA HQ  
Ronald Hamburger, Simpson Gumpertz & Heger  
Robert Hanson, University of Michigan

#### *Economics*

Jody Springer, FEMA HQ  
Samuel Capasso, FEMA HQ  
James Hamilton, FEMA HQ  
James Ruger, FEMA HQ

#### *General*

Nick Shufro, FEMA HQ  
Eric Letvin, FEMA HQ  
Edward Laatsch, FEMA HQ  
Jennifer Goldsmith-Grinspoon, FEMA HQ

### INTERNATIONAL CODE COUNCIL REVIEWERS FOR CODE ADOPTION

Susan Dowty, ICC  
Gabriel Maser, ICC  
Michael Pfeiffer, ICC  
Don Scott, PCS Structural Solutions  
Dominic Sims, ICC  
Sara Yerkes, ICC

### STAKEHOLDERS

Sheri Aguirre, California Earthquake Authority, Mather, CA  
Marissa Aho, City of Los Angeles, Los Angeles, CA  
Illya Azaroff, American Institute of Architects, Washington, DC  
Debra Ballen, Insurance Institute for Business & Home Safety, Tampa, FL  
Christopher Biolsi, Economic Policy, Office of Management and Budget, Washington, DC  
Sabrina Bornstein, City of Los Angeles, Los Angeles, CA  
Dana Bres, U.S. Department of Housing and Urban Development, Washington, DC  
Lindsay Brugger, American Institute of Architects, Washington, DC  
Anna Bruno, Fannie Mae, Washington, DC  
Dennis Burke, Reinsurance Association of America, Washington, DC  
Lauren Burnhill, One Planet Ventures, Chevy Chase, MD  
Leslie Chapman-Henderson, Federal Alliance for Safe Homes, Tallahassee, FL  
Noreen Clancy, Rand Corporation, Arlington, VA  
Shannon Cunniff, Environmental Defense Fund, Washington, DC  
Lisa Dickson, ARUP America, Washington, DC  
Gary Ehrlich, National Association of Home Builders, Washington, DC  
Mary Fitzpatrick, Information and Regulatory Affairs, Office of Management and Budget, Washington, DC  
Andrea Goel, Resource Management Office, Office of Management and Budget, Washington, DC  
Bernadette Grafton, Economic Development Administration, U.S. Department of Commerce, Washington, DC  
Ashley Gunn, Mortgage Bankers Association, Washington, DC  
Britten Harter, PricewaterhouseCoopers Advisory, Boston, MA  
Donald Hornstein, University of North Carolina, Chapel Hill, NC  
Carrie Johnson, Wallace Engineering Structural Consultants, Inc., Tulsa, OK  
Lynsey Johnson, U.S. Department of Housing and Urban Development, Washington, DC  
Shannon Joyce, Information and Regulatory Affairs, Office of Management and Budget, Washington, DC  
Jay Koh, Lightsmith Group, New York, NY  
Bryan Koon, National Emergency Management Association, Lexington, KY  
Sandra Knight, University of Maryland Center for Disaster Resilience, College Park, MD  
Ryan Littlewood, Stantec, Laurel, MD  
Sara Lopez, Resource Management Office, Office of Management and Budget, Washington, DC  
Alan Lulloff, American Society of Floodplain Managers, Madison, WI  
Steven McCabe, National Institute of Standards and Technology, Gaithersburg, MD  
Kathy McCleod, The Nature Conservancy, Arlington, VA  
David G. McKey, Coldwell Banker One, Prairieville, LA  
Rachel Minnerly, American Institute of Architects, Washington, DC  
Kevin Moore, Structural Engineers Association of California, Sacramento, CA  
Christopher Ochoa, International Code Council, Washington, DC

## NATURAL HAZARD MITIGATION SAVES:

Brenda O’Conner, Insurance Institute for Business & Home Safety, Tampa, FL  
Brian O’Conner, National Fire Protection Association, Washington, DC  
Steven Orłowski, Building Owners and Managers Association, Washington, DC  
Austin Perez, National Association of Realtors, Washington, DC  
Natalie Peyronnin, Environmental Defense Fund, Washington, DC  
Evan Reis, U.S. Resiliency Council, San Francisco, CA  
Audrey Rierson, Federal Alliance for Safe Homes, Tallahassee, FL  
Julie Rochman, Insurance Institute for Business & Home Safety, Tampa, FL  
Dominic Sims, International Code Council, Washington, DC  
Ryan Smith, Economic Development Administration, U.S. Department of Commerce, Washington, DC  
Aaron Strong, Rand Corporation, Arlington, VA  
Jessica Sun, Resource Management Office, Office of Management and Budget, Washington, DC  
Edward Thomas, Natural Hazards Mitigation Association, Metairie, LA  
Dale Thomure, ISO – Verisk Analytics, Jersey City, NJ  
Shana Udvardy, Union of Concerned Scientists, Washington, DC  
Billy Ward, Champion Homes, Auburn Hills, MI  
Sara Yerkes, International Code Council, Washington, DC

### EDITORS/PUBLICATION SPECIALISTS

Christine Cube, National Institute of Building Sciences  
Kristen Petersen, National Institute of Building Sciences  
Gretchen Hesbacher, former employee of National Institute of Building Sciences  
Ryan Colker, former employee of National Institute of Building Sciences

In memory of our friends and colleagues Drs. Craig Taylor and Linda Bourque, contributors to the original Natural Hazard Mitigation Saves report.

# Table of Contents

Foreword .....	i
Project Participants .....	iii
Summary of Findings .....	1
BCRs in Greater Depth .....	4
Mitigation Benefits at the State and Local Level .....	10
Building on the 2005 Mitigation Saves Study .....	14
Mitigation Measures Studied .....	14
Multiple Stakeholders Benefit from Adopting or Exceeding I-Code Requirements .....	17
Additional Mitigation Measures .....	19
Benefits Accrue Across a Spectrum of Design Options .....	19
Utilizing the Best Available Science .....	22
Incentivization Can Facilitate Ideal Levels of Investment .....	22
Results Inform Mitigation Decision-Making .....	23
Expert Contributions to the Interim Study .....	23
Federal- and Private-Sector Support for the Interim Study .....	23
Technical Documentation .....	25
1. Introduction .....	26
1.1. Background .....	26
1.2. Objectives .....	29
1.3. Organization of Interim Report .....	36
2. Findings .....	37
2.1. Summary of Results .....	37
2.2. Results from Designing to Exceed Commonly Adopted 2015 I-Code Requirements .....	40
2.2.1. Designing to Exceed 2015 I-Code Requirements for Riverine Flood .....	40
2.2.2. Designing to Exceed 2015 I-Code Requirements for Hurricane Surge .....	44
2.2.3. Designing to Exceed 2015 I-Code Requirements for Hurricane Wind .....	49
2.2.4. Designing to Exceed 2015 I-Code Requirements for Earthquake .....	57
2.2.5. Complying with 2015 IWUIC .....	63
2.2.6. Incentivization .....	65
2.3. Results from Adopting 2018 I-Code Requirements .....	67
2.3.1. Quantifying the Contributions of Code Adoptions .....	67
2.3.2. I-Codes Protect New Buildings from Different Perils in Different Places .....	67

2.3.3.	Adopting 2018 I-Code for Riverine Flood .....	69
2.3.4.	Adopting 2018 I-Code for Hurricane Wind .....	71
2.3.5.	Adopting 2018 I-Code for Earthquake .....	73
2.4.	Results from Enhancing Utilities and Transportation Lifelines .....	75
2.5.	Results from Federal Grants.....	77
2.5.1.	Grants for Flood Mitigation.....	77
2.5.2.	Grants for Wind Mitigation.....	78
2.5.3.	Grants for Earthquake Mitigation .....	80
2.5.4.	Grants to Mitigate Fire at the WUI .....	82
2.6.	BCRs for Retrofit of Private-Sector Buildings .....	83
2.6.1.	BCRs for Flood Retrofit of Single-Family Dwellings .....	83
2.6.2.	BCRs for Hurricane Wind Retrofit of Private-Sector Buildings .....	96
2.6.3.	BCRs for Seismic Retrofit of Private-Sector Buildings .....	101
2.6.4.	BCRs for WUI Fire Retrofit of Private-Sector Buildings.....	112
2.7.	Aggregate Benefits and Costs.....	115
2.8.	Recap of Interim Study Findings.....	118
2.9.	Natural Hazard Mitigation Saves in Every State .....	119
2.10.	All Stakeholders Benefit from Adopting or Exceeding I-Code Requirements.....	119
2.11.	Synergies Across Mitigation Strategies .....	121
2.12.	Applying Alternative Discount Rates.....	122
2.12.1.	OMB Discount Rates.....	122
2.12.2.	Calculating BCRs with a 3% Discount Rate .....	123
2.12.3.	Calculating BCRs with a 7% Discount Rate .....	125
2.13.	Jobs Created by Adopting or Exceeding Commonly Adopted I-Code Requirements .....	126
2.14.	Avoided Deaths, Injuries, and Cases of PTSD.....	127
2.15.	Savings to the Federal Treasury.....	128
2.16.	Other Sensitivity Tests.....	131
2.16.1.	Designing to Exceed 2015 I-Code Requirements for Coastal Flooding .....	131
2.16.2.	Designing to Exceed 2015 I-Code Requirements for Hurricane Wind.....	132
2.16.3.	Designing to Exceed 2015 I-Code Requirements for Earthquake .....	133
2.16.4.	Designing to Comply with 2015 IWUIC .....	135
2.16.5.	Federal Grants .....	136
<b>3.</b>	<b>Review of Mitigation Guidance and Quantification of Benefits.....</b>	<b>137</b>
3.1.	Building on Prior Work .....	137
3.2.	Relevant Building Codes and Standards .....	137
3.3.	How Past Design and Construction Differs from Current I-Codes .....	138
3.3.1.	How Past Wind Design and Construction Differs from Current I-Codes .....	138
3.3.2.	How Past and Some Current Flood Design and Construction Differs from Current I-Codes.....	141

3.3.3. How Past Earthquake Design and Construction Differs from Current I-Codes .....	142
3.4. Options to Exceed Commonly Adopted Code Requirements .....	143
3.4.1. Options to Exceed Minimum Wind Design Requirements .....	143
3.4.2. Options to Exceed Minimum Flood Design Requirements .....	145
3.4.3. Options to Exceed Minimum Earthquake Design Requirements .....	148
3.4.4. Complying with the IWUC .....	150
3.5. Options to Adopt or Better Enforce Minimum Design Requirements .....	151
3.6. Estimating Benefits and Costs of Adopting Code Requirements .....	154
3.7. Estimating Benefits and Costs of Exceeding Code Requirements .....	155
3.8. Efforts to Estimate Benefits and Costs of Private-Sector Retrofit .....	155
3.8.1. Literature on Flood Retrofit of Private-Sector Buildings .....	155
3.8.2. Literature on Hurricane Wind Retrofit of Private-Sector Buildings .....	158
3.8.3. Literature on Seismic Retrofit of Private-Sector Buildings .....	163
3.8.4. Literature on WUI Fire Retrofit of Private-Sector Buildings .....	174
3.9. Efforts to Estimate Benefits and Costs of Federal Grants .....	180
3.10. Methods to Quantify Business Interruption Losses .....	181
3.11. Methods to Quantify Social Impacts .....	182
3.12. Methods to Quantify Other Intangibles .....	183
3.13. Land Use Planning to Reduce Flood Hazard .....	183
3.14. Flood Risk Modeling .....	185
3.15. Estimating Future Growth .....	189
3.16. Alternatives to BCA for Natural Hazard Mitigation .....	190
<b>4. Methodology Employed in This Study .....</b>	<b>191</b>
4.1. Engineering Approach to BCA .....	191
4.2. BCA for Mitigation Estimates Long-Term Averages .....	192
4.3. Calculating Aggregate Benefit-Cost Ratio .....	193
4.4. Selection of Designs to Reflect Below-Code Practice .....	197
4.4.1. Below-Code Designs for Wind .....	197
4.4.2. Below-Code Designs for Flood .....	197
4.4.3. Below-Code Designs for Earthquake .....	198
4.5. Selection of Designs to Exceed 2015 I-Code Requirements .....	199
4.6. Selection and Analysis of Private-Sector Retrofit Measures .....	200
4.6.1. Selection and Analysis of Flood Retrofit of Single-Family Dwellings .....	200
4.6.2. Selection and Analysis of Hurricane Wind Retrofit of Private-Sector Buildings .....	208
4.6.3. Selection and Analysis of Seismic Retrofit of Private-Sector Buildings .....	214
4.6.4. Selection and Analysis of WUI Fire Retrofit of Private-Sector Buildings .....	230
4.7. Identifying the IEMax Level of Additional Mitigation .....	230
4.8. BCA of Federal Mitigation Grants .....	231
4.9. Grant Sampling Strategy .....	231



4.10. Notes on Riverine Flood Methodology.....	233
4.11. Estimating Exposure.....	235
4.11.1. Present Day Exposure .....	235
4.11.2. Creating a Proxy Portfolio for Designing to Exceed I-Code Requirements for Riverine Flood.....	240
4.11.3. Estimating Building Exposure for Riverine Flooding.....	245
4.11.4. Estimating Building Exposure for Coastal Inundation.....	246
4.11.5. Number of People and Households Based on Number of Buildings.....	247
4.12. ESTIMATING HAZARD.....	247
4.12.1. Estimating Riverine Flood Hazard .....	248
4.12.2. Estimating Storm Surge Hazard.....	249
4.12.3. Estimating Hurricane Wind Hazard .....	253
4.12.4. Estimating Tornado Wind Hazard.....	256
4.12.5. Estimating Seismic Hazard .....	256
4.12.6. Estimating Fire Hazard .....	266
4.13. Estimating Vulnerability .....	268
4.13.1. Estimating Vulnerability in General .....	268
4.13.2. Estimating Riverine Flood Vulnerability .....	269
4.13.3. Estimating Coastal Flooding Vulnerability .....	269
4.13.4. Estimating Hurricane Wind Vulnerability .....	270
4.13.5. Estimating Seismic Vulnerability .....	278
4.13.6. Estimating Fire Vulnerability.....	283
4.14. Estimating Property Repair Cost and Repair Duration.....	284
4.15. Residential Displacement Cost (Additional Living Expenses).....	284
4.16. Estimating Business Interruption Loss.....	285
4.16.1. Model Parameters .....	285
4.16.2. Sector Inoperability.....	286
4.16.3. Interdependency Matrix .....	286
4.16.4. Demand Perturbation .....	287
4.16.5. Economic Resilience.....	287
4.16.6. Economic Loss.....	288
4.16.7. Relating Hazus Results with IO Assessment of Indirect Business Interruption.....	289
4.16.8. Additional Considerations in Estimating Business Interruption Losses .....	296
4.17. Estimating Total (Direct and Indirect) Business Interruption Loss.....	297
4.18. Insurance Benefits.....	299
4.19. Deaths, Nonfatal Injuries, and Post-Traumatic Stress Disorder .....	301
4.19.1. Deaths and Nonfatal Injuries .....	301
4.19.2. Post-Traumatic Stress Disorder (PTSD) .....	302
4.19.3. Discounting Human Life, Nonfatal Injuries, and PTSD .....	303
4.20. Other Intangibles .....	304

4.21. Estimating Expected Annualized Losses.....	305
4.22. Estimating and Aggregating Benefits and Costs to the National Level .....	306
4.22.1. Aggregating Above-Code Design Results by Peril to the National Level .....	306
4.22.2. Aggregating Federal Grant Results by Peril to the National Level .....	308
4.22.3. Aggregating Results Across Perils to a Nationwide Level.....	310
4.23. Allocating Net Benefits to Stakeholder Groups .....	311
4.24. Job Creation.....	315
<b>5. Project Data, Sampling, and Other Analytical Details .....</b>	<b>317</b>
5.1. Federal Mitigation Program Data.....	317
5.2. Adopting I-Code Requirements for Riverine Flood .....	324
5.2.1. Building Inventory for Below-Code Design for Riverine Flood .....	324
5.2.2. Cost to Comply with 2018 I-Codes for Riverine Flood .....	325
5.2.3. Benefits of Complying with 2018 I-Codes for Riverine Flood .....	326
5.3. Designing to Exceed I-Code Requirements for Riverine Flood.....	332
5.3.1. Building Inventory for Above-Code Design for Riverine Flood.....	332
5.3.2. Cost of Designing to Exceed I-Code Requirements for Riverine Flood .....	334
5.3.3. Life-Safety and Additional Living Expense Benefits of Designing to Exceed I-Code Requirements for Riverine Flood.....	335
5.4. Grants for Riverine Flood Mitigation .....	335
5.4.1. Building Inventory for Flood Mitigation Grants .....	335
5.4.2. Riverine Flood Grant Sample.....	341
5.4.3. BCA of Riverine Flood Grants.....	342
5.5. Analysis of Flood Retrofit Measures .....	345
5.5.1. Analytical Details of Flood Retrofits for Single-Family Dwellings.....	345
5.5.2. Analytical Details of Acquisition of Single-Family Dwellings .....	348
5.5.3. Analytical Details of Retrofit Elevation of Single-Family Dwellings .....	354
5.5.4. Analytical Details of Wet Floodproofing Basements of Single-Family Dwellings.....	357
5.5.5. Analytical Details of Utility Retrofits of Single-Family Dwellings.....	358
5.5.6. Analytical Details of Summarizing the Overall Single-Family Dwellings.....	360
5.6. Designing to Exceed I-Code Requirements for Hurricane Surge.....	362
5.7. Grants for Wind Mitigation .....	363
5.8. Adopting I-Code Requirements for Hurricane .....	363
5.8.1. Building Inventory for Below-Code Design for Wind .....	363
5.8.2. Cost of Complying with 2018 I-Codes for Wind .....	364
5.9. Private-Sector Hurricane Wind Retrofit Measures.....	364
5.9.1. Analytical Details of Hurricane Wind Retrofit Regarding IBHS FORTIFIED Home .....	364
5.9.2. Analytical Details of Hurricane Wind Retrofit for Manufactured Housing .....	365
5.10. Adopting I-Code Requirements for Earthquake .....	367
5.10.1. Building Inventory for Below-Code Design for Earthquake.....	367

5.10.2.	Cost of Complying with 2018 I-Codes for Earthquake.....	368
5.10.3.	Benefit of Complying with 2018 I-Codes for Earthquake.....	368
5.11.	Designing to Exceed I-Code Requirements for Earthquake.....	369
5.11.1.	Cost to Build New Buildings to Exceed I-Code Requirements for Earthquake.....	369
5.11.2.	Vulnerability of Buildings that Exceed I-Code Requirements for Earthquake.....	371
5.12.	Grants for Earthquake Mitigation.....	373
5.13.	Private-Sector Seismic Retrofit Measures.....	377
5.13.1.	Analytical Details of Seismic Retrofit for Soft-Story Wood-Frame Multifamily Dwellings.....	377
5.13.2.	Analytical Details of Seismic Retrofit for Manufactured Housing.....	378
5.13.3.	Analytical Details of Securing Residential Furnishings, Fixtures, Equipment, and Contents.....	379
5.14.	Grants for Fire at the WUI.....	380
5.15.	Private-Sector WUI Retrofit.....	382
<b>6.</b>	<b>Utilities and Transportation Lifelines.....</b>	<b>384</b>
6.1.	Introduction.....	384
6.1.1.	Objectives.....	384
6.2.	Benefit-Cost Analyses of 12 EDA Grants.....	385
6.2.1.	EDA-Funded Flood Mitigation for Roads and Railroads.....	385
6.2.2.	EDA-Funded Flood Mitigation for Water and Wastewater Infrastructure.....	396
6.2.3.	Flood Mitigation for Electric and Telecommunications Substation in Reedsburg, Wisconsin.....	408
6.2.4.	Wind Mitigation for Electric and Telecommunications.....	410
6.3.	Benefit-Cost Analysis of Resilient Water Supply Grid.....	422
6.3.1.	Introduction.....	422
6.3.2.	Analytical Method.....	424
6.3.3.	Vulnerability Under As-is Conditions.....	452
6.3.4.	Vulnerability with Resilient Grid.....	460
6.3.5.	Results.....	461
6.3.6.	Summary and Conclusions.....	463
6.4.	Benefit-Cost Analysis of a Resilient Electric Grid.....	466
6.4.1.	Purpose and Focus.....	466
6.4.2.	Electric Power Grid and Substations Vulnerability.....	471
6.4.3.	Impacts of Loss of Electric Power.....	475
6.4.4.	Benefit-Cost Analysis.....	478
6.5.	Benefit-Cost Analysis of Highway Bridge Mitigation for Earthquake.....	480
6.5.1.	Background.....	480
6.5.2.	REDARS Technical Specifications.....	481
6.5.3.	Benefit-Cost Analyses.....	482

6.5.4. BCR Results.....	483
<b>7. References.....</b>	<b>484</b>
<b>Appendix A. Glossary and List of Acronyms.....</b>	<b>521</b>
A.1. Glossary.....	521
A.2. List of Acronyms.....	523
<b>Appendix B. Databases.....</b>	<b>527</b>
B.1. Building-Related Grants.....	527
B.2. Data.gov Database of HMGP grants.....	528
B.3. PA Data Availability.....	528
B.4. EDA.....	530
<b>Appendix C. City of Moore Wind Code Enhancements.....</b>	<b>531</b>
<b>Appendix D. Which PA Grant Years to Include.....</b>	<b>532</b>
<b>Appendix E. Innovations Since the 2005 Mitigation Saves Study.....</b>	<b>533</b>
<b>Appendix F. Sea Level Rise.....</b>	<b>535</b>
<b>Appendix G. Quality Assurance Procedures.....</b>	<b>542</b>
G.1. Project Quality Assurance Plan.....	542
G.2. QA Procedures for Seismic Hazard and Seismic Vulnerability.....	544
<b>Appendix H. Discount Rate.....</b>	<b>546</b>
H.1. Options for Selecting the Discount Rate.....	546
H.2. Real Cost of Borrowing.....	547
H.3. Discount Rates According to OMB Circular A-4.....	548
<b>Appendix I. Actual Economic Life of North American Buildings.....</b>	<b>549</b>
<b>Appendix J. Cost of Greater Elevation.....</b>	<b>551</b>
<b>Appendix K. Details of Seismic Vulnerability.....</b>	<b>552</b>
K.1. Preface.....	552
K.2. Calculating the Capacity Curve.....	552
K.3. Calculate Input Motion for Each Point on the Capacity Curve.....	559
K.4. Calculate Damage for Each Point on the Capacity Curve.....	563
K.5. Calculate Building Repair Cost as a Fraction of Building Replacement Cost.....	566
K.6. Calculate Content Repair Cost as a Fraction of Content Replacement Cost.....	570
K.7. Calculate Injured Occupants as a Fraction of All Indoor Occupants.....	570

K.8. Calculate Loss of Function Duration.....	571
K.9. Calculate Direct, Indirect Time-Element Losses per Occupant.....	572
K.10. Calculate Fraction of Residents Displaced from their Homes .....	574
K.11. Calculate Collapse Probability Based on Number of Collapsed Buildings, Total Building Area.....	574
K.12. Calculate Fraction of Buildings that are Red-Tagged, Number of Red-Tagged Buildings as a Factor of Total Building Area.....	578
K.13. Calculate Fraction of Buildings that are Yellow-Tagged, Number of Buildings that are Yellow-Tagged as a Factor of Total Building Area.....	578
K.14. Calculate Persons Trapped in Collapsed Buildings as a Fraction of all Indoor Occupants .....	578
K.15. Tabulating Vulnerability Functions.....	579
K.16. Statewide Weighted-Average Vulnerability Functions.....	582
K.17. Nationwide Weighted-Average Vulnerability Functions.....	584
K.18. Uncertainty Does Not Matter to BCR .....	585
K.19. Calculating BCR at the Census-Tract, County, State, and National Level.....	586
K.20. Aggregation to Counties .....	594
K.21. Aggregation to State Level.....	595
K.22. IEMax $I_e$ Value.....	596
K.23. Sensitivity Tests .....	596
<b>Appendix L. Reserved for Later Use .....</b>	<b>598</b>
<b>Appendix M. Evolution of Seismic Design Base Shear in Model Building Codes .....</b>	<b>599</b>
M.1. Introduction.....	599
M.2. Major Developments in UBC and IBC Base Shear Requirements .....	600
M.3. Cs Time Series.....	605
M.4. Observations and Conclusions.....	614
<b>Appendix N. Where Required Seismic Design Strength Exceeds Required Wind Strength.....</b>	<b>616</b>

## Table of Figures

<b>Figure 1:</b> Total costs and benefits of meeting the 2018 IRC and IBC.....	7
<b>Figure 2:</b> Total costs and benefits of new design to exceed select 2015 I-Code requirements and meet the 2015 IWUIC.....	7
<b>Figure 3:</b> Total costs and benefits resulting from leading private-sector residential retrofit measures.....	8
<b>Figure 4:</b> Total costs and benefits resulting from select utility and transportation lifeline mitigation efforts .....	8
<b>Figure 5:</b> Total costs and benefits of 23 years of federal mitigation grants.....	8

## NATURAL HAZARD MITIGATION SAVES:

Figure 6: BCR of coastal flooding mitigation by elevating new homes above 2015 IRC requirements (by state).....	11
Figure 7: BCR of hurricane wind mitigation by building new homes under the FORTIFIED Home Hurricane Program above 2015 IRC requirements (by wind band). ....	11
Figure 8: BCR of earthquake mitigation by increasing strength and stiffness in new buildings above the 2015 IRC and IBC requirements (by county). ....	12
Figure 9: BCR of WUI fire mitigation by implementing the 2015 IWUIC for new buildings (by county).....	12
Figure 10: BCR of hurricane wind mitigation by increasing roof strength in new buildings to meet the 2018 IRC and IBC (by wind band).....	13
Figure 11: BCR of earthquake mitigation by increasing strength and stiffness in new buildings (by county) to meet the 2018 IRC and IBC.....	13
Figure 12: Aggregate benefit by state from federal grants for flood, wind, earthquake, and fire mitigation.....	14
Figure 13: Stakeholder net benefits resulting from one year of constructing all new buildings to exceed select 2015 IBC and IRC requirements or to comply with 2015 IWUIC.....	18
Figure 14: Stakeholder net benefits per year of new construction resulting from meeting the 2018 IRC and IBC.....	19
Figure 15: Maximum level of the IBHS FORTIFIED Home Hurricane design for new construction where the incremental benefit remains cost effective. ....	21
Figure 16: Maximum strength and stiffness factor $I_e$ to exceed 2015 IBC and IRC seismic design requirements where the incremental benefit remains cost effective.....	21
Figure 2-1: Nationwide benefits by category for designing to exceed 2015 I-Code requirements for flood.....	41
Figure 2-2: BCR by sample county and additional elevation.....	43
Figure 2-3: BCR and $\Delta B/\Delta C$ to build new buildings higher above BFE than required by the 2015 IBC. ....	43
Figure 2-4: Benefits and costs of building new coastal houses in V-zones above 2015 I-Code requirements for 1 year. ....	45
Figure 2-5: BCR of coastal flooding mitigation by elevating homes above 2015 IRC requirements (by state).....	46
Figure 2-6: Benefits and costs of building new coastal single-family dwellings higher above the requirements of the 2015 IRC: (A) benefits versus costs, (B) BCR and $\Delta B/\Delta C$ versus first floor elevation. ....	47
Figure 2-7: BCR of hurricane wind mitigation by building new homes under the FORTIFIED Home Hurricane Program (by wind band). ....	51

Figure 2-8: Maximum level of the IBHS FORTIFIED Home Hurricane design for new construction where the incremental benefit remains cost effective. ....	52
Figure 2-9: Benefits and costs for 1 year of new construction at the IEMax IBHS FORTIFIED Home Hurricane levels. ....	52
Figure 2-10: BCR of hurricane wind mitigation by building new homes under the FORTIFIED Commercial Program (by wind band). ....	55
Figure 2-11: Benefits and costs for 1 year of new construction at the IEMax IBHS FORTIFIED Commercial Hurricane levels. ....	55
Figure 2-12: Benefits and costs for 1 year of new construction at the IEMax IBHS FORTIFIED Commercial Hurricane and IEMax IBHS FORTIFIED Home Hurricane levels. ....	57
Figure 2-13: Contribution to benefits from exceeding 2015 I-Code earthquake requirements. ....	58
Figure 2-14: BCR of earthquake mitigation by increasing strength and stiffness in new buildings (by county). ....	60
Figure 2-15 : Maximum strength and stiffness factor $I_e$ to exceed 2015 IBC and IRC seismic design requirements where the incremental benefit remains cost effective. ....	61
Figure 2-16: Population (millions) by county-level IEMax $I_e$ . ....	62
Figure 2-17: Contribution to benefits from 1 year of compliance with the 2015 IWUIC where it is cost effective to do so. ....	63
Figure 2-18: BCR of WUI fire mitigation by implementing the 2015 IWUIC for new buildings (by county). ....	64
Figure 2-19: (A) U.S. streams and rivers; (B) Gulf and Atlantic Coast hurricane winds; (C) seismic design load; (D) wildland fire potential. ....	68
Figure 2-20: U.S. population exposed to various combinations of earthquake, hurricane, and fire at the wildland-urban interface. ....	69
Figure 2-21: Sources of savings from I-Code adoption for flood. ....	71
Figure 2-22: Sources of savings from I-Code adoption for hurricane winds. ....	72
Figure 2-23: BCR for 1990-era construction designed instead to 2018 I-Codes. ....	73
Figure 2-24: Sources of savings from I-Code adoption for earthquake. ....	74
Figure 2-25: BCRs resulting from updating from 1990 construction to the strength and stiffness requirements of the 2018 I-Codes. ....	75
Figure 2-26: Benefits of the examined utility and transportation lifeline mitigation efforts. ....	76
Figure 2-27: Contribution to benefit from federally funded riverine flood grants. ....	77
Figure 2-28: Contribution to benefit from federally funded wind grants. ....	79
Figure 2-29: Contribution to benefit from federally funded earthquake mitigation grants. ....	80
Figure 2-30: Contribution to benefit from federally funded WUI fire mitigation grants. ....	83

Figure 2-31: Flood-related benefits from all the evaluated retrofits to flood-prone single-family dwellings. ....	85
Figure 2-32: Contribution flood-related benefits from the acquisition of flood-prone single-family houses. ....	86
Figure 2-33: Before (left) and after (right) elevation photos for a single-family house (Source: Stacy Wright).....	88
Figure 2-34: Illustration of a retrofit elevation of a wood-frame flood system house on a crawlspace (Source: FEMA P-259).....	88
Figure 2-35: Examples of elevated single-family house where the walls were separated from the slab and a new wood-framed floor system was constructed (Source: John Squerciati).....	89
Figure 2-36: Examples of elevated concrete slab single-family houses (Source: FEMA).....	89
Figure 2-37: Contribution flood-related benefits from retrofit elevation of flood-prone single-family dwellings. ....	90
Figure 2-38: A man cleans mud out of his basement after the floodwaters recede. (Source: FEMA Photo Library - Photo by Liz Roll/ FEMA News Photo, Photo by Liz Roll - May 14, 1996 - Location: Mt. Gay, WV).....	91
Figure 2-39: Wet floodproofed basement (Source: FEMA P-259 Figure 1-10).....	92
Figure 2-40: Contribution flood-related benefits from wet floodproofing basements of flood-prone single-family dwellings. ....	93
Figure 2-41: An example of an elevated air conditioning unit. (Source FEMA P-348 – Figure 3-1).....	94
Figure 2-42: An example of elevated air conditioning units and ductwork relocated from the below the lowest floor into the soffit (the underside) of the second floor. (Source FEMA P-348 – Figure 4-6).....	94
Figure 2-43: Contribution flood-related benefits from elevating air conditioning units or heat pumps and relocating ductwork for flood-prone single-family houses.....	95
Figure 2-44: Contribution flood-related benefits from relocating water heaters and furnaces located in basements or crawlspaces for flood-prone single-family dwellings.....	96
Figure 2-45: Contribution to benefits of IBHS FORTIFIED Hurricane Home retrofit for existing residential dwellings.....	98
Figure 2-46: Map of BCR for IBHS FORTIFIED Hurricane Home retrofit for existing residential buildings.....	98
Figure 2-47: Contribution to hurricane wind-related benefits from engineered tie-down systems for manufactured housing.....	100
Figure 2-48: Map of hurricane wind-related BCR from engineered tie-down systems for manufactured housing.....	101



<b>Figure 2-49:</b> Soft-story wood-frame multifamily dwellings. (A) Menlo Park, California. (B) Pasadena, California. (Photo credit: Porter 2006, used with permission.).....	102
<b>Figure 2-50:</b> Examples of collapsed soft-story wood-frame multifamily dwellings. (A) Collapsed apartment buildings in the San Francisco Marina District after the 1989 Loma Prieta earthquake (Image credit: R.B. Seed, 1989, via UC Berkeley NISEE, with permission). (B) Apartment building collapse after 1994 Northridge earthquake, associated with soft-story conditions (Image credit: UC Berkeley NISEE, 1994, with permission).....	102
<b>Figure 2-51:</b> Retrofit for soft-story wood-frame multifamily dwelling. (A) Cantilever columns added to garage openings, and (B) structural sheathing added to ground-story walls to strengthen soft-story multifamily wood-frame dwellings (Image credit: Applied Technology Council, with permission).....	103
<b>Figure 2-52:</b> Contribution to benefits of retrofitting soft-story wood-frame multifamily dwellings. ....	104
<b>Figure 2-53:</b> Map of BCR for retrofitting soft-story wood-frame multifamily dwellings.....	104
<b>Figure 2-54:</b> Earthquake damage to manufactured housing. (A): Overturned concrete piers that supported a manufactured house, viewed after the 1978 Santa Barbara earthquake. (B) and (C): Collapsed manufactured houses after the 1980 Livermore earthquake. (Images courtesy of National Information Service for Earthquake Engineering, University of California, Berkeley.) .....	105
<b>Figure 2-55:</b> Schematic illustration of an engineered tie-down system of manufactured housing. (Image by Henderson Consulting, 2013, used with permission from SPA Risk LLC). ....	105
<b>Figure 2-56:</b> Contribution to earthquake-related benefits from engineered tie-down systems for manufactured housing. ....	106
<b>Figure 2-57:</b> Map of earthquake-related BCR from engineered tie-down systems for manufactured housing.....	106
<b>Figure 2-58:</b> Contribution to benefits of securing hot water heaters to the building frame.....	108
<b>Figure 2-59:</b> Map of BCR from securing hot water heaters to the building frame. ....	108
<b>Figure 2-60:</b> Contribution to benefits of adding kitchen cabinet latches.....	109
<b>Figure 2-61:</b> Map of BCR from adding kitchen cabinet latches.....	109
<b>Figure 2-62:</b> Contribution to benefits of securing bookcases to the building frame. ....	110
<b>Figure 2-63:</b> Map of BCR from securing bookcases to the building frame. ....	110
<b>Figure 2-64:</b> Contribution to benefits of strapping freestanding monitors and televisions. ....	111
<b>Figure 2-65:</b> Map of BCR from strapping freestanding monitors and televisions. ....	111
<b>Figure 2-66:</b> Contribution to benefits of securing fragile objects with museum putty.....	112
<b>Figure 2-67:</b> Map of BCR from securing fragile objects with museum putty. ....	112
<b>Figure 2-68:</b> (A) Houses and (B) commercial buildings burned in the 2017 Tubbs Fire. (Image credits: (A) Frank Schulenberg 2017, (B) ATS 2017, both CC BY-SA 4.0) .....	113

Figure 2-69: BCR of WUI fire retrofit to comply with 2015 IWUIC for existing buildings, by county. ....	114
Figure 2-70: Contribution to benefits from retrofitting buildings to comply with the 2018 International Wildland-Urban Interface Code.....	115
Figure 2-71: Total costs and benefits of new design to exceed 2015 I-Code requirements.....	116
Figure 2-72: Total costs and benefits of 23 years of federal mitigation grants.....	117
Figure 2-73: Total costs and benefits of adopting 2018 I-Codes. ....	118
Figure 2-74: Aggregate benefit by state from federal grants for flood, wind, earthquake, and fire mitigation.....	119
Figure 2-75: Stakeholder net benefits resulting from 1 year of constructing all new buildings to exceed select 2015 IBC and IRC requirements or to comply with 2015 IWUIC.....	120
Figure 2-76: Stakeholder net benefits per year of new construction resulting from the last 30 years of code development. ....	121
Figure 2-77: Sensitivity of BCR for designing to exceed 2015 I-Code requirements for wind to major uncertain variables. ....	133
Figure 2-78: Diagram of sensitivity analysis of BCR for designing to exceed 2015 I-Code requirements for earthquake.....	135
Figure 2-79: Sensitivity tests for compliance with 2015 IWUIC. ....	136
Figure 3-1: Evolution of ridge, end, and corner zones for roof design pressures. ....	139
Figure 3-2: Examples of retrofit measures required by IBHS (A) Sealed roof deck over seams between roof sheathing, as required for FORTIFIED Roof. (B) Shutter installation required for FORTIFIED Silver. (C) Continuous load path required for FORTIFIED Gold. (photos used with permission from IBHS) .....	161
Figure 3-3: Wind zones for manufactured housing (Code of Federal Regulations Title 24 Section 3280.305).....	162
Figure 3-4: Occupants of manufactured homes tend to have lower household income than the general U.S. population, according to the U.S. Census Bureau (2017-KP1).....	168
Figure 3-5: Occupants of manufactured homes tend to have the same age distribution as the general U.S. population, according to the U.S. Census Bureau (2017-KP1).....	169
Figure 3-6: Leading options for improving the seismic resistance of manufactured housing and to reduce or prevent-post-earthquake fires. (A) Earthquake-resistant bracing system (ERBS), (B) engineered tie-down system (ETS), (C) perimeter wall and footing, (D) securing water heater, and (E) adding a flexible connection between the gas line and manufactured home, along with an automatic gas shut-off valve. (Images by Henderson Consulting, 2013, and courtesy of SPA Risk LLC, used with permission.).....	170
Figure 3-7: Damage to contents common to residences. (A) overturned bookcase with fallen contents (Rhiannon Harris on January 22, 2015, with permission; <a href="https://triadfellowship.wordpress.com/2015/01/22/hokudan-earthquake-memorial-">https://triadfellowship.wordpress.com/2015/01/22/hokudan-earthquake-memorial-</a>	

park-and-nagoya-flower-market/) (B) contents spilled from cabinets and countertops in a kitchen near the Northridge Fashion Center after the 1994 Northridge earthquake (Photo Credit: J. Dewey, U.S. Geological Survey.) (C) Overturned desktop contents after the 2018 Anchorage, Alaska earthquake (Alaska Department of Transportation and Public Facilities - CC BY-SA 2.0, <https://commons.wikimedia.org/w/index.php?curid=74853821>), and (D) residential water heater (California Seismic Safety Commission 2005).....172

<b>Figure 3-8:</b> U.S. Fire Administration Wildland-Urban Interface (WUI) toolkit website. (public domain).....	176
<b>Figure 3-9:</b> National Fire Protection Association Firewise USA website.....	176
<b>Figure 3-10:</b> Insurance Institute for Business & Home Safety Protect Your Home from Wildfire website.....	177
<b>Figure 3-11:</b> West Region Wildfire Council (Colorado) website.....	177
<b>Figure 3-12:</b> Example materials for public dissemination regarding making homes more fire resistive.....	178
<b>Figure 3-13:</b> Camp Fire smoke at the Bay Bridge in San Francisco, California. Left: San Francisco Oakland Bay Bridge on November 16, 2018 during the Camp Fire. Right: same place on October 14, 2018. (Source: James R Morrin Jr CC BY-SA 4.0).....	179
<b>Figure 3-14:</b> Camp Fire smoke dispersion across U.S. (Source: NOAA, accessed 20 March 2019 from <a href="https://www.sfgate.com/california-wildfires/article/camp-fire-smoke-noaa-maps-nyc-texas-paradise-13408526.php#photo-16533579">https://www.sfgate.com/california-wildfires/article/camp-fire-smoke-noaa-maps-nyc-texas-paradise-13408526.php#photo-16533579</a> ).....	179
<b>Figure 4-1:</b> An engineering approach to risk analysis (image credit: Porter 2017, used with permission).....	192
<b>Figure 4-2:</b> Location and count of RES1 tracts from 2010 Census (Houston, TX is shown in the center).....	211
<b>Figure 4-3:</b> Location of Manufactured Housing Complexes per the U.S. Department of Homeland Security.....	212
<b>Figure 4-4:</b> Fragility function and collapse data for manufactured housing in the epicentral region of the 1989 Loma Prieta earthquake.....	217
<b>Figure 4-5:</b> Vulnerability functions for manufactured housing without an engineered tie-down system.....	218
<b>Figure 4-6:</b> Typical residential water heater.....	224
<b>Figure 4-7:</b> Overturning of rigid blocks (after Kostanidis and Makris 2010).....	225
<b>Figure 4-8:</b> Northridge Earthquake injuries. "HH" indicates number of households in which at least one person experienced this level of injury (Porter et al. 2005 after Seligson and Shoaf 2003).....	228

Figure 4-9: Incremental benefits and costs when evaluating a range of possible degrees of mitigation investment. ....	231
Figure 4-10: Stratified sampling scheme for federal mitigation grants. ....	233
Figure 4-11: Methodology to estimate BCR for designs exceeding I-Code requirements for riverine flood.....	234
Figure 4-12: Use of Hazus to estimate benefits and costs of federal grants for riverine flood.....	235
Figure 4-13: Census tracts near downtown Oakland, California. ....	238
Figure 4-14: Locations used to determine BCRs for riverine flood. ....	242
Figure 4-15: Sample data for adjusting NOAA MOMs surge elevations (National Hurricane Center 2014) to FEMA FIS estimates, Pinellas County, Florida (Federal Emergency Management Agency 2009b). ....	252
Figure 4-16: South Florida wind speed combination example. ....	254
Figure 4-17: ASCE 7-16 700-year wind speeds. ....	256
Figure 4-18: Sample calculation of Vs30 using OpenSHA site data application.....	261
Figure 4-19: (A) Spatial interpolation of site hazard followed by (B) factoring for site effects. ....	263
Figure 4-20: FEMA P-154 (Federal Emergency Management Agency 2015e) seismicity regions. ....	265
Figure 4-21: (A) USFS BPs with four study counties indicated. (B) USFS 2014 wildfire hazard potential, plus water and non-burnable areas. ....	267
Figure 4-22: Number of U.S. counties in the conterminous United States by 2017 Interim Report fire hazard stratum.....	267
Figure 4-23: Capacity spectrum method of structural analysis.....	281
Figure 4-24: Event tree for inoperability decomposition.....	292
Figure 4-25: Inoperability event trees: A) sample baseline scenario, B) mitigated scenario.....	292
Figure 4-26: Indirect BI loss for every \$1 of direct BI loss in each Hazus building occupancy class. ....	296
Figure 4-27: Overhead factor y for NFIP flood insurance.....	301
Figure 4-28: Some intangibles that are not quantified here: A) Continuity of life's arc. B) Heirlooms. C) Culture. D) Disproportionate impacts on vulnerable populations. E) Pets. F) Ecosystems. [Image credits: A, B, E and F: Public domain. C: Elisa Rolle, CC-BY-SA3.0. D: Matty1378, CC-BY-SA3.0.].....	305
Figure 5-1: FEMA hazard mitigation programs (Federal Emergency Management Agency 2017a).....	317
Figure 5-2: Flood project amounts in thousands of grant-year dollars.....	322
Figure 5-3: Wind project amounts in thousands of grant-year dollars. ....	323
Figure 5-4: Earthquake project amounts in thousands of grant-year dollars. ....	323
Figure 5-5: Fire project amounts in thousands of grant-year dollars.....	324
Figure 5-6: Commercial building depth-damage functions used for analysis.....	328

Figure 5-7: One-story single-family building depth damage function compilation example.....	329
Figure 5-8: Two-story single-family building depth damage function compilation example.....	330
Figure 5-9: Example of dasymmetrically adjusted census block polygons.....	333
Figure 5-10: Example of UDF inventory.....	334
Figure 5-11: Locations of grants selected for the analysis of the effectiveness of flood-prone structure acquisitions.....	342
Figure 5-12: Depth-damage functions for one-story houses.....	351
Figure 5-13: Depth-damage functions for two-story houses.....	352
Figure 5-14: Scenario benefit-cost ratios of installing ETS on unanchored manufactured homes in the Florida panhandle, given (A) 700-year wind speeds and (B) 1,700-year wind speeds.....	367
Figure 5-15: Incremental costs and benefits of seismic design provisions.....	369
Figure 5-16: Proportional cost of new office building construction and impact on construction costs associated with increasing lateral strength.....	371
Figure 5-17: Locations of sample high-hazard earthquake mitigation projects.....	376
Figure 5-18: Gresham Fire Station 74 (A) in Google Earth Street View, and (B) from above.....	377
Figure 5-19: Tornado diagram for BCR of strapping water heaters to the building frame.....	380
Figure 6-1: Elevated rail in Coralville, Iowa.....	386
Figure 6-2: Estimated benefits from elevated rail and trails in Coralville, Iowa.....	388
Figure 6-3: Elevated rail (green highlight) in the SEMO Port Railroad.....	389
Figure 6-4: Estimated benefits from elevating rail near SEMO Port, Missouri.....	390
Figure 6-5: Elevated and extended road in Seward, Nebraska.....	391
Figure 6-6: Estimated benefits from elevated access road in Seward, Nebraska.....	392
Figure 6-7: Elevated roadway (North Dubuque Street, highlighted by the red line) and elevated bridge (Park Road Bridge over the Iowa River, yellow pushpin) in Iowa City, Iowa.....	393
Figure 6-8: Estimated benefits of elevating access road and reconstructing bridge in Iowa City, Iowa.....	394
Figure 6-9: Reconstructed bridge (yellow pushpin) over Main Road in Ruidoso, New Mexico.....	395
Figure 6-10: Estimated benefits from reconstructing the Main Road Bridge over Rio Ruidoso in Ruidoso, New Mexico.....	396
Figure 6-11: Portsmouth’s water treatment plant: A) in 2003, and B) in 2015.....	397
Figure 6-12: Estimated benefits from elevating electrical equipment at the water treatment plant in Portsmouth, Virginia.....	398
Figure 6-13: The old water treatment plant in Columbus Junction, Iowa.....	399
Figure 6-14: The new water treatment plant in Columbus Junction, Iowa.....	399
Figure 6-15: Estimated benefits from new water treatment plant in Columbus Junction, Iowa.....	401

Figure 6-16: Wastewater treatment plant sites in Iowa City, Iowa : the north plant (denoted 468 north WWTP) and the south plant (denoted 468 south WWTP).....	402
Figure 6-17: The estimated extent of flooding at the south waste water treatment plant in Iowa City, Iowa, before mitigating sensitive buildings and components, using a 0.2% annual exceedance probability (500-year flood). (Stanley Consultants 2011).....	403
Figure 6-18: Estimated benefits from decommissioning the Iowa City, Iowa, north wastewater treatment plant and elevating or otherwise protecting critical equipment at the south plant.....	405
Figure 6-19: A. Water treatment plant (denoted 53 WTP) and wastewater treatment plant (denoted 53 WWTP) sites in Greenville, North Carolina. B. Image of the water treatment plant, with berm highlighted in red. C. Image of the wastewater treatment plant.....	406
Figure 6-20: Estimated benefits from adding flood protection to the water and wastewater treatment plants in Greenville, North Carolina. ....	408
Figure 6-21: Electrical and telephone switching stations in Reedsburg, Wisconsin. The old one is to the right with the green cabinet next to it; the new one is to the left, behind the pickup truck.....	408
Figure 6-22: Estimated benefits from new telephone and electrical switching building in Reedsburg, Wisconsin. ....	410
Figure 6-23: Annual Frequency versus Wind Speed (mph) for Derby-West Charleston & Bloomfield to Canaan.....	412
Figure 6-24: Power pole fragility model for wind effects (Shafieezadeh et al., 2014).....	413
Figure 6-25: Schematic of water supply network.....	422
Figure 6-26: Frequency plot of U.S. cities with population greater than 100,000.....	424
Figure 6-27: Distribution of 50 largest U.S. city populations, mean (998,000) and median (646,000).....	425
Figure 6-28: Study grid.....	426
Figure 6-29: Data on 2005-2010 domestic water use for selected U.S. cities.....	429
Figure 6-30: Water network Case 1: first round of initial design.....	431
Figure 6-31: Water network Case 2: second round of initial design.....	432
Figure 6-32: Water network Case 3.....	433
Figure 6-33: Water network Case 4.....	433
Figure 6-34: Water network Case 5.....	434
Figure 6-35: Water network Case 6.....	435
Figure 6-36: Water network Case 7.....	436
Figure 6-37: Water network Case 8.....	436
Figure 6-38: Water network Case 5A, no fire flow.....	437

Figure 6-39: Distribution of pipe diameters for as-is and selected water districts.....	440
Figure 6-40: Distribution of pipe materials for selected water districts.....	440
Figure 6-41: City of Los Angeles, with potential liquefaction zones shown in red.....	443
Figure 6-42: City of San Francisco, with hazard zones (almost entirely liquefaction, some landslide in the middle of the city) shown in red.....	443
Figure 6-43: EBMUD liquefaction zones (Porter 2018).....	444
Figure 6-44: City of Seattle liquefaction zones.....	444
Figure 6-45: City of Portland liquefaction zones.....	445
Figure 6-46: MMI 6 with as-is design.....	453
Figure 6-47: MMI 7, as-is design.....	454
Figure 6-48: MMI 8 as-is design. sustains 111 distribution and 9 trunk line repairs, and 21 ignitions occur.....	456
Figure 6-49: MMI 8, nodal pressure distributions at end of Day 1, when all fires out, all trunk line repairs and 17 distribution line repairs are completed, and 94 remain.....	457
Figure 6-50: MMI 9, as-is design sustains 205 distribution and 14 trunk line repairs, and 59 ignitions occur.....	458
Figure 6-51: MMI 9, cumulative repairs and service restoration vs. days after event.....	459
Figure 6-52: Annual frequency of MMI for Los Angeles, San Francisco, Portland and Seattle, Vs 300 mps.....	462
Figure 6-53: Importance of electric power and critical infrass dependencies (DOE 2017).....	466
Figure 6-54: Schematic representation of the U.S. electric power system. (Adapted from DOE 2017).....	468
Figure 6-55: Risks to electricity sector resilience from current threats. (DOE 2017).....	469
Figure 6-56: Schematic representation of the U.S. electric power system showing EHV substations as a critical link. Adapted from DOE (2017).....	470
Figure 6-57: Electric transmission (138 kV and greater) overland on NERC regions.....	472
Figure 6-58: Substations (138 kV and larger voltage) overland on CABS, greater than 100,000 population.....	472
Figure 6-59: Substation schematic.....	473
Figure 6-60: Substations (138 kV and larger voltage) overland on CBSA and peak ground acceleration (PGA, 2% probability of exceedance in 50 years), southwestern United States.....	474
Figure 6-61: Substation seismic fragility – probability of Complete damage state if unanchored (U), anchored (A) to 0.47g design, and anchored to 1.0g design.....	475
Figure 6-62: Annual frequency of PGA for (A) Los Angeles, (B) San Francisco, (C) Portland, and (D) Seattle.....	479

Figure 6-63: REDARS methodology flowchart.....	481
Figure 6-64: Los Angeles study region.....	482
Figure A-1: Jevreja et al. (2014) estimated the probability distribution function of GSL by the year 2100.....	539
Figure 7-2: Corner period TAVD for M=7, R=20 km, soil=D, versus effective damping ratio.....	560
Figure A-3: Illustration of probabilistic damage state for structural components.....	565
Figure A-4: $C_s$ time series for San Francisco site, low-rise construction, various NEHRP site classes.....	607
Figure A-5: $C_s$ time series for San Francisco site, NEHRP site class C, various heights.....	610
Figure A-6: $C_s$ time series for various locations, low-rise construction, NEHRP site class C.....	612
Figure A-7: The long-term trend in design base shear suggests 4% increase per 3-year code cycle, or 50% per 30 years. With constant drift limits, stiffness has increased in proportion.....	615
Figure A-8: Basic wind speed from ATC hazard tool.....	617
Figure A-9: County maximum values of $S_{MS}$ where $C_s$ exceeds $F_{wind}$ .....	619

## Table of Tables

Table 1: Benefit-Cost Ratio by Hazard and Mitigation Measure.....	2
Table 2: Costs and benefits associated with constructing new buildings in one year to exceed select 2015 I-Code requirements or adopt the 2015 IWUIC (in \$ billions).....	9
Table 3: Costs and benefits associated with constructing new buildings to meet the 2018 IRC and IBC (in \$ billions).....	9
Table 4: Costs and benefits associated with 23 years of federal grants (in \$ billions).....	10
Table 5: BCRs for various heights above BFE for new coastal V-zone buildings.....	20
Table 1-1: Retrofit measures to be examined in the ongoing study.....	35
Table 2-1: Benefit-cost ratio by Hazard and Mitigation Measure.....	37
Table 2-2: Summary BCR results for sampled counties.....	42
Table 2-3: Benefits and costs of building new coastal 1-story single-family dwellings higher above estimated BFE (all dollar figures in present value, \$ millions, for 1 year of new construction).....	46
Table 2-4: Summary of IEMax elevations above BFE for new buildings in coastal V-zones, by state, for 1 year of new construction.....	47
Table 2-5: Benefits and costs for 1 year of new construction at IEMax IBHS FORTIFIED Home Hurricane levels (millions).....	51
Table 2-6: Benefits and costs for 1 year of new construction at the IEMax IBHS FORTIFIED Commercial Hurricane levels.....	54



Table 2-7: Benefits and costs for 1 year of new construction at the IEMax IBHS FORTIFIED Home Hurricane and IEMax IBHS FORTIFIED Commercial Hurricane levels.....	56
Table 2-8: Top-10 counties for designing to exceed 2015 I-Code earthquake requirements.....	61
Table 2-9: Population distribution by county-level IEMax $I_e$ .....	62
Table 2-10: Incentives to implement designing to exceed 2015 I-Code requirements for typical (Risk Category II) buildings.....	65
Table 2-11: Population exposed to high risk from flood, hurricane, earthquake, or fire at the wildland-urban interface.....	68
Table 2-12: Costs and benefits of sampled grants for riverine flood acquisitions (in thousands).....	78
Table 2-13: Costs and benefits of sampled federal grants to mitigate wind damage (in millions). ....	79
Table 2-14: BCR per wind band for the FORTIFIED IEMax, Roof, Silver and Gold IBHS Designation.....	99
Table 2-15: Summary of benefits and costs of mitigation for residential furnishings, fixtures, equipment, and contents.....	107
Table 2-16: Costs and benefits associated with constructing new buildings in 1 year to exceed 2015 I-Code requirements (in \$ billions). ....	116
Table 2-17: Costs and benefits associated with 23 years of federal grants (in \$ billions).....	117
Table 2-18: Costs and benefits associated with constructing new buildings in 1 year to adopt 2018 I-Code requirements (in \$ billions). ....	118
Table 2-19: Total BCR of exceeding 2015 I-Codes at various discount rates.....	123
Table 2-20: Total BCR of federal mitigation grants at various discount rates.....	123
Table 2-21: Total Incremental BCR of adopting 2018 I-Codes from the identified baselines at various discount rates.....	123
Table 2-22: Total cost, benefit, and BCR of exceeding 2015 I-Codes, using a 3% discount rate.....	124
Table 2-23: Total cost, benefit, and BCR of federal mitigation grants, using a 3% discount rate.....	124
Table 2-24: Total cost, benefit, and BCR of adopting 2018 I-Codes from various baselines and geographic areas, using a 3% discount rate.....	125
Table 2-25: Total cost, benefit, and BCR of exceeding 2015 I-Codes using a 7% discount rate.....	125
Table 2-26: Total cost, benefit, and BCR of federal mitigation using a 7% discount rate.....	126
Table 2-27: Total cost, benefit, and BCR of adopting 2018 I-Codes from various baselines and geographic areas using a 7% discount rate.....	126
Table 2-28: Factor $f$ used to estimate savings to the Federal Treasury.....	128
Table 2-29: Estimated annual savings to the Federal Treasury resulting from the four categories of natural hazard mitigation examined here.....	130
Table 2-30: Sensitivity of the BCR for greater elevation of new coastal buildings to sea level rise (Low, Intermediate-low, intermediate-high, and extreme).....	131

Table 2-31: Sensitivity of the BCR for greater elevation of new coastal buildings to other input variables. ....	132
Table 2-32: Sensitivity of BCR for adopting IBHS FORTIFIED Home and Commercial Hurricane to three important inputs.....	132
Table 2-33: Sensitivity of BCR for designing to exceed 2015 I-Code earthquake requirements to various uncertain parameters. ....	134
Table 3-1: Comparison of allowable stress design wind loads (3-second gusts). ....	139
Table 3-2: Comparison of commercial roof design pressures. ....	140
Table 3-3: Comparison of residential roof design pressures. ....	140
Table 3-4: Flood damage mitigation strategies and general cost effectiveness, based on Federal Emergency Management Agency (2015).....	147
Table 3-5: Summary table of flood mitigation options considered for single-family houses subject to riverine flooding.....	156
Table 4-1: Selected mitigation strategies for exceeding I-Code requirements. ....	200
Table 4-2: Benefit categories associated with each flood retrofit option.....	201
Table 4-3: Age Distribution by Census Division .....	213
Table 4-4: Manufactured housing performance in the 1989 Loma Prieta earthquake. ....	216
Table 4-5: Fraction of manufactured housing units not anchored to their foundation. Units not reporting anchorage condition are not shown in the table. ....	219
Table 4-6: Residential retrofit measures and parameter values .....	229
Table 4-7: Options for exposure data.....	236
Table 4-8: Four building sizes used to determine BCRs for riverine flood. ....	241
Table 4-9: Foundation and elevations used to determine BCRs for riverine flood. ....	242
Table 4-10: Portfolio of foundation type (open or closed) and house size (stories and total area) by county, used to determine BCRs for riverine flood.....	242
Table 4-11: Assigning foundation type to riverine flood proxy portfolio. ....	244
Table 4-12: Assigning model label to riverine flood proxy portfolio buildings based on size and foundation.....	244
Table 4-13: Assigning a case identifier to riverine flood proxy portfolio buildings based on size, foundation, and depth. ....	244
Table 4-14: Number of buildings by county and size-foundation-depth case in sampled census blocks of the riverine flood proxy portfolio. ....	245
Table 4-15: Estimated building occupancy for riverine flooding. ....	247
Table 4-16: Hazard measures and sources. ....	248

Table 4-17: Population-weighted wind speeds (mph) by return interval, given 700-year wind speed contours. ....	255
Table 4-18: NEHRP site classes and associated Vs30, used for estimating design requirements.....	257
Table 4-19: NEHRP site classes and boundary classes with Vs30, used for estimating hazard.....	258
Table 4-20: Site coefficient Fa as a function of Sa(0.2 sec, 5%) on site class BC, denoted hs. ....	258
Table 4-21: Site coefficient Fv as a function of Sa(1.0 sec, 5%) on site class BC, denoted h1. ....	259
Table 4-22: Sample calculation of G for Sa(1.0 sec, 5%, BC) = 0.0025g.....	262
Table 4-23: Definition of FEMA P-154 (Federal Emergency Management Agency 2015e) seismicity regions. ....	264
Table 4-24: Mapping 2014 USFS WHP to the 2017 <i>Interim Report</i> fire hazard strata for purposes of sample stratification. ....	266
Table 4-25: Hazus modeling of IBHS FORTIFIED Home Hurricane and 2015 IRC for basic wind speed < 115 mph. ....	272
Table 4-26: Hazus modeling of IBHS FORTIFIED Home Hurricane and 2015 IRC for basic wind speeds of 115-130 mph.....	273
Table 4-27: Hazus modeling of IBHS FORTIFIED Home Hurricane and 2015 IRC for basic wind speeds of 130-140 mph and more than 1 mile from coast. ....	274
Table 4-28: Hazus modeling of IBHS FORTIFIED Home Hurricane and 2015 IRC for basic wind speed at least 130 mph and less than 1 mile from coast, or based wind speed at least 140 mph regardless of coastal distance.....	275
Table 4-29: Selection of method to estimate seismic vulnerability.....	279
Table 4-30: Hazus building occupancy classes (Federal Emergency Management Agency 2012). ....	289
Table 4-31: Relating IO sectors with Hazus occupancy classes.....	291
Table 4-32: Data sources and assumptions for the four resilience tactics.....	295
Table 4-33: Output loss per day of downtime VBI and per-dollar indirect BI loss Q.....	298
Table 4-34: Acceptable cost to avoid a statistical injury, with injuries measured by AIS. ....	302
Table 4-35: Acceptable cost to avoid a statistical injury, with injuries measured by Hazus injury severity.....	302
Table 4-36: Benefit-transfer matrix A. ....	313
Table 4-37: U.S. job-creation data for designing to exceed I-Code requirements for earthquake. ....	316
Table 5-1: Agencies and programs providing grant data. ....	318
Table 5-2: Integrated project database format. ....	319
Table 5-3: Summary of grant data, in grant-year dollars.....	321
Table 5-4: Total project costs in billions. ....	321
Table 5-5: Median and mean project amounts in project-year dollars.....	322

Table 5-6: Table of hypothetical elevations for idealized floodplains. ....327

Table 5-7: Value of 1 year of new construction in the floodplain.....331

Table 5-8: Benefit from 1 year of nationwide incorporation of freeboard through adoption of the I-Codes. ....332

Table 5-9: Estimated costs to build new buildings higher to reduce risk from riverine flood.....335

Table 5-10: Mapping from grants database to Hazus occupancy classes for riverine flood.....335

Table 5-11: Hazus estimates of average building area.....337

Table 5-12: Calculating building replacement cost for public-sector riverine flood mitigation.....338

Table 5-13: Hazus square-foot replacement costs.....339

Table 5-14: Distribution of occupancies within sampled flood grants.....342

Table 5-15: Estimated number of occupants per building for use in estimating benefits of grants to mitigate riverine flooding. ....344

Table 5-16: Table of hypothetical elevations for idealized floodplains.....346

Table 5-17: Table of foundation types assigned to each Numbered A Zone per lowest floor elevation designation.....349

Table 5-18: Summary of acquisition BCRs by discount rate. ....353

Table 5-19: Foundation types evaluated for retrofit elevation analysis. Slab = Slab-on-grade and CS = Crawlspace.....354

Table 5-20: BCRs for flood elevation retrofit for each of three discount rates. ....356

Table 5-21: BCR for wet floodproofing existing houses, by discount rate. ....358

Table 5-22: BCRs to relocate air conditioners or heat pumps and their associated ductwork, by discount rate.....359

Table 5-23: BCRs to relocate furnaces and water heaters, by discount rate.....360

Table 5-24: Estimated nationwide BCR of flood retrofits, by discount rate. ....360

Table 5-25: Sensitivity of BCR to discount rate for IBHS FORTIFIED Home Retrofit .....364

Table 5-26: Sensitivity of BCR to effective life for IBHS FORTIFIED Home Retrofit.....365

Table 5-27: Sensitivity of BCR to discount rate for engineered tie-down systems.....365

Table 5-28: Sensitivity of BCR to design life for engineered tie-down systems.....365

Table 5-29: Sensitivity of BCR to retrofit cost for engineered tie-down systems.....366

Table 5-30: Sensitivity of BCR to the inclusion of different eras of construction. ....366

Table 5-31: Long-term benefits of adopting modern seismic design requirements. ....368

Table 5-32: Options for seismic vulnerability of buildings. ....372

Table 5-33: Sensitivity of BCR to discount rate for soft-story retrofit.....378

Table 5-34: Sensitivity of BCR to discount rate for engineered tie-down systems.....379

Table 5-35: Sensitivity of BCR to design life for engineered tie-down systems.....	379
Table 5-36: Sensitivity of BCR to discount rate for residential retrofit measures. ....	379
Table 5-37: Estimated cost to retrofit an existing home to comply with the 2018 International Wildland-Urban Interface Code. ....	382
Table 6-1: Casualty modeling for flooded roads.....	387
Table 6-2: Wind speeds versus mean recurrence intervals for Vermont and Texas alignments.....	411
Table 6-3: Pole failure probabilities (Derby to West Charleston alignment).....	416
Table 6-4: Damaged (Derby to West Charleston alignment).....	416
Table 6-5: Days to full service restoration (Derby to West Charleston alignment). ....	416
Table 6-6: EAL from wind and ice damage to poles (Derby to West Charleston alignment). ....	417
Table 6-7: Pole failure probabilities (Bloomfield to Canaan alignment). ....	417
Table 6-8: Damage (Bloomfield to Canaan alignment). ....	418
Table 6-9: Number of days to full service restoration (Bloomfield to Canaan alignment).....	418
Table 6-10: EAL due to wind and ice damage to poles (Bloomfield to Canaan alignment).....	418
Table 6-11: Total EAL for Project 1 by loss type.....	418
Table 6-12: BCRs for undergrounding Vermont alignments, by time horizon. ....	419
Table 6-13: Pole failure probabilities (Seabrook, Texas alignment). ....	419
Table 6-14: Damage (Seabrook, Texas alignment). ....	420
Table 6-15: Days to full restoration (Seabrook, Texas alignment). ....	420
Table 6-16: EALs from wind damage to poles (Seabrook, Texas alignment). ....	421
Table 6-17: BCRs for undergrounding by time horizon (Seabrook, Texas alignment). ....	421
Table 6-18: Parameters and acronyms used in the study and their values. ....	426
Table 6-19: Phase 1 as-is design results. ....	438
Table 6-20: Comparison of as-is design and city of San Francisco water distribution parameters. ....	439
Table 6-21: Distribution of pipe diameters for as-is and selected water districts. ....	439
Table 6-22: Distribution of pipe materials for selected water districts.....	440
Table 6-23: Maximum possible repairs per day.....	446
Table 6-24: U.S. fire statistics 2003-2015 (USFA 2018). ....	451
Table 6-25: Results for as-is system for increasing seismic intensity.....	460
Table 6-26: Summary of losses and benefits with and without resilient grid given MMI shaking (\$ millions).....	461
Table 6-27: Summary of benefits and BCR, four West Coast cities (cost-of-borrowing discount rate of 2.2%). ....	463
Table 6-28: Summary of resilient watergrid BCRs for several discount rates, four West Coast cities.....	465

Table 6-29: Blackout initiating events NERC data 1986-2003, from (Hines et al. 2008).....	467
Table 6-30: Fragility and median duration of outage, high voltage substations (FEMA 2003).....	474
Table 6-31: Benefits and costs of seismically retrofitting an existing electric substation in four West Coast cities.....	480
Table 6-32: Fatalities due to bridge collapse between 1970 and 2018.....	483
Table A-1: Fields from HMGP grants database.....	528
Table A-2: Mapping PA data to the 2017 Interim Report study data.....	529
Table A-3: Options for how to deal with changes in PA grants after 2005.....	532
Table A-4: Global sea-level rise projections.....	538
Table A-5: LSL relative to year 2000, in feet, based on Kopp et al. (2014) projections.....	539
Table A-6: 2017 Interim Report oversight committee.....	544
Table A-7: Capacity curve parameters.....	553
Table A-8: Values of ductility capacity $\mu$ .....	555
Table A-9: Damping coefficients $\kappa$ for medium-duration ( $5.5 \leq M < 7.5$ ) earthquakes and high-code buildings.....	556
Table A-10: $F_a$ as a function of SA02.....	560
Table A-11: $F_v$ as a function of SA10BC for site class D.....	561
Table A-12: $F_a$ as a function of SA02BC for site class D.....	562
Table A-13: $F_v$ as a function of SA10 for site class D.....	563
Table A-14: Structural repair costs as a fraction for building replacement cost (new), $L_d, s$ .....	567
Table A-15: Nonstructural drift-sensitive repair costs as a fraction for building replacement cost (new), $L_d, n_d$ .....	568
Table A-16: Nonstructural acceleration-sensitive repair costs as a fraction for building replacement cost new, $L_d, n_a$ .....	569
Table A-7-17: Content damage factors conditioned on acceleration-sensitive damage states.....	570
Table A-18: The injury severity levels in Hazus.....	571
Table A-19: Output loss per day of downtime VBI and per-dollar indirect BI loss Q.....	572
Table A-20: Response modification coefficients R.....	576
Table A-21: Average building area $A_{avg}$ (square feet per building) inferred from Hazus.....	577

## Summary of Findings

### BCRs for Mitigation Strategies Studied

(from Highest to Lowest)

- Adopting Model Codes Saves \$11 per \$1 Spent
- Federal Mitigation Grants Save \$6 per \$1 Spent
- Private-Sector Building Retrofit Saves \$4 per \$1 Spent
- Exceeding Codes Saves \$4 per \$1 Spent
- Mitigating Infrastructure Saves \$4 per \$1 Spent

Natural hazards present significant risks to many communities across the United States. Fortunately, there are measures that governments, building owners, developers, tenants, and others can take to reduce the impacts of such events. These measures—commonly called mitigation—can result in significant savings in terms of safety, and preventing property loss and disruption of day-to-day life.

Given the rising frequency of disaster events and the increasing cost of disaster recovery across the nation, mitigation actions are crucial for saving money, property, and, most importantly, lives. Activities designed to reduce disaster losses also may spur job growth and other forms of economic development.

Mitigation represents a sound financial investment. This study examined five sets of mitigation strategies and found that society enjoys a benefit-cost ratio (BCR) of 11:1 for adopting the 2018 *International Residential Code (IRC)* and *International Building Code (IBC)*, the model building codes developed by the International Code Council (also known as the I-Codes), versus codes represented by 1990-era design; a BCR of 4:1 for investments to exceed select provisions of the 2015 *IRC* and *IBC*; a BCR of 4:1 for a variety of common retrofit measures for private-sector buildings; a BCR of 4:1 for a select number of utilities and transportation infrastructure study cases; and a BCR of \$6 for every \$1 spent through mitigation grants funded through select federal agencies.





Just implementing above-code design for one year and carrying out the last 23 years of federally supported mitigation grants will ultimately prevent 600 deaths, 1 million nonfatal injuries, and 4,000 cases of post-traumatic stress disorder (PTSD) in the long term. In addition, designing new buildings to exceed the 2015 *IRC* and *IBC* would result in 87,000 new, long-term jobs, and an approximate 1% increase in

## NATURAL HAZARD MITIGATION SAVES:

utilization of domestically produced construction materials.<sup>1</sup> Communities that consistently meet the latest editions of commonly adopted code requirements, culminating in the 2018 IRC and IBC, have added 30,000 new jobs to the construction-materials industry and an approximate 0.3% increase in utilization of domestically produced construction materials for each year of new construction over what it would have been if buildings were designed as they were in 1990.

The study examined four specific natural hazards: riverine and coastal flooding, hurricanes, earthquakes, and fires at the wildland-urban interface (WUI). The national-level BCRs aggregate the study findings across these natural hazards and across state and local BCRs. Table 1 provides BCRs for each natural hazard the project team examined.

**Table 1:** Benefit-Cost Ratio by Hazard and Mitigation Measure.

	ADOPT CODE	ABOVE CODE	BUILDING RETROFIT	LIFELINE RETROFIT	FEDERAL GRANTS
<b>Overall Benefit-Cost Ratio</b>	<b>11:1</b>	<b>4:1</b>	<b>4:1</b>	<b>4:1</b>	<b>6:1</b>
<b>Cost (\$ billion)</b>	<b>\$1/year</b>	<b>\$4/year</b>	<b>\$520</b>	<b>\$0.6</b>	<b>\$27</b>
<b>Benefit (\$ billion)</b>	<b>\$13/year</b>	<b>\$16/year</b>	<b>\$2200</b>	<b>\$2.5</b>	<b>\$160</b>
 <b>Riverine Flood</b>	<b>6:1</b>	<b>5:1</b>	<b>6:1</b>	<b>8:1</b>	<b>7:1</b>
 <b>Hurricane Surge</b>	not applicable	<b>7:1</b>	not applicable	not applicable	not applicable
 <b>Wind</b>	<b>10:1</b>	<b>5:1</b>	<b>6:1</b>	<b>7:1</b>	<b>5:1</b>
 <b>Earthquake</b>	<b>12:1</b>	<b>4:1</b>	<b>13:1</b>	<b>3:1</b>	<b>3:1</b>
 <b>Wildland-Urban Interface Fire</b>	not applicable	<b>4:1</b>	<b>2:1</b>	not applicable	<b>3:1</b>

Copyright © 2019 The National Institute of Building Sciences

The study quantifies many, but not all, of the important benefits of mitigation. Mitigation activities save more than what is estimated in this report. Disasters disconnect people from friends, schools, work, and familiar places. They ruin family photos and heirlooms and alter relationships. Large disasters may cause permanent harm to one's culture and way of life, and greatly impact the most socially and financially marginal people. Disasters may have long-term consequences to the health and collective well-being of those affected. Such events often hurt or kill pets and destroy natural ecosystems that are integral parts of

<sup>1</sup> Higher construction costs might also cost jobs if they make new homes less affordable, unless the higher cost of homes is offset by incentives as described in the section, "Incentivization Can Facilitate Ideal Levels of Investment."



## NATURAL HAZARD MITIGATION SAVES:

communities. Disasters clearly disrupt populations in ways that are difficult to articulate, let alone assign monetary worth.

This study updates and expands a 2005 study conducted by the National Institute of Building Sciences (Institute) Multihazard Mitigation Council (MMC), at the direction of the U.S. Congress, entitled *Natural Hazard Mitigation Saves: An Independent Study to Assess the Future Savings from Mitigation Activities* (the 2005 study), which found, among other things, that every \$1 of natural hazard mitigation funded by the Federal Emergency Management Agency (FEMA) between 1993 and 2003 saved the American people an average of \$4 in avoided future losses.<sup>2</sup>

This study provides an updated examination of the benefits of federal agency grant programs. It utilizes a more-realistic economic life span for buildings (75 versus 50 years) and takes advantage of a more advanced Hazus-MH flood model and improvements in FEMA's Benefit-Cost Analysis Tool, which, among other things, allows quantification of the benefit associated with enhanced service to the community provided by fire stations, hospitals, and other public-sector facilities. The 2005 study did not estimate the economic costs associated with PTSD. The 2005 study also did not calculate avoided insurance administrative costs, overhead, and profit, the reduction of which can add significant benefit in some situations. The ability to estimate urban search and rescue costs is introduced here.

---

<sup>2</sup> National Institute of Building Sciences. *Natural Hazard Mitigation Saves: An Independent Study to Assess the Future Savings from Mitigation Activities* (2005). [http://www.nibs.org/mmc\\_projects#nhms](http://www.nibs.org/mmc_projects#nhms)

### Mitigation Strategies Studied

The Institute's MMC undertook a study to update and expand upon the findings of its *2005 Mitigation Saves* study on the value of mitigation. The Interim Study analyzes four sets of mitigation strategies:

**Adopting I-Code Requirements:** Design based on meeting the 2018 IRC and IBC versus codes represented by 1990-era design and National Flood Insurance Program (NFIP) requirements—results in a national benefit of \$11 for every \$1 invested.

**Beyond code requirements:** The costs and benefits of designing all new construction to exceed select provisions in the 2015 IBC and the 2015 IRC and the implementation of the *2015 International Wildland-Urban Interface Code (IWUIC)*. This results in a national benefit of \$4 for every \$1 invested.

**Private-sector retrofit:** By far the dominant source of natural-hazard risk today is the existing building stock of older buildings that predate modern codes. Performing some of the most common or practical retrofit measures on the existing residential building stock produces \$4 of national benefit for every \$1 invested.

**Infrastructure:** Case studies for utility and transportation infrastructure based on Economic Development Administration (EDA) grants and California projects result in a national benefit of \$4 for every \$1 invested.

**Federal grants:** The impacts of 23 years of federal mitigation grants provided by FEMA, EDA, and the Department of Housing and Urban Development (HUD), result in a national benefit of \$6 for every \$1 invested.

### BCRS IN GREATER DEPTH

This study examines the savings (benefit) associated with an identified level of investment (cost). The ratio of the former to the latter is the BCR, which is one of many measures that decision-makers can use to judge the desirability of an investment. Here, "cost" means the up-front construction cost and long-term maintenance costs to improve existing facilities or the additional up-front cost to build new ones better. "Benefit" refers to the present value of the reduction in future losses that mitigation provides. For the results presented in this report, a real, after-inflation, cost-of-borrowing discount rate of 2.2% is used. At higher discount rates, including those used by the Office of Management and Budget (OMB), such measures remain cost effective.<sup>3</sup>

---

<sup>3</sup> Consult Section 2.11 in the full report for an in-depth discussion on discount rates.

## NATURAL HAZARD MITIGATION SAVES:

All mitigation produces benefits, so BCR is always greater than 0; there are no negative BCRs. A BCR over 1.0 signifies that the mitigation measure has an up-front cost, but after accounting for the time value of money and inflation, the future societal losses are reduced more than they cost on average. Thus, the return on investment (ROI), calculated by subtracting 1 from the BCR, is positive at the societal level. This means that the long-term cost of ownership at the societal level is lower with the mitigation than without it. The higher the BCR, the more cost effective is the measure.

The study includes the benefits associated with avoided cases of post-traumatic stress disorder, PTSD. The project team considered the cost of mental health impacts similarly to costs related to injuries as a whole; that is, as an acceptable cost to avoid a future statistical injury, as opposed to the expense associated with a particular injury. The costs consider direct treatment costs where treatment is about 10% of the overall costs of the incidence, and the other costs include things like lost wages, lost household productivity, and pain and suffering. Because few benefit-cost analyses (BCAs) even attempt to include these costs, the additional of acceptable costs to avoid a statistical instance of PTSD is a conservative but innovative addition to the 2005 *Mitigation Saves* study.<sup>4</sup>

---

<sup>4</sup> See Sections 3.10 and 4.18 of the Technical Documentation for an in-depth discussion on the calculation of PTSD.

## Why Five BCRs?

This report features five high-level BCRs representing the benefits of mitigation achievable through exceeding code provisions, meeting the latest editions of commonly adopted code requirements, select utility and transportation infrastructure mitigation strategies, and federal grant programs. While the project team recognized the desire to have a single BCR that would facilitate widespread dissemination of the project results, providing such an aggregate number will be more useful when other leading mitigation measures are considered, especially retrofit of commercial buildings, business continuity planning and disaster recovery, and direct mitigation activities by federal agencies.

The 2005 study produced the widely cited results that showed a \$4 benefit for every \$1 invested in mitigation. Despite the specific guidance that the result represented only a single, very narrow set of mitigation strategies, specifically those funded through FEMA mitigation grants, the BCR has been used to justify all types of mitigation strategies.

This report includes the results from the examination of a new set of mitigation measures: exceeding the 2015 IBC and IRC and implementing the 2015 IWUIC that provides an aggregate BCR of 4:1; meeting the 2018 IRC and IBC that provides an aggregate BCR of 11:1; private-sector retrofit of residential buildings that produces an aggregate BCR of 4:1; and utility and transportation infrastructure case studies that provide an aggregate benefit of 4:1. While these mitigation measures are an important addition to the dialogue around mitigation, they still only represent a subset of many practical strategies.

This report also provides an updated examination of the benefits of federal agency grant programs (including the addition of EDA and HUD grants), resulting in a \$6 benefit for every \$1 invested. While not a direct replacement, when used to describe federal grant programs, the 6:1 BCR can be used in place of the original 4:1.

In lieu of providing a result based on a limited set of mitigation measures, with the result likely to change as new mitigation strategies are studied and added to the aggregate number, the project team elected to provide BCRs for each strategy individually. Once the project team has identified BCRs for a sufficient number of mitigation strategies, it will provide an aggregated number representing the overall benefit of mitigation.

Figure 1 shows the overall ratio of costs to benefits for adopting the 2018 IRC and IBC as compared to 1990 design. Figure 2 shows the overall ratio of benefits to costs of designing new buildings to exceed the select 2015 I-Code requirements that the project team studied and meeting the 2015 IWUIC. The costs reflect only the added cost relative to the 2015 IBC and IRC, or the adoption of the 2015 IWUIC. Where communities have an older code or no code in place, additional costs and benefits will accrue. Figure 3 shows the overall benefit-cost ratio of the leading private-sector residential retrofit measures considered here. Figure 4 shows the overall ratio of costs to benefits for implementing select utility and transportation

## NATURAL HAZARD MITIGATION SAVES:

infrastructure mitigation strategies. Figure 5 shows the overall ratio of costs to benefits for identified federal agency mitigation programs.

Figures 1, 2, 3 and 4 show that benefits extend beyond the property lines of the mitigated buildings and the lives of occupants. Mitigation frees up resources that would otherwise be spent on insurance claims and administrative fees. Mitigation helps to assure critical post-disaster services to the community (e.g., fire stations and hospitals). Benefits and costs are rounded to no more than two significant figures to reduce the appearance of excessive accuracy.

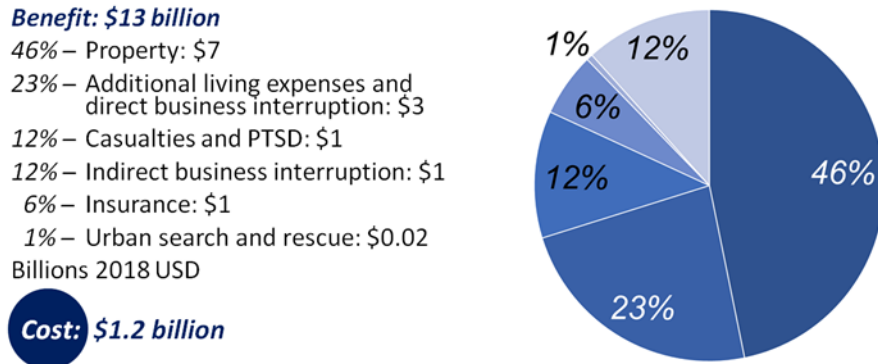

Figure 1: Total costs and benefits of meeting the 2018 IRC and IBC.

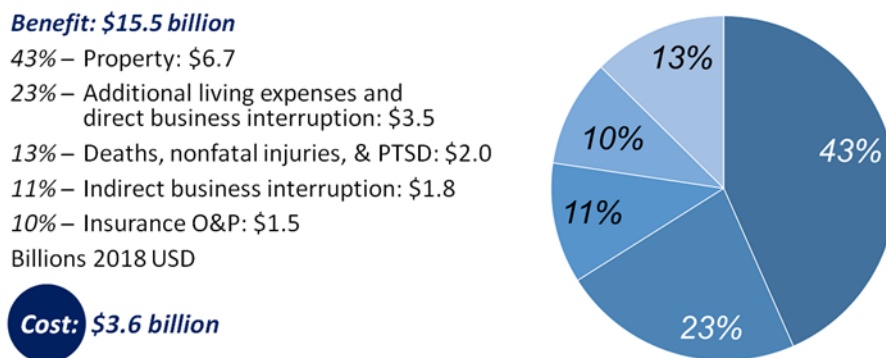

Figure 2: Total costs and benefits of new design to exceed select 2015 I-Code requirements and meet the 2015 IWUIC.

## NATURAL HAZARD MITIGATION SAVES:

### **Benefit: \$2,200 billion**

75% – Property: \$1,650  
 12% – Additional living expenses: \$270  
 6% – Indirect business interruption: \$130  
 1% – Insurance overhead & profit: \$20  
 6% – Deaths, injuries, & PTSD: \$130  
 Billions 2018 USD

**Cost: \$520 million**

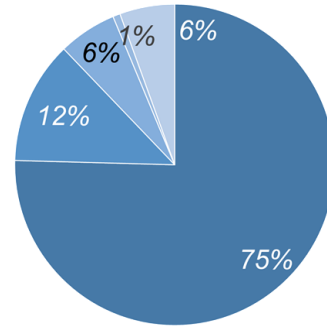

Figure 3: Total costs and benefits resulting from leading private-sector residential retrofit measures.

### **Benefit: \$2,500 million**

8% – Property: \$200  
 13% – Additional living expenses and direct business interruption: \$320  
 38% – Indirect business interruption: \$950  
 39% – Casualties & PTSD: \$980  
 2% – Environment: \$50  
 Millions 2018 USD

**Cost: \$590 million**

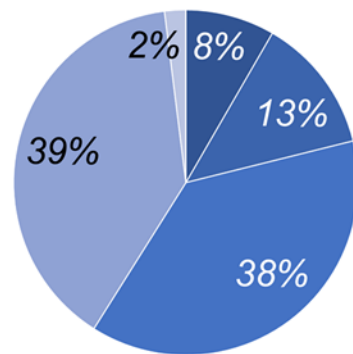

Figure 4: Total costs and benefits resulting from select utility and transportation lifeline mitigation efforts.

### **Benefit: \$157.9 billion**

43% – Casualties & PTSD: \$68.1  
 37% – Property: \$58.1  
 8% – Additional living expenses & direct business interruption: \$12.9  
 7% – Insurance: \$10.5  
 4% – Indirect business interruption: \$6.3  
 1% – Loss of service: \$2.0  
 billions 2016 USD

**Cost: \$27.4 billion**

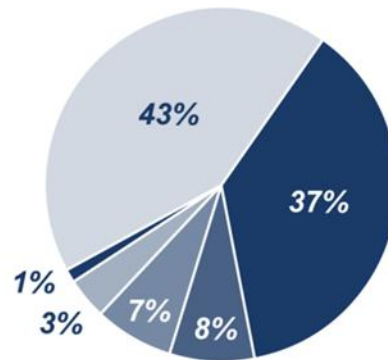

Figure 5: Total costs and benefits of 23 years of federal mitigation grants.

Table 2, Table 3 and Table 4 provide details on the costs and benefits. The costs would be experienced mostly at the time of construction.

## NATURAL HAZARD MITIGATION SAVES:

**Table 2:** Costs and benefits associated with constructing new buildings in one year to exceed select 2015 I-Code requirements or adopt the 2015 IWUIC (in \$ billions).

Mitigation Category	Cost	Benefit	BCR
Riverine Flood	\$0.91	\$4.30	<b>5:1</b>
Hurricane Surge	\$0.01	\$0.07	<b>7:1</b>
Hurricane Wind	\$0.72	\$3.80	<b>5:1</b>
Earthquake	\$1.16	\$4.30	<b>4:1</b>
Wildland-Urban Interface Fire	\$0.80	\$3.03	<b>4:1</b>
<b>Total for select measures to exceed code requirements</b>	<b>\$3.60</b>	<b>\$15.50</b>	<b>4:1</b>

**Table 3:** Costs and benefits associated with constructing new buildings to meet the 2018 IRC and IBC (in \$ billions).

Mitigation Category	Cost	Benefit	BCR
Riverine Flood	\$0.09	\$0.55	<b>6:1</b>
Hurricane Wind	\$0.53	\$5.55	<b>10:1</b>
Earthquake	\$0.58	\$6.90	<b>12:1</b>
<b>Total for adopting 2018 I-Codes</b>	<b>\$1.20</b>	<b>\$13.00</b>	<b>11:1</b>

Table 4: Costs and benefits associated with 23 years of federal grants (in \$ billions).

Mitigation Category	Cost	Benefit	BCR
Riverine Flood	\$11.54	\$82.00	<b>7:1</b>
Wind	\$13.60	\$70.00	<b>5:1</b>
Earthquake	\$2.20	\$5.73	<b>3:1</b>
Wildland-Urban Interface Fire	\$0.06	\$0.17	<b>3:1</b>
<b>Total for federal grants</b>	<b>\$27.40</b>	<b>\$157.90</b>	<b>6:1</b>

## MITIGATION BENEFITS AT THE STATE AND LOCAL LEVEL

Just as the vulnerability to specific natural hazards varies geographically, so too does the BCR for specific mitigation measures to resist those natural hazards. Figure 6 through Figure 11 identify the state- or county-specific BCRs for designing to exceed select 2015 I-Code requirements, meeting the 2015 IWUIC, and meeting the 2018 IRC and IBC. See the chapter 2 of the study report for BCR maps of the 15 private-sector building retrofit measures.

Considering the past 23 years of federally-funded mitigation grants, every state in the contiguous United States is estimated to realize at least \$10 million in benefits, with the majority of states exceeding \$1 billion in benefits. Four states: Louisiana, New Jersey, New York, and Texas, will save at least \$10 billion (See Figure 12).



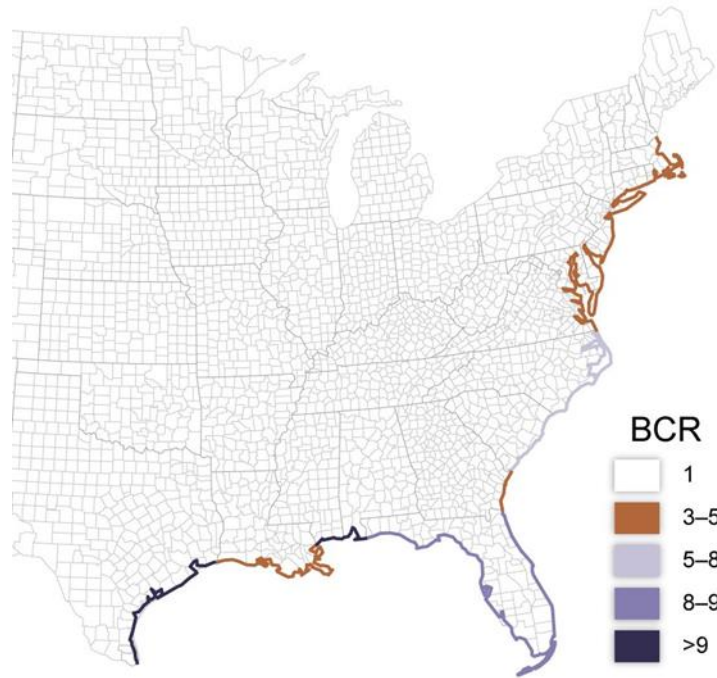

Figure 6: BCR of coastal flooding mitigation by elevating new homes above 2015 IRC requirements (by state).

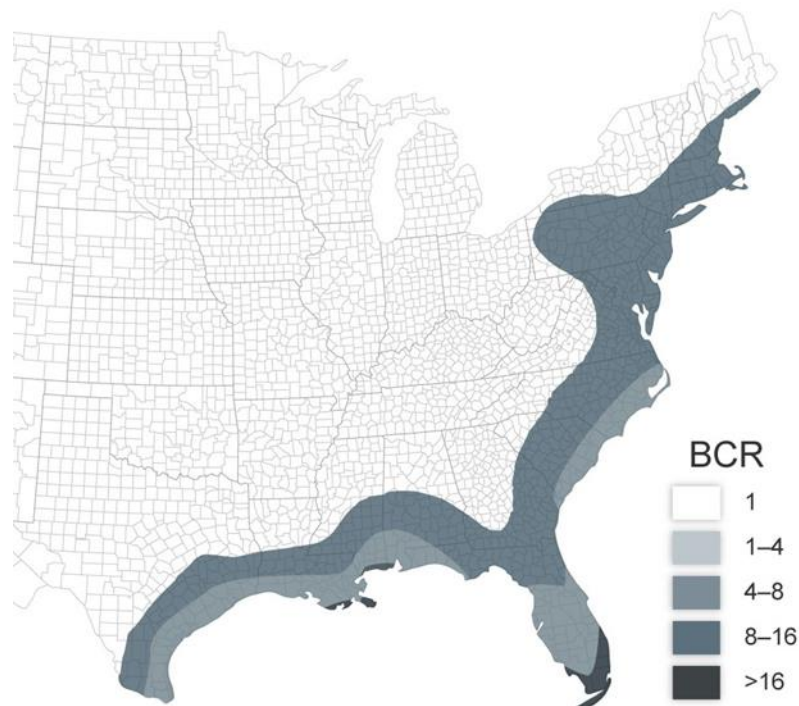

Figure 7: BCR of hurricane wind mitigation by building new homes under the FORTIFIED Home Hurricane Program above 2015 IRC requirements (by wind band).

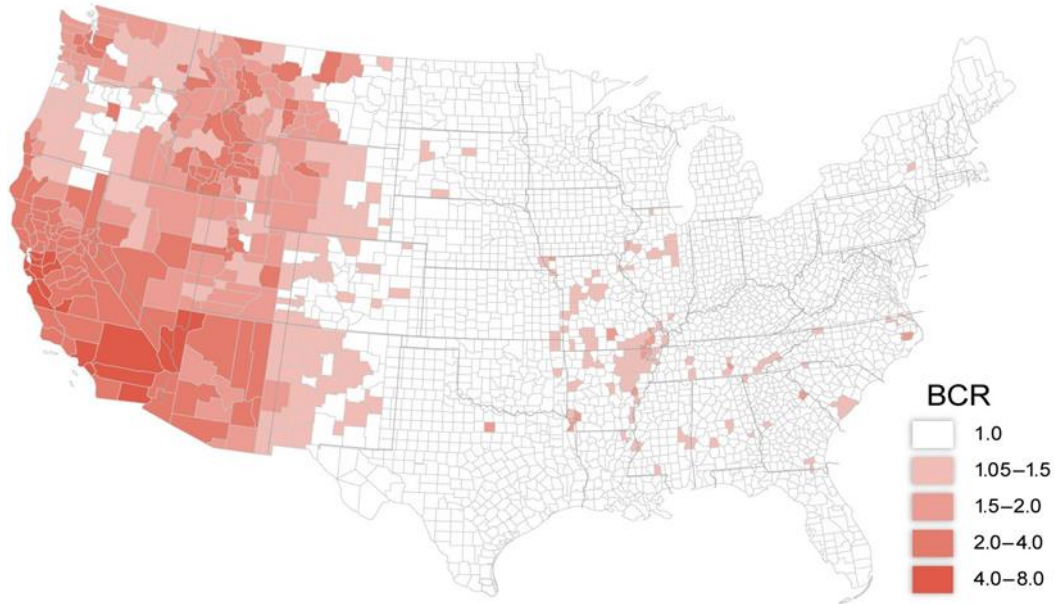

Figure 8: BCR of earthquake mitigation by increasing strength and stiffness in new buildings above the 2015 IRC and IBC requirements (by county).

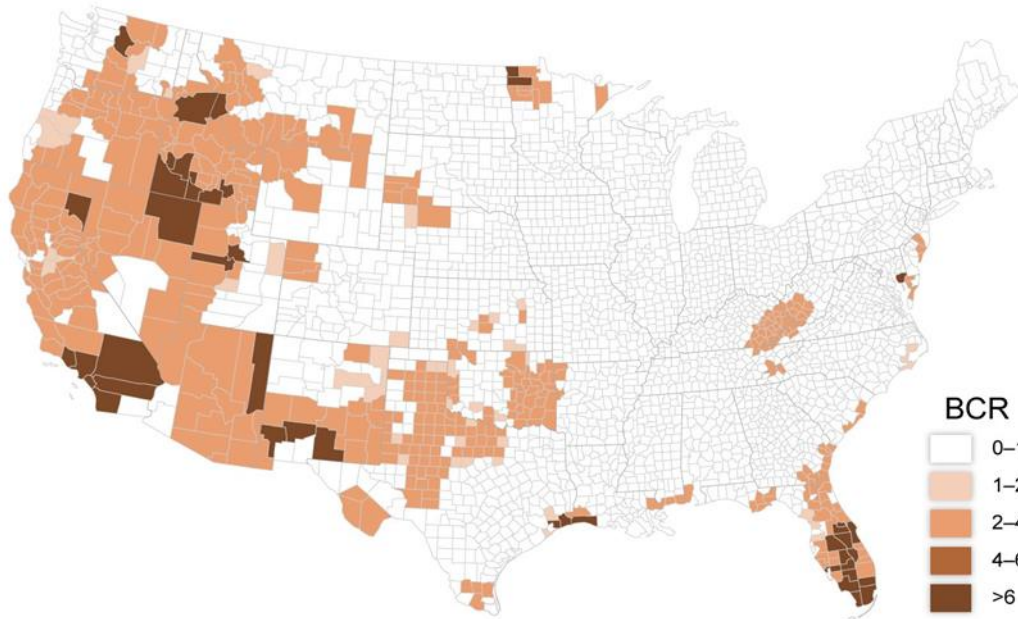

Figure 9: BCR of WUI fire mitigation by implementing the 2015 IWUIC for new buildings (by county).

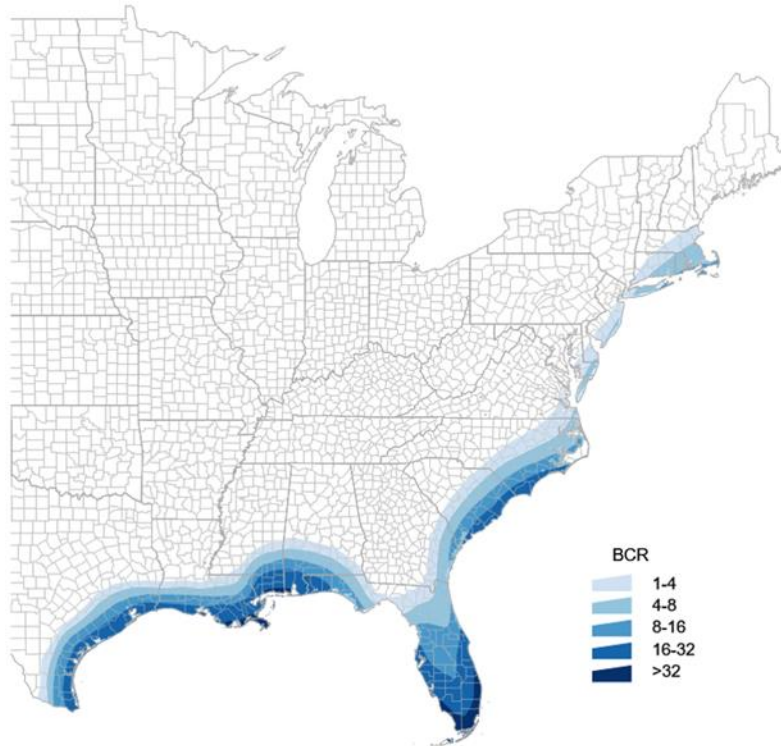

Figure 10: BCR of hurricane wind mitigation by increasing roof strength in new buildings to meet the 2018 IRC and IBC (by wind band).

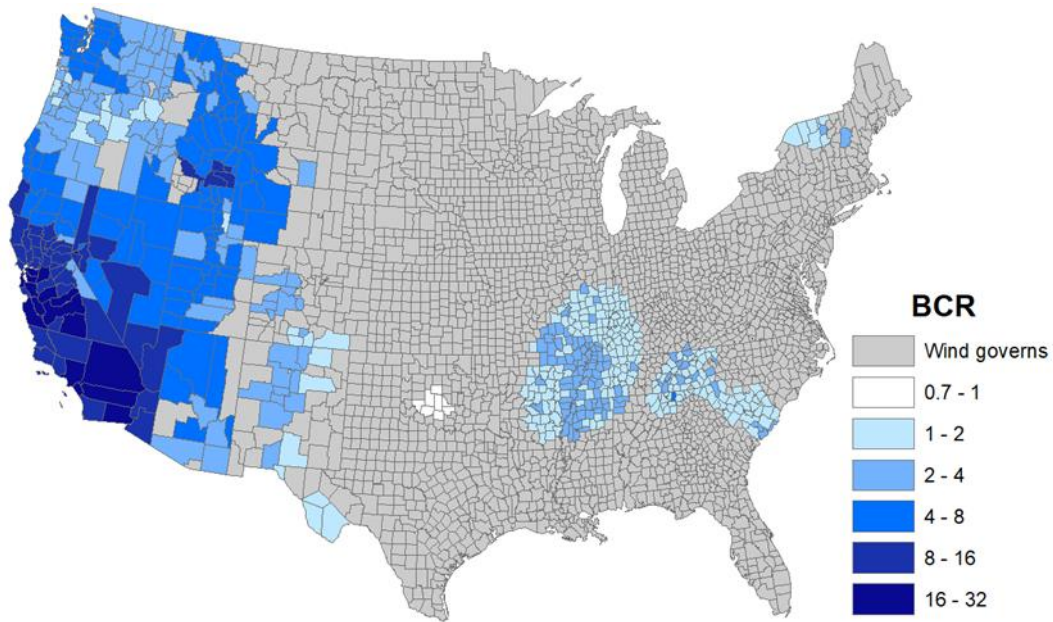

Figure 11: BCR of earthquake mitigation by increasing strength and stiffness in new buildings (by county) to meet the 2018 IRC and IBC.

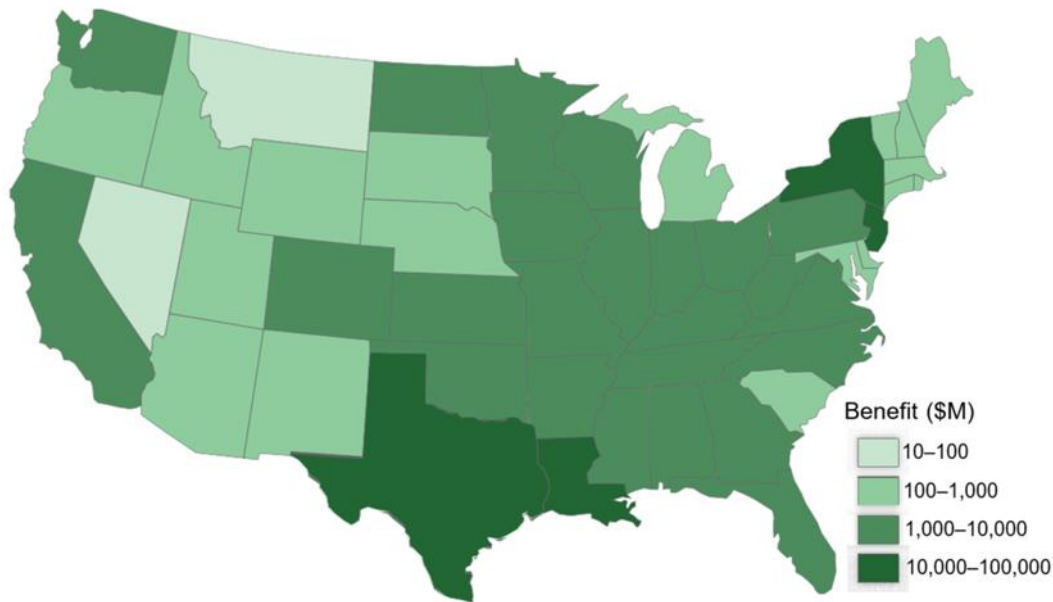

Figure 12: Aggregate benefit by state from federal grants for flood, wind, earthquake, and fire mitigation.

## BUILDING ON THE 2005 MITIGATION SAVES STUDY

In recent years, with the growing interest in the concept of resilience and the rising costs of disaster recovery, the MMC and industry stakeholders contemplated updating and expanding the 2005 study to address hazard-mitigation investments made by additional federal agencies, examine fire at the WUI, and examine mitigation measures undertaken by the private sector.

In 2017, the Institute, through a team of researchers, began a new, multi-year effort to develop an updated and expanded look at the benefits of hazard mitigation. This *2019 Report* includes the results from the study of four sets of mitigation measures. This *Summary of Findings* is the third edition of multiple documents that will ultimately examine the value of many kinds of natural hazard mitigation at the national level. The mitigation measures discussed are described in detail in the *Technical Documentation*.

## MITIGATION MEASURES STUDIED

The Study uses the same independent, transparent, peer-reviewed methods from the 2005 study. Where practical, the study advances the prior work utilizing newer or more effective techniques.

### What Benefits are Counted?

The report quantifies a number of benefits from mitigation, including reductions in:

- Deaths, nonfatal injuries, and post-traumatic stress disorder.
- Property repair costs for damaged buildings and contents.
- Additional living expenses: sheltering costs for displaced households.
- Direct business interruption: loss of revenue and other business-interruption costs to businesses whose property is damaged.
- Indirect business interruption: loss of economic activity in the broader community.
- Loss of service to the community when fire stations, hospitals, and other public buildings are damaged.
- Insurance overhead and profit costs other than insurance claim payments.
- Urban search and rescue costs.
- Environmental losses in limited cases.

The project team considered the benefits that would result if all new buildings built in one year were designed to exceed select I-Code requirements where it is cost effective to do so. If accomplished, the benefits would be that much greater in proportion to this quantity of new buildings. The stringency of codes adopted at the state and local level varies widely. To set a consistent starting point, the project team used the 2015 IRC and IBC as the baseline minimum codes. While minimum codes provide a significant level of safety, society can save more by designing some new buildings to exceed minimum requirements of the 2015 IRC and IBC and to comply with the 2015 IWUIC in others. Strategies to exceed minimum requirements of the 2015 I-Codes studied here include:

- For flood resistance (to address riverine flooding and hurricane surge), build new homes higher than required by the 2015 IBC.
- For resistance to hurricane winds, build new homes to comply with the Insurance Institute for Business & Home Safety (IBHS) FORTIFIED Hurricane standards.
- For resistance to earthquakes, build new buildings stronger and stiffer than required by the 2015 IBC.
- For fire resistance in the WUI, build new buildings to comply with the 2015 IWUIC.

The project team also considered the benefits that would result if all new buildings built in one year were designed to meet 2018 IRC and IBC versus codes represented by 1990 design and NFIP requirements. Across the country, code adoption is not uniform—the code editions in place vary widely from jurisdiction to jurisdiction. Some jurisdictions adopt new editions on a regular cycle, while others remain on older editions. With each new edition, additional benefits accrue. Some jurisdictions may capture these benefits in incremental pieces with each adoption, while others update their codes less frequently, during which time the benefits from more recent codes are not realized. Code-based mitigation strategies include:

- For flood resistance, incorporate at least one foot of freeboard into the elevation requirements to comply with the 2018 I-Codes.

## NATURAL HAZARD MITIGATION SAVES:

- For resistance to hurricane winds, build new roofs to comply with the 2018 I-Codes and comply with a variety of openings and connection detailing requirements added since 1990.
- For resistance to earthquakes, build new buildings stronger and stiffer relative to 1990 construction to comply with the 2018 I-Codes.

The project team evaluated the costs and benefits of 15 retrofit measures for existing (mostly residential) buildings:

### Flood retrofit

1. Acquisition and removal of buildings from the floodplain, often called buyouts
2. Elevation of existing buildings
3. Wet floodproof basements
4. Elevation of air conditioning equipment and ductwork
5. Elevation of water heaters and furnaces

### Hurricane retrofit

6. Retrofit to comply with IBHS FORTIFIED Home Hurricane
7. Add engineered tie-down system to manufactured homes

### Earthquake retrofit

8. Add steel frame and structural sheathing to soft-story wood-frame apartment building
9. Add engineered tie-down system to manufactured homes
10. Secure water heaters to the building frame
11. Add child safety latches to kitchen cabinet doors
12. Secure tall bookcases to the building frame
13. Strap freestanding monitors and televisions to shelves
14. Secure fragile items to shelves with museum putty

### Retrofit buildings in the wildland-urban interface

15. Retrofit buildings to comply with the International Wildland-Urban Interface Code

The project team used 12 EDA grants and additional mitigation measures as case studies to show the degree to which mitigation of utilities and transportation lifelines can be cost effective. The project team estimated BCRs for several categories of infrastructure: water, wastewater, electricity, telecommunications, roads, and railroads. The measures studied include:

- Elevating roads and railroads; elevating water treatment plant electrical equipment; and relocating to higher ground electrical substations, telephone substations, water treatment plants, and wastewater treatment plants to better resist flood.
- Protecting water and wastewater treatment plants with berms.
- Moving electrical transmission lines underground to better resist wind loads.

## NATURAL HAZARD MITIGATION SAVES:

- Strengthening bridge structures to better resist earthquake forces.
- Strengthening substation buildings and equipment to create a more earthquake-resilient electric grid.
- Hardening selected water pipelines to create a more earthquake-resilient water-supply grid.

The federal agency strategies consider 23 years of public-sector mitigation of buildings funded through FEMA programs, including the Flood Mitigation Assistance Grant Program (FMA), Hazard Mitigation Grant Program (HMGP), Public Assistance Program (PA), and Pre-Disaster Mitigation Grant Program (PDM), as well as the HUD Community Development Block Grant Program (CDBG) and several programs of the EDA. Barring identification of additional federal data sets or sources of federal mitigation grant and loan funding, these analyses represent essentially a comprehensive picture of such mitigation measures. In the future, the project team might also look at mitigation measures directly implemented by federal agencies.<sup>5</sup> Results represent an enhanced and updated analysis of the mitigation measures covered in the 2005 study. Public-sector mitigation strategies based on federal grants include:

- For flood resistance, acquire or demolish flood-prone buildings, especially single-family homes, manufactured homes, and 2- to 4-family dwellings.
- For wind resistance, add hurricane shutters, tornado safe rooms, and other common measures.
- For earthquake resistance, strengthen various structural and nonstructural components.
- For fire resistance, replace roofs, manage vegetation to reduce fuels, and replace wooden water tanks.

## MULTIPLE STAKEHOLDERS BENEFIT FROM ADOPTING OR EXCEEDING I-CODE REQUIREMENTS

Designing new buildings to exceed select 2015 IBC and IRC requirements (where it is cost effective to do so) for flood, hurricane wind and earthquake; designing new buildings in parts of the WUI to meet the 2015 IWUIC to better resist fire; and meeting the 2018 I-Code requirements for flood, hurricane wind and earthquake affect various stakeholder groups differently. The project team considered how each of five stakeholder groups bears the costs and enjoys the benefits of mitigation for the natural hazards under consideration. Stakeholders include:

- Developers: Corporations that invest in and build new buildings, and usually sell the new buildings once they are completed, owning them only for months or a few years.
- Title holders: People or corporations, who own existing buildings, generally buying them from developers or from prior owners.
- Lenders: People or corporations that lend a title holder the money to buy a building. Loans are typically secured by the property, meaning that if the title holder defaults on loan payments, the lender can take ownership.

---

<sup>5</sup> Such measures include U.S. Army Corp of Engineers levees and other water management programs; National Oceanic and Atmospheric Administration early warning systems for weather; and U.S. Department of Agriculture (USDA) Forest Service prescribed burns.

## NATURAL HAZARD MITIGATION SAVES:

- Tenants: People or corporations who occupy the building, whether they own it or not. This study uses the term “tenant” loosely, and includes visitors.
- Community: People, corporations, local government, emergency service providers, and everyone else associated with the building or who does business with the tenants.

When one subtracts the costs each group bears from the benefits it enjoys, the difference—called the net benefit—is positive in each category. Figure 13 and Figure 14 reflect long-term averages to broad groups, so it only speaks to the group as a whole, on average, rather than to the experience of each individual member of the group.

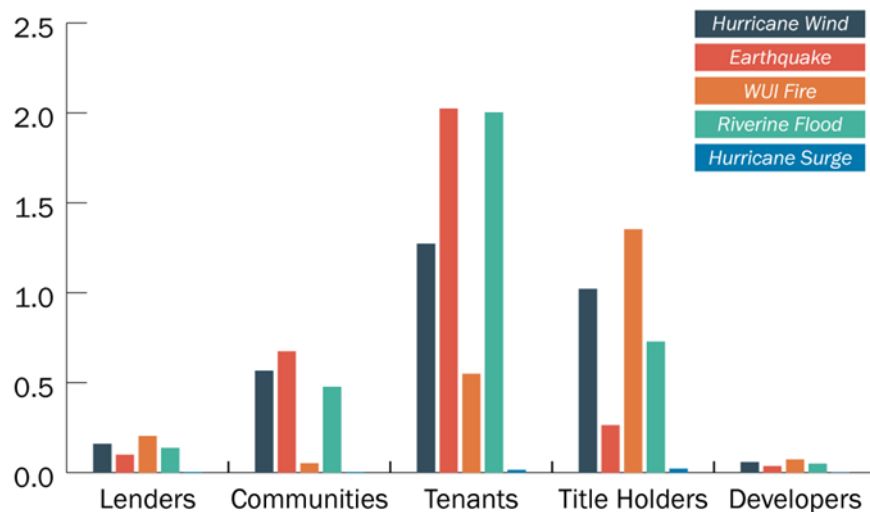

**Figure 13:** Stakeholder net benefits resulting from one year of constructing all new buildings to exceed select 2015 IBC and IRC requirements or to comply with 2015 IWUIC.



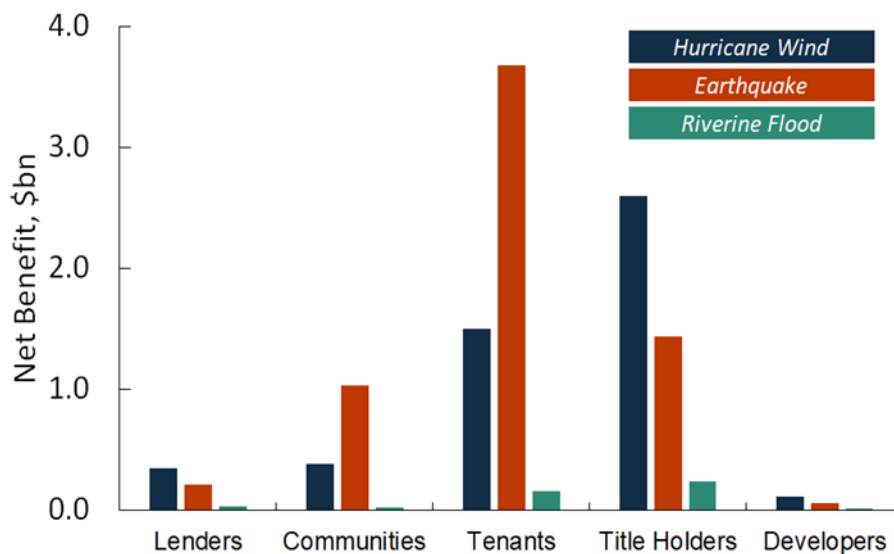

Figure 14: Stakeholder net benefits per year of new construction resulting from meeting the 2018 IRC and IBC.

## ADDITIONAL MITIGATION MEASURES

The project team analyzed a number of mitigation measures, but they do not represent all of the measures that could ultimately be applied to address the natural hazards studied. Recognizing the current limited applicability of the data provided here, the project team identified additional mitigation measures but their analysis remains unfunded, such as retrofit of commercial private-sector buildings, business continuity planning and disaster recovery, and direct mitigation action by government entities.

## BENEFITS ACCRUE ACROSS A SPECTRUM OF DESIGN OPTIONS

The selected options to exceed 2015 I-Code requirements for flood, wind, and earthquake offer a range of design levels. The project team, as an example, analyzed these ranges, which include different elevations above base flood elevation (BFE), different IBHS FORTIFIED Home Hurricane design levels (Silver, Bronze, and Gold), and different strength and stiffness factor  $I_e$  for seismic design. The project team identified the point on a geographic and mathematical basis where the last incremental improvement in the design cost effectively captures the last incremental benefit, here called the incrementally efficient maximum or IEMax.

In all cases, significant benefits can be achieved cost effectively at various levels of design up to this identified point, meaning that one can enjoy cost-effective improvement without designing all the way up to the IEMax. The ideal level of mitigation for a specific project will vary. The benefits and costs of mitigation measures at the project level should be evaluated based on the specific characteristics of the

## NATURAL HAZARD MITIGATION SAVES:

project and the needs of the owner and users. This study does not address project-level conditions or the decision-making required at an individual project level.

Table 5 provides BCRs at the state level that correspond to a range of elevations above BFE. Figure 15 and Figure 16 illustrate where the two IBHS FORTIFIED Home Hurricane and High Wind programs and the range of earthquake strength and stiffness factors result in cost-effective design.

**Table 5:** BCRs for various heights above BFE for new coastal V-zone buildings.

State	First Floor Height above BFE up to IEMax	BCR
Texas	+2 to 8	<b>20.2 to 9.1</b>
Louisiana	+2 to 10	<b>11.3 to 4.8</b>
Mississippi	+2 to 10	<b>27.6 to 10.1</b>
Alabama	+2 to 10	<b>31.1 to 11.7</b>
Florida	+2 to 10	<b>21.1 to 8.4</b>
Georgia	+2 to 6	<b>6.7 to 3.8</b>
South Carolina	+2 to 10	<b>11.8 to 5.0</b>
North Carolina	+2 to 10	<b>12.6 to 5.2</b>
Virginia	+2 to 6	<b>6.7 to 3.8</b>
Delaware	+2 to 6	<b>6.7 to 3.8</b>
Maryland	+2 to 6	<b>6.7 to 3.8</b>
New Jersey	+2 to 6	<b>6.7 to 3.8</b>
New York	+2 to 6	<b>6.7 to 3.8</b>
Connecticut	+2 to 6	<b>6.7 to 3.8</b>
Rhode Island	+2 to 6	<b>6.7 to 3.8</b>
Massachusetts	+2 to 6	<b>6.9 to 3.9</b>
<b>Total</b>		<b>16.9 to 7</b>

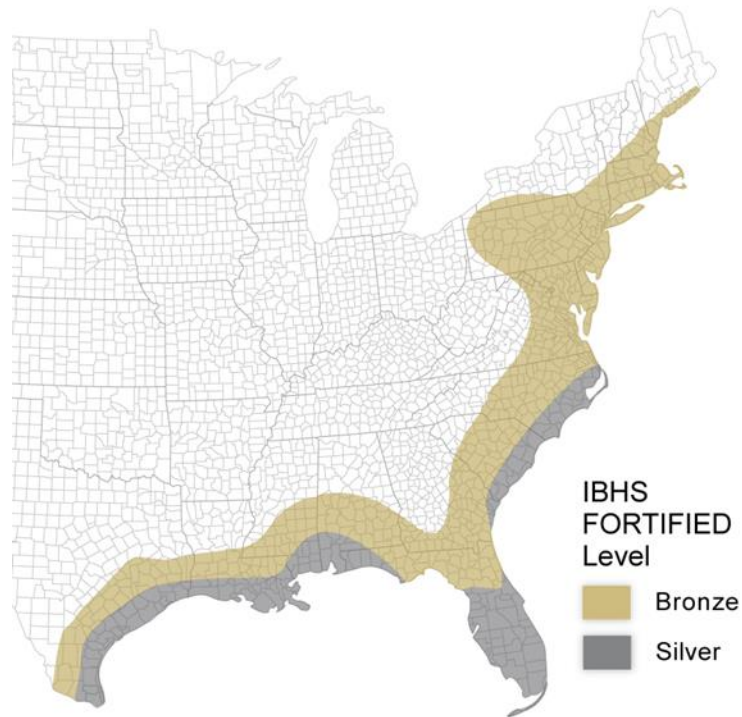

Figure 15: Maximum level of the IBHS FORTIFIED Home Hurricane design for new construction where the incremental benefit remains cost effective.

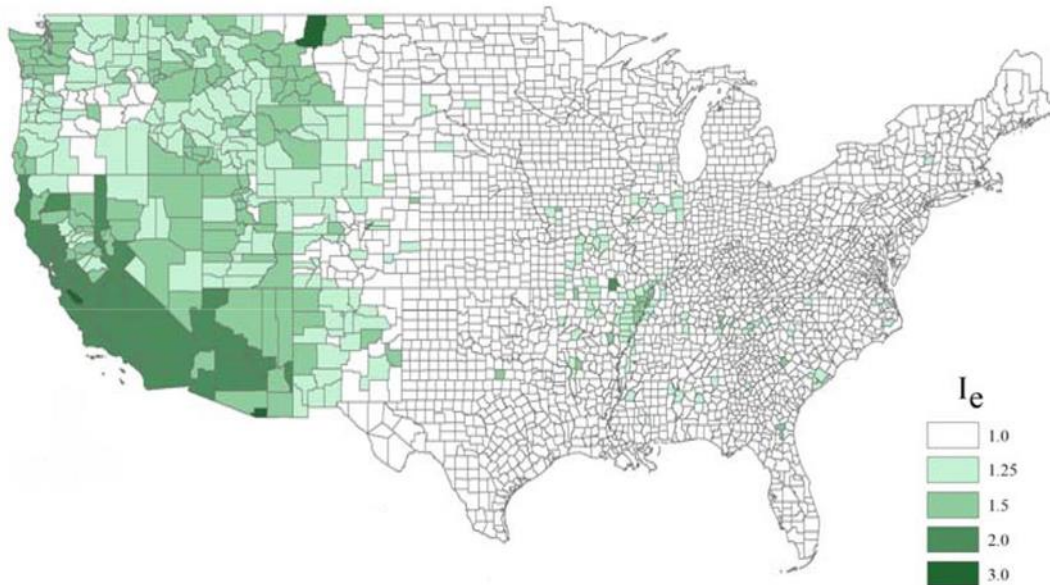

Figure 16: Maximum strength and stiffness factor  $I_e$  to exceed 2015 IBC and IRC seismic design requirements where the incremental benefit remains cost effective.

### UTILIZING THE BEST AVAILABLE SCIENCE

To provide meaningful results within a reasonable timeframe and budget, the project team identified and used the best available, yet practical, science. For example, to estimate how earthquakes damage buildings, the project team used a 20-year-old method of structural analysis. Despite the existence of newer tools, this older approach was the only practical way to proceed given the enormous variety of building types, heights, occupancy classes, and design requirements that exist in the built environment.

Focusing on single mitigation strategies provides a means for understanding mitigation options, but does not capture the nuances of individual buildings and the hazards they may face. The report examines the overall average cost effectiveness of mitigating broad classes of buildings, but does not address unique features of individual buildings. The details of a particular building can make a big difference in the cost effectiveness of mitigation. Elevating buildings reduces the chance that they will be flooded; however, people can still be stranded in elevated buildings. Designing new buildings to be stronger and stiffer in resisting earthquake loads reduces structural damage, but can increase the damage to acceleration-sensitive components such as furniture and other contents, unless one also takes care to properly install or secure those components, such as by strapping tall furniture to the building frame. Furthermore, using a simple factor for greater strength and stiffness may cost more or save less than a design that uses base isolation or another design technique, or it may be more cost effective and more practical than using more sophisticated but less appropriate mitigation measures. It is probably far simpler, more practical, and more cost effective to add more steel or concrete to a strip mall than to base isolate it or fine-tune the structural design. Each approach has its advantages and disadvantages, conditions under which it works better or not as well as competing alternatives.

Mitigation decisions take place in contexts that involve more than tangible costs and benefits. Other decision-maker preferences; available financial resources; legal and time constraints; justice and equity; and other variables also matter. The project team did not examine these other considerations, which could matter more than BCR. Furthermore, this study offers BCR estimates as one consideration for a wide variety of possibly complex decision situations that community leaders often face.

### INCENTIVIZATION CAN FACILITATE IDEAL LEVELS OF INVESTMENT

Not everyone is willing or able to bear the up-front construction costs for more resilient buildings, even if the long-term benefits exceed the up-front costs. Different stakeholders enjoy different parts of the costs and benefits, and the people who bear more of the costs may argue more urgently against mitigation than the people who enjoy more of the benefits. However, one set of stakeholders may be able to offer incentives to others to decrease the cost or increase the benefit, and better align the competing interests of different groups. The MMC and the Institute's Council on Finance, Insurance and Real Estate (CFIRE) have proposed a holistic approach to incentives that can drive coordinated mitigation investments,

## NATURAL HAZARD MITIGATION SAVES:

aligning the interests of multiple stakeholder groups so that they all benefit from a cooperative approach to natural hazard mitigation.<sup>6</sup>

### RESULTS INFORM MITIGATION DECISION-MAKING

This *Summary of Findings* and the study report add to the growing body of scientific evidence that demonstrates that mitigation lessens the financial impact of disasters on local businesses, communities, taxpayers, and governments, and thus enables individuals and communities to recover more rapidly from these events when they do occur. Additionally, it affirms that decision-makers, including governments, building owners, developers, tenants, and others, should consider opportunities for implementing mitigation activities to reduce the threat to lives, homes, businesses, schools, and communities, while also reducing future repair and rebuilding costs.

### EXPERT CONTRIBUTIONS TO THE INTERIM STUDY

NIBS's project team, which consisted of five leaders (the principal investigator and four co-principal investigators) and eight co-authors, developed the methodology with oversight by four committees, with a combined membership of 24 independent experts, who peer-reviewed the work and confirmed the results. Institute staff directed and managed the overall effort. FEMA provided additional review by 20 subject matter experts. Other agencies of the federal government, including EDA, HUD, and OMB, contributed a total of nine experts who provided input in developing the project, its methods, data, and products, or reviewed the study for reasonableness and usefulness. In particular, HUD, along with FEMA, provided economic input to the benefit-cost methodology. Four experts from ICC conducted several reviews. A total of 43 other representatives from 32 other organizations and stakeholder groups, including banking, insurance, government, construction, natural hazards, economic policy, environmental science, and structural engineering, provided oversight and peer review. The project team is well-known for expertise in earthquake engineering, fire, flood, and wind risk, as well as engineering economics and disaster sociology. Several of the authors participated in or helped lead the 2005 study. In total, the Interim Study represents the combined effort of over 100 experts in virtually all fields relevant to natural hazard mitigation in the United States.

### FEDERAL- AND PRIVATE-SECTOR SUPPORT FOR THE INTERIM STUDY

A number of public- and private-sector organizations interested in expanding the understanding of the benefits of hazard mitigation generously funded the research presented here, as well as the project team's ongoing work. Funders to date are Premier Plus Sponsor FEMA; Premier Sponsors EDA and HUD; Lead Sponsor ICC; Sponsors IBHS and National Fire Protection Agency; and Supporter American Institute of

---

<sup>6</sup> National Institute of Building Sciences, *Developing Pre-Disaster Resilience Based on Public and Private Incentivization* (2015). [http://www.nibs.org/resource/resmgr/MMC/MMC\\_ResilienceIncentivesWP.pdf](http://www.nibs.org/resource/resmgr/MMC/MMC_ResilienceIncentivesWP.pdf)

## **NATURAL HAZARD MITIGATION SAVES:**

Architects. While representatives from these organizations provided data and expertise to the project team, their input was largely informative, resulting in a truly independent study. The Institute seeks additional funders to support the study of additional mitigation measures.

# Technical Documentation

# 1. Introduction

## 1.1. BACKGROUND

Hurricanes, tornadoes, floods, earthquakes, and wildfires are inevitable. Because of a variety of factors, the impacts of these events are expected to increase—particularly during the useful life of much existing and most new U.S. infrastructure. These environmental stresses will damage property, injure, and kill people, threaten the viability of entire communities, and severely impact the U.S. economy. Increased density and complexity of the urban environment also increase the likelihood of larger, more costly disasters. Society will certainly bear the costs to respond to such events.

Fortunately, there are measures governments, building owners, developers, tenants, and others can take to reduce the impacts of hazard events. These measures—called mitigation—can result in significant savings in terms of safety, and prevention of property loss, and disruption of day-to-day life. Data should inform decision-making around the level and timing of mitigation investments. Important data include the increase in safety, decreased economic impact and human misery, jobs saved or created, and the speed of business activity recovery associated with a particular level of investment.

The National Institute of Building Sciences (Institute), through its Multihazard Mitigation Council (MMC), works to advance the utilization of cost-effective solutions to reduce the impacts of hazards. In 2005, the Institute published the results of a study, *Natural Hazard Mitigation Saves: An Independent Study to Assess the Future Savings from Mitigation Activities*, which examined the benefits of investments by the Federal Emergency Management Agency (FEMA) in disaster mitigation (Multihazard Mitigation Council 2005). The results presented in this Interim Study, which is an update and expansion of the 2005 study, attempt to answer questions that inform mitigation and present the first broad set of hazards and mitigation measures. The project team will evaluate additional mitigation measures and provide BCRs on such measures once available.

The Summary of Findings is accessible to the general public and policymakers, while the Technical Documentation presents a detailed technical analysis of these questions. The Technical Documentation speaks specifically to specialists: scientists, engineers, architects, and social scientists who want to understand the Interim Study's objectives, mathematical methods, and findings in great detail. Appendix L provides a series of stand-alone documents that will be useful in communicating Interim Study results to a widespread audience of policymakers, businesspeople, and homeowners who make decisions on how to implement natural hazard mitigation strategies.

Both volumes seek to provide insight to those who will make hazard-mitigation investments based on the benefit-cost ratio (BCR) of their investment by answering the following questions:

- What is the overall average BCR for U.S. natural hazard mitigation efforts?



## NATURAL HAZARD MITIGATION SAVES:

- Under what conditions—what locations, what hazards, what particular mitigation measures, what categories of infrastructure—is the BCR higher or lower?
- Can one identify mitigation efforts not yet undertaken that would have a higher BCR, and use that information to make better investments in public and private infrastructure?

Answers to these questions can inform a variety of mitigation decisions, but they do not touch on many of the relevant variables. Mitigation decisions take place in business, political, social, and personal contexts that involve benefits and costs, but also preferences, financial resources, legal and time constraints, justice and equity, and other variables that far exceed the scope of the Interim Study. The Interim Study only considers the benefits and costs of some leading mitigation options. It does not identify or examine the local context under which mitigation decisions are made. Local, regional, and even statewide factors may influence mitigation decisions. The project team therefore makes no recommendations nor does it advocate for one mitigation option over another, or advocate for mitigation over not mitigating. The Interim Study offers benefit and cost information merely to serve as a resource in making complex mitigation decisions.

People commonly measure benefits and costs with BCRs. Other metrics besides BCR can quantify the desirability of mitigation, including the degree to which mitigation reduces total cost of ownership. Mitigation can reduce the probability of catastrophic outcomes. A business decision-maker thinking about how mitigation affects profits might use BCR to decide whether an investment is worthwhile. On the other hand, if the decision-maker thinks that a natural hazard might threaten the survival of the business, a BCR is the wrong measure to use. The decision-maker should consider losses in a rare event, e.g., such as a low-probability event with major impacts, through loss-exceedance curves or, more qualitatively, by considering outcomes in a few disaster scenarios. The Interim Study does not quantify loss-exceedance curves.

The Interim Study evaluates BCRs in large part because U.S. infrastructure investments must be “based on systematic analysis of expected benefits and costs, including both quantitative and qualitative measures” (Clinton 1994). BCR is straightforward and a commonly used metric of expected benefits and costs. The 2005 Mitigation Saves study measured the efficacy of natural hazard mitigation in terms of BCR.

The 2005 study resulted from a 1999 request by the U.S. Congress instructing FEMA to conduct an independent review of the benefits and costs of FEMA-funded natural hazard mitigation efforts. That study found, among other things that on average, FEMA-funded natural hazard mitigation saved \$4 for every \$1 spent.<sup>2</sup> The 4:1 study has subsequently been cited hundreds of times in scholarly literature, dozens of times in Congressional hearings, and many times in reports, public presentations, and elsewhere, as information to inform and support increased investment in natural hazard mitigation.

---

<sup>2</sup> The ratio was shown to vary between perils and other factors, but people tend most often to quote the overall number.

### Box 1-1. Mitigation Measures to be Examined in the *Mitigation Saves* Interim Study

- Code adoption and design to exceed International Code (I-Code) requirements. What benefit can be provided by designing new buildings to exceed the requirements of the *2015 International Building Code* (IBC) and *2015 International Residential Code* (IRC) for flood, wind, and earthquake resistance? What benefit can be provided by adopting the *2015 International Wildland-Urban Interface Code* (IWUIC)? (Complete)
- About one in seven people live in communities that have not adopted recent I-Codes (2012 or later), or in communities that have weakened their disaster-resistance requirements. Other communities have frequently updated their codes. What benefit is provided by adopting the 2018 IBC and 2018 IRC for flood, wind, and earthquake resistance? Note that the study was performed in several stages, beginning before the release of the 2018 I-Codes and continuing afterwards, so earlier parts of the study deal with earlier code editions; later parts, later editions. (Complete)
- Private-sector retrofit of existing facilities. FEMA guidelines and other common practices remediate deficiencies of existing facilities' resistance to various natural hazards. What are some leading options and how cost-effective are they? (Complete)
- Business continuity planning (BCP) and disaster recovery (DR). How cost-effective is BCP/DR in the private sector? (Future)
- Utility and transportation lifeline mitigation. What are some leading options to make utilities and transportation lifelines more disaster-resistant, and how cost-effective are they? (Complete)
- Public-sector grants to support mitigation. Since 1993, how cost-effective were natural hazard mitigation efforts undertaken with funding support from various federal agencies? (Complete)
- Public-sector direct mitigation efforts. How cost-effective were various direct mitigation actions by federal agencies? Many government agencies engage in natural hazard mitigation as part of their mission, such as the U.S. Army Corps of Engineers (USACE) flood-control efforts, the National Weather Service (NWS) work on hurricane forecasting, and the U.S. Geological Survey (USGS) efforts to develop earthquake early warning systems. (Future)

As useful as the 4:1 ratio has proven to be in communicating the BCR of mitigation, FEMA-funded mitigation represents only a fraction of all natural-hazard mitigation in the United States. Intuitively, building a new facility to be more disaster-resistant is likely to cost less than retrofitting that facility to the same level of disaster resistance after the fact. The 4:1 ratio may underestimate the benefit of other classes of natural hazard mitigation. Current building codes have already substantially advanced safety and property protection relative to prior codes.

The 2005 study focused solely on FEMA-funded mitigation activities. However, other federal agencies also perform or fund mitigation activities, such as the Economic Development Administration (EDA) and U.S. Department of Housing and Urban Development (HUD).

### 1.2. OBJECTIVES

The *2019 Report* updates and expands upon the mitigation measures studied in 2005 by evaluating a broad suite of mitigation measures that can inform decision-making around investments to reduce the impacts of natural hazards. The *2019 Report* includes the work of the team for the past two year and compiles the results from three specific strategies: the benefits and costs of new buildings designed to exceed select model building code requirements provided by the International Code Council (ICC); the benefits and costs of adopting ICC's model building codes, relative to some older code edition; and the cost effectiveness of grants by federal agencies. Box 1-1 summarizes the natural hazard mitigation topics identified for study, those covered to date, and those funded for study. See Section 1.3 for additional details on these Interim Study topics. Ongoing research will examine additional mitigation measures that will be incorporated into future reports.

The project team has studied five categories of natural hazard mitigation efforts to date:

1. **Design of typical new buildings to exceed certain requirements of the 2015 IBC and IRC, and to conform to the 2015 IWUIC** (International Code Council 2015a, b, c). Model codes represent minimum requirements, not maxima. What might be the costs and benefits of exceeding those minima? The Interim Study addresses that question by estimating the costs and benefits of exceeding code minima in a few particular ways. This is not to say there is anything wrong with current codes, which offer great improvements in performance relative to older codes. I-Codes aim largely, though not exclusively, to protect immediate life safety. For example, the intent of the 2015 National Earthquake Hazards Reduction Program (NEHRP) Recommended Seismic Provisions (Federal Emergency Management Agency 2015d), which underpins the I-Code seismic requirements, is "to provide reasonable assurance of seismic performance that will avoid serious injury and life loss ... preserve means of egress, avoid loss of function in critical facilities, and reduce structural and nonstructural repair costs where practicable." Its provisions allow for substantial damage at the levels of shaking that approach the risk-targeted maximum earthquake considered in the codes and underlying standards. Recent earthquakes have shown that buildings in the epicentral region can experience ground motion exceeding the risk-targeted maximum considered earthquake (MCER) motion. For example, in the moment magnitude (Mw) 7.0 Anchorage, Alaska Earthquake of November 30, 2018, the U.S. Geological Survey's National Strong Motion Project Station 8047 recorded a peak 5% damped spectral acceleration response at 0.17-sec period of 3.2 g and 5% damped 0.2-sec spectral acceleration response of 2.1 g. Its ASCE 7-16 mapped value SMS was 1.5 g (COSMOS Strong Motion Center 2018). Even in a relatively modest event, ground motions can exceed design values. In the Mw 6.0 South Napa Earthquake of August 24, 2014, station CE.68206 recorded a maximum-direction 5%

damped short-period spectral acceleration response of 1.32 g; its ASCE 7-16 design value SDS was 1.2g.

As leaders work to improve the resilience of their communities, the long-term, ongoing safety and operations of buildings will require consideration of measures that enhance current code minimums.

The Interim Study addresses whether it is economical to exceed life safety by reducing damage and perhaps increasing the likelihood of immediate occupancy of buildings after a natural disaster. The Interim Study examines the risk-category II buildings of the 2015 International Building Code (IBC): the homes, strip malls, office complexes, industrial buildings, and so on that comprise the vast majority of new buildings. The Interim Report does not address the less-common (though still important) buildings of risk categories I (e.g., minor storage facilities), III (e.g., auditoriums) or IV (e.g., hospitals).

- 2. Design of typical new buildings to comply with the 2018 IBC and IRC, compared with 1990-era design requirements.** For earthquake loads, 1990-era design is represented by the 1988 Uniform Building Code (UBC). For hurricane loads, 1990-era design is represented by the 1990 National Building Code and 1991 Southern Standard Building Code. For flood, 1990-era construction is represented by NFIP requirements for elevation of the first floor above base flood elevation. Building codes have long been recognized as mitigation tools. However, the benefits of their adoption have not been quantified. This study looks to quantify the benefits accrued since the establishment of modern building codes. Seismic design has continually evolved over the past century, including notable changes in the mid-1980s. Wind design likewise improved over a long period of time, including some particularly notable improvements following Hurricane Andrew in 1992. In the years since, codes have improved substantially through updates on a three-year review cycle. Flood design has been modernized from NFIP standards through the I-Codes' requirement that buildings at risk of flooding have a first floor at least 1 foot above base flood elevation (BFE). The present study therefore seeks to estimate the benefit resulting from updates in seismic and wind design since approximately 1990, and from NFIP to 2018 I-Codes for flood design.
- 3. Mitigation of existing buildings funded by FEMA, EDA, and HUD.** The federal agency strategies consider 23 years of public-sector mitigation of buildings funded through FEMA programs, including the Flood Mitigation Assistance (FMA) Grant Program, Hazard Mitigation Grant Program (HMGP), Public Assistance (PA) Program, and Pre-Disaster Mitigation (PDM) Grant Program, as well as the HUD Community Development Block Grant Program (CDBG) and several programs of the EDA. Barring identification of additional federal data sets or sources of federal mitigation grant and loan funding, these analyses represent essentially a comprehensive picture of such mitigation measures. Mitigation efforts within other federal agencies, including the U.S. Department of Transportation (DOT), and within agencies where measures are implemented directly (e.g., U.S. Army Corps of Engineers (USACE) for flood control) may be the subject of future study. Some of the mitigation work funded by grants from these agencies may have used criteria from the IBC and International

## NATURAL HAZARD MITIGATION SAVES:

Residential Code (IRC), but also the International Existing Building Code (IEBC) and additional criteria such as that identified in Chapter 2.<sup>8</sup> (2015d and older editions).

4. **Natural-hazard mitigation for utilities and transportation lifelines.** The Economic Development Administration has provided grants to several communities to enhance utility and transportation lifeline facilities. Notable among these grants are efforts to raise the elevation of roads, railroads, electrical substations, water pumping stations, and other infrastructure to better resist flood, and to move electrical transmission lines underground to better resist wind and ice loads. Furthermore, some utilities and transportation lifelines have performed costly mitigation with EDA funding. The California Department of Transportation (Caltrans) strengthened more than 2,200 bridge structures to better resist earthquake forces, at a cost of more than \$12 billion. Electricity retailers in earthquake country, such as Los Angeles Department of Water and Power, have strengthened substation buildings and equipment, creating a more-resilient electric grid. Water agencies have begun similar efforts to create resilient water-supply grids, for example the East Bay Municipal Utility District and the Los Angeles Department of Water and Power. The project team sought to estimate the benefits and costs of various kinds of natural-hazard mitigation measures for utility and transportation infrastructure: all those represented by EDA grants, plus highway bridge seismic mitigation and resilient grids for electricity and water supply.
5. **Retrofit of existing private-sector buildings.** Throughout the country, private-sector building owners have been retrofitting existing buildings to better resist floods, hurricanes, earthquakes, and fires. This study seeks to estimate the benefits and costs of some of the most common retrofit measures, focusing on residential buildings.

The Interim Study does not address all categories of natural hazard mitigation, so inferences about the cost effectiveness of those other categories should not be made. For example, the study does not address exceeding code requirements either to resist tornadic winds or to further elevate structures in Coastal A zones. As it continues its work, the project team will address many of these categories of natural hazard mitigation, as discussed in the next section.

The project team estimated the benefits of natural hazard mitigation in terms of avoided future losses. The team considered reductions in all major loss categories: property repairs, casualties, and direct and indirect business interruption (BI). Several benefit categories could not be readily quantified in dollar terms, so the project team acknowledged them qualitatively. (See Box 1-2 for benefit categories, both tangible and intangible.) Not every benefit category in this list can be quantified, and some of the remainder are notoriously difficult to estimate. The project team also distinguished BCRs by peril, focusing on four of the most common and damaging sudden-onset hazards that damage property and hurt people across the United States: flood, wind, earthquake, and fire at the wildland-urban interface (WUI). These are the same perils examined in the 2005 Mitigation Saves study, with the addition of fire at the WUI. As in the 2005 Mitigation Saves study, this Interim Study limits its estimates of avoided future losses mostly to the owners

---

<sup>8</sup> The IEBC establishes target performance levels for existing buildings and ensures a more consistent degree of performance.

and tenants of mitigated buildings, and ignores the fact that when those people lose money, for example, to pay for repairs, the money gets transferred to somebody else, such as construction contractors.

### Box 1-2. Benefit Categories Considered

1. Reduced future property repair and reconstruction costs.
2. Reduced additional living expenses (ALE) and other costs of residential displacement.
3. Reduced future losses associated with direct BI, meaning the loss of revenue resulting from damage at the facility in question that prevents it from being used for production, or in the case of transportation infrastructure, the added costs associated with longer travel times.
4. Reduced future losses associated with indirect BI, meaning the loss of revenue resulting from damage at other facilities.
5. Lower insurance costs.
6. Reduced costs for emergency response.
7. Reduced loss of service to the community, especially for fire stations and hospitals.
8. Lower maintenance costs.
9. Improved public-health outcomes, especially deaths, nonfatal injuries, and post-traumatic stress disorder (PTSD). Public health outcomes are expressed in terms of incidents and are then monetized using the acceptable cost to avoid future statistical deaths and injuries. Note that one can estimate the acceptable costs to avoid mental-health impacts (not addressed in the 2005 study), which Bloom et al. (2011) suggest is a dominant contributor to the global economic burden of non-communicable diseases.
10. Fewer job losses and some job creation.
11. Lower environmental impacts.
12. Reduced historical and other cultural impacts.
13. Impact on tax revenues.

The project team examined design objectives for new buildings from the perspective of an owner or developer who is choosing to either meet or exceed the 2015 I-Codes, or, in the case of the 2015 *International Wildland-Urban Interface Code (IWUIC)*, simply adopting it. The project team used the 2015 editions as the baseline to examine the costs and benefits of exceeding code requirements for new design. Where a community adopted an older version of the code or no code, the BCR will change.

A few owners have chosen to exceed code minima, such as the California Institute of Technology (Caltech), which for several decades constructed its buildings to be 50% stronger than the code required. At least two consulting clients of project team members currently design some of their new buildings to be 25% stronger than the code requires. A local jurisdiction could make the same choice for portions of its community. Its decision-makers would benefit from knowing: (1) the reasonable options; (2) the costs and benefits of such options; and (3) who would bear or enjoy the costs and benefits. Costs include the up-front expenses required to enjoy the possible benefits. Up-front expenses might include higher costs of

design, construction, enforcement and maintenance. Stakeholders would realize different benefits; building owners would benefit from reduced building repair costs, tenants would benefit from reduced content repair costs, and the broader community would benefit from reduced indirect BI losses.

Results might vary by peril, geographic location, socioeconomic status, and economic sector. The project addresses these questions by imagining a future building stock composed entirely of buildings that comply with the current I-Codes (especially the 2015 IBC, IRC, and IWUIC), and alternatively, a different future building stock composed of buildings designed to exceed I-Code requirements, such as with greater strength, stiffness, height above BFE, etc. In the case of the 2015 IWUIC, the project team addressed the questions by imagining that new buildings do not comply with that code, and then again supposing that new buildings do comply. The Interim Study identifies locations where designing to exceed I-Code requirements appears to be cost effective, and estimates the degree to which designing to exceed I-Code requirements in those locations makes economic sense on a BCR basis. Box 1-3 explains how the project team's approach to consider only measures that appear cost effective do not produce bias.

For designing to exceed the 2015 I-Codes (or designing to comply with the 2015 IWUIC), the project team estimated the costs and benefits for 1 year of new buildings, e.g., assuming that all new buildings built in 2018 are built to comply with the stricter requirements, but only where it is cost effective to do so.

For design to exceed 2015 I-Code requirements, the Interim Study estimates the costs and benefits of narrowly defined changes. For example, what if a California city required that all new buildings must be at least 50% stronger and stiffer than the I-Codes require. In that case, the ASCE 7-10 (American Society of Civil Engineers Structural Engineering Institute 2010) parameter  $S_{DS}$  could be calculated as equal to  $S_{MS}$ , rather than  $2/3 \times S_{MS}$ , with an unchanged drift limit. Such a narrowly defined enhancement would not involve other requirements, such as changes in wind resistance that might be stated elsewhere in the code. The project team estimated the costs and benefits associated with just the one enhancement, ignoring how the enhancement for seismic resistance might affect wind resistance.

The Interim Study examines the cost-effectiveness of adopting 2018 I-Codes, relative to codes in force in 1990 or that approximate time. It measures the costs and benefits of building all new buildings in one year to comply with certain aspects of the 2018 IBC and IRC, compared with building the same buildings as if 1990-era codes applied. (Note that the analysis assumes all new buildings are built to comply with 2018 I-Codes, not just those where it is cost effective to do so.) In particular, 1990-era construction in earthquake-prone regions would comply with strength and stiffness requirements of the 1988 Uniform Building Code (International Conference of Building Officials 1988). In hurricane-prone regions along the Gulf and Atlantic coasts, 1990-era construction is represented by detailing requirements of the National Building Code (Building Officials and Code Administrators 1990) and Southern Standard Building Code (Southern Building Code Congress International 1991). For buildings subject to riverine flooding in special flood hazard areas, 1990-era construction is represented by requirements of the National Flood Insurance Program (NFIP) that buildings be built so that their first floor is at least at base flood elevation, as opposed to 1 ft higher, as required by 2018 I-Codes.

## NATURAL HAZARD MITIGATION SAVES:

The Interim Study examines the costs and benefits of a variety of mitigation measures for utilities and transportation infrastructure, focusing on grants offered by the Economic Development Administration of the U.S. Department of Commerce. These grants supported mitigation of roads, railroads, water and wastewater facilities, and power and telecommunications facilities to better resist flooding, wind, and ice loads. In addition, the Interim Study examines the cost effectiveness of a program by the California Department of Transportation to seismically retrofit southern California highway bridges. It also examines the cost effectiveness of some hypothetical but highly realistic measures to make electric and water distribution systems more seismically resilient by the hardening of key elements: electric substations and select buried pipes in the water system, creating so-called resilient grids.

The Interim Study examines the cost effectiveness of 23 years of federal mitigation grants, mostly for the retrofit of existing public-sector buildings. Cost effectiveness for each kind of mitigation activity accounts for the benefits to all of society, considering benefits to building owner, tenants, and the community in general. In the case of federal grants, the beneficiaries include the funder, grant recipient, tenants, and the community near the mitigation activity.

A number of different stakeholders might be interested in the results of the Interim Study. Box 1-3 identifies categories of stakeholders and intended audiences.

### Box 1-3. Stakeholder Categories and Intended Audience

<b>Insurers:</b>	Primary and reinsurance companies, state insurance authorities
<b>Finance:</b>	Mortgage companies, appraisers and real estate brokers Loan organizations: Property Assessed Clean Energy (PACE), tax increment financing, American public-private partnership (P3) model, Community Development Financial Institution (CDFI), green banks, cat bond issuers, real estate investment trusts (REITs), bond rating agencies
<b>Designers:</b>	Architects, land use planners, structural and civil engineers and their professional societies
<b>Builders:</b>	Developers, builders, contractors, and their trade associations
<b>Public sector:</b>	Mayors, county supervisors, city and county council members, building officials, community development agencies, fire departments, emergency responders and managers, state legislatures, other state agencies utility commissions, state architects, state departments of transportation, housing, school boards, U.S. Congress and federal agencies: FEMA, HUD, Small Business Administration (SBA), EDA, DOT, Fannie Mae, Federal Housing Administration (FHA), Freddie Mac, Department of Veterans Affairs (VA), Department of Energy (DOE), Department of Agriculture (USDA)
<b>Private sector:</b>	Homeowners, large businesses, small businesses, and utilities
<b>Outreach:</b>	Media, universities, hazard-related organizations, building-related organizations



## NATURAL HAZARD MITIGATION SAVES:

The project team aimed first to produce the Interim Study, documenting its methodologies and findings. The project team set out to assure quality through a rigorous peer review process, in which each section was reviewed by highly qualified experts working independently of the project team. The Interim Study represents an “independent inquiry,” meaning the authors are independent of the funding organizations for the Interim Study.

Among its next steps, the project team will begin estimating the cost effectiveness of retrofits of existing private-sector buildings to enhance their resilience to natural disasters. The project team will consider mitigation efforts to reduce risk from flood, wind, earthquake, and fire at the WUI that meet at least two of three criteria:

- Commonly implemented, but probably cost effective.
- Conducive to reducing uninsured losses.
- Of particular interest to the National Fire Protection Association (NFPA) and HUD, because the retrofit solves a deficiency in many HUD-funded buildings, the retrofit is affordable to HUD occupants, or HUD provides funding for the retrofit measure.

Mitigation strategies for potential study are identified and prioritized in Table 1. In its ongoing research, the project team will examine all priority-1 measures, at least one priority-2 measure for each peril, and, possibly, priority-3 perils if it is found that the priority-1 and priority-2 measures can be evaluated without exhausting the available time and budget. Based on input from sponsors, oversight committee members, and stakeholders, the project team will determine which priority-3 measures to examine.

**Table 1-1:** Retrofit measures to be examined in the ongoing study.

Peril	Mitigation Measure	Priority
Flood	Building elevation	1
	Land use planning	1
	Buyout	1
	Wet flood proofing	2
	Dry flood proofing of commercial buildings	3
Wind	Manufactured housing engineered tie-down system (ETS)	1
	IBHS FORTIFIED Home-Hurricane for existing homes	1
Earthquake	Retrofit of soft-story wood frame multifamily dwellings	1
	Manufactured housing engineered tie-down system (ETS)	1
	Restrain furnishings, fixtures, and equipment	1
	Foundation anchors & strengthen cripple walls to older wood buildings	2
	Seismic gas shutoff valves	3
	Stronger unreinforced masonry bearing-wall (UMB) buildings	3

## NATURAL HAZARD MITIGATION SAVES:

Peril	Mitigation Measure	Priority
WUI	Retrofit to approach IWUIC	1
	Land use planning	1

The Institute will release data on additional mitigation measures as they become available. Additional future work, pending identification of funding resources, will examine business continuity planning (BCP) and disaster recovery (DR), as well as mitigation activities performed by federal agencies, such as the National Oceanic and Atmospheric Administration (NOAA) early warning system and the USACE levee programs.

### 1.3. ORGANIZATION OF INTERIM REPORT





Chapter 1 introduces the project team's objectives and some of the important considerations in quantifying the costs and benefits of mitigation. Chapter 2 summarizes the findings for buildings. Chapter 3 briefly recaps past efforts to perform similar or related studies. Chapter 4 presents the methods selected to meet the Interim Study objectives for buildings. Chapter 5 summarizes the data acquired for buildings. Chapter 6 presents methods, data, and findings of an analysis of the costs and benefits of natural-hazard mitigation for utilities and transportation lifelines. Chapter 7 lists the references cited elsewhere in the Interim Study. Miscellaneous additional documentation appears in the appendices with the aim of informing decisions by a particular stakeholder group.

## 2. Findings

### 2.1. SUMMARY OF RESULTS

Based on the mitigation measures the project team examined for the Interim Report, mitigation remains a solid investment. Table 2-1 summarizes benefit-cost ratios for mitigation measures the team examined. Box 2-1 explains the mitigation categories and what the BCRs mean. The sections that follow provide more details about the results and key considerations in determining mitigation measure- and hazard-specific BCRs.

Table 2-1: Benefit-cost ratio by Hazard and Mitigation Measure.

	ADOPT CODE	ABOVE CODE	BUILDING RETROFIT	LIFELINE RETROFIT	FEDERAL GRANTS
<b>Overall Benefit-Cost Ratio</b>	<b>11:1</b>	<b>4:1</b>	<b>4:1</b>	<b>4:1</b>	<b>6:1</b>
<b>Cost (\$ billion)</b>	<b>\$1/year</b>	<b>\$4/year</b>	<b>\$520</b>	<b>\$0.6</b>	<b>\$27</b>
<b>Benefit (\$ billion)</b>	<b>\$13/year</b>	<b>\$16/year</b>	<b>\$2200</b>	<b>\$2.5</b>	<b>\$160</b>
 <b>Riverine Flood</b>	<b>6:1</b>	<b>5:1</b>	<b>6:1</b>	<b>8:1</b>	<b>7:1</b>
 <b>Hurricane Surge</b>	not applicable	<b>7:1</b>	not applicable	not applicable	not applicable
 <b>Wind</b>	<b>10:1</b>	<b>5:1</b>	<b>6:1</b>	<b>7:1</b>	<b>5:1</b>
 <b>Earthquake</b>	<b>12:1</b>	<b>4:1</b>	<b>13:1</b>	<b>3:1</b>	<b>3:1</b>
 <b>Wildland-Urban Interface Fire</b>	not applicable	<b>4:1</b>	<b>2:1</b>	not applicable	<b>3:1</b>

Copyright © 2019 The National Institute of Building Sciences

The project team selected the mitigation measures examined here in collaboration with an oversight committee of technical experts, a group of stakeholders who participated in a workshop in February 2017, and the sponsors’ leaders and subject matter experts. They selected some measures to be directly comparable to the 2005 study. Other measures were selected because they are widely used within the private sector. Still others were deemed to be highly promising. The group selected code adoption because the I-Codes represent one of the most effective methods to build resilience into the building stock.

Though some mitigation categories may be highly cost-effective, the project team has not examined them because the necessary funding has not yet been secured. For example, the project team has not examined business continuity planning (BCP) and disaster recovery (DR) or direct actions by the federal government, such as flood control by the U.S. Army Corps of Engineers or earthquake early warning by the U.S. Geological Survey.

### Box 2-1: What the BCR Numbers Mean

***Exceed Commonly Adopted I-Code Requirements.*** Most states and communities adopt recent editions of the IBC and IRC, typically one of the most recent three editions. The IWUIC, on the other hand, is not as widely adopted. The project estimated the benefits and costs if communities exceeded certain aspects of the commonly adopted requirements, that is, if they exceeded some aspects of the 2015 editions of the IBC and IRC, or adopted the (less-frequently used) 2015 IWUIC, and built all new buildings for one year accordingly. For riverine and coastal flooding, the research considered building homes higher than the required 1-foot above BFE. For earthquake: building all new buildings (residential, commercial, industrial, etc.) stronger and stiffer. For hurricane wind: complying with IBHS FORTIFIED Home and Commercial Hurricane programs. In some places, doing so would be cost effective, in others, not. If communities exceeded the commonly adopted requirements only where it were cost-effective to do so, society would pay \$3.7 billion more construction and maintenance costs, but avoid \$15.9 billion in future losses, for a BCR of 4:1. When considered singly, each peril offers its own costs and benefits, with BCRs between 4:1 and 7:1. (In this and the following categories, the total BCR is not the average of peril-specific BCRs, but rather is the ratio of the sum of the peril-specific benefits to the sum of their costs, which mathematically does not have to equal the average of the peril-specific BCRs.) Summary information can be found in section 2.2.

***Meet the Latest Editions of Commonly Adopted Code Requirements.*** Codes develop over time. The project team compared costs and benefits of one year of new construction to comply with the 2018 I-Codes versus design requirements in codes used in 1990. The project team examined code aspects related to riverine flood (building homes higher above base flood elevation), wind (a number of detailing requirements for residential and commercial buildings), and earthquake (requirements for all new buildings that made them stronger and stiffer). In total, these aspects of the 2018 I-Codes make new buildings cost about \$1.2 billion more than they would under 1990 design requirements, but avoid \$13 billion in future losses, for a BCR of 11:1. Considered separately, the perils produced BCRs of 6:1 to 12:1. See Section 2.3 for summary results.

***Retrofit of Existing Private-Sector Buildings.*** Building codes generally do not apply retroactively, so older buildings commonly suffer from deficiencies that newer building codes and construction practices mitigate. The project team examined 15 common or promising retrofit measures for existing, mostly residential, private-sector buildings: five measures to reduce flood damage, two to reduce damage from hurricane winds, seven seismic retrofit measures, and one measure to reduce damage to existing buildings in the wildland-urban interface. If implemented in all buildings where it would be cost effective to do so, these retrofit measures would cost \$520 billion, but would ultimately save society \$2.2 trillion, for a savings of \$4 for every \$1 spent. See Section 2.6 for details.

**Utilities and Transportation.** Society relies on roads, electricity, water, wastewater, and other lifelines. The project estimated the costs and benefits of EDA-funded grants that mitigate flood and wind risk to utilities and transportation infrastructure. The team considered a large retrofit program by the California Department of Transportation that made Southern California highway bridges more earthquake resistant. Finally, it considered hypothetical but realistic retrofit programs to make the electricity and water grids more earthquake resilient. In total, the real (not hypothetical) efforts cost \$590 million but will avoid \$2.5 billion in future losses, for a BCR of 4:1. Section 2.4 summarizes the results.

**Federally Funded Grants.** The project team examined mitigation grants for buildings made between 1993 to 2016 by FEMA and HUD. Grants mostly addressed risk from riverine flood, wind, earthquake, and fire at the wildland-urban interface. The project estimated the dollar benefit of all grant-supported mitigation to be \$158 billion, at a construction cost of \$27.4 billion, for a BCR of 6:1. BCRs for different perils range between 3:1 and 7:1. See Section 2.5 for summary results

The perils examined here were selected to be comparable to the 2005 study. Others were added because they contribute substantially to nationwide losses (fire at the wildland-urban interface) or are important in certain regions (coastal flooding in the region subject to wave action, called the V-zone). Some important perils were largely neglected (e.g., tornado) because necessary hazard information was in flux at the time of writing, and any analysis might have quickly become obsolete. Other perils, such as heat events and drought have not yet been examined for lack of funding.

Why does the study present features of BCRs that represent the benefits of mitigation achievable by various kinds of mitigation measures and various perils? While the project team recognized the desire to have a single BCR that would facilitate widespread dissemination of the project results, providing such an aggregate number might be more useful when other parts of the Interim Study are completed.

The 2005 study produced the widely cited result that every \$1 invested in mitigation produced \$4 in future loss reduction. Despite the specific guidance that the result represented only a single, very narrow set of mitigation strategies, specifically those funded through FEMA mitigation grants, the BCR has been used to justify all types of mitigation strategies. *The 2019 Report* provides an updated examination of the benefits of federal agency grant programs (including the addition of EDA and HUD), resulting in a \$6 benefit for every \$1 invested. While not a direct replacement, when used to describe federal grant programs, the 6:1 BCR can be used in place of the original 4:1.

The report also includes the results from the examination of three new sets of mitigation measures: (1) exceeding the 2015 IBC and IRC and implementing the 2015 IWUIC, (2) Adopting current codes, (3) retrofitting existing private-sector buildings, and (4) retrofitting utilities and transportation infrastructure. While these mitigation measures are an important addition to the dialogue around mitigation, they still only represent a few of many practical strategies.

In lieu of providing a result based on a limited set of mitigation measures, the project team elected to provide BCRs for each strategy individually, with the result likely to change as new mitigation strategies are studied and added to the aggregate number. Once the project team has identified BCRs for a sufficient number of mitigation strategies, it will provide an aggregated number representing the overall benefit of mitigation.

## 2.2. RESULTS FROM DESIGNING TO EXCEED COMMONLY ADOPTED 2015 I-CODE REQUIREMENTS

This section presents benefit-cost analysis (BCA) results of designing new buildings to exceed 2015 IBC requirements for riverine flood, hurricane storm surge in coastal V-zones, hurricane wind, and earthquake, or to comply with the requirements of the 2015 IWUIC (in the case of wildfire). Because the IWUIC is less widely adopted than the other codes, so the adoption of the 2015 IWUIC would represent an increase in common design requirements, and in many places would reduce losses to more than offset the increased construction cost.

### 2.2.1. Designing to Exceed 2015 I-Code Requirements for Riverine Flood

The cost to build all new homes to the BFE + 5 feet for 1 year is approximately \$900 million. This would produce approximately \$4.2 billion in benefits, for an aggregate BCR of approximately 5:1, e.g., \$5 saved for every \$1 spent to build new homes higher out of the floodplain.

If all new residences in the United States in the 1% annual chance floodplain were designed to BFE + 5 and achieved the overall average BCR of 4.67 shown in Figure 2-2, what would be the total societal costs and benefits for 1 year of new construction? There are approximately 5.1 million National Flood Insurance Program (NFIP) policies currently in force in the United States.<sup>9</sup> NFIP's market penetration (ratio of houses that are insured to the total number that could be insured) is approximately 0.5.<sup>10</sup> Together, these two statistics suggest approximately 10.2 million U.S. homes are currently in the 1% annual chance floodplain. On average, construction adds about 1% to the existing building stock annually, which suggests that 102,000 houses will be built in one average year in the 1% annual chance floodplain (1% of 10.2 million = 102,000). The additional cost to build to BFE + 5 rather than BFE + 1 is approximately \$8,900 for a single house, or about \$900 million for 102,000 new houses. With a BCR of 4.67, the benefits would total about \$4.2 billion (\$900 million × 4.67). The benefit comes from reduction in property losses, additional living expenses (ALE), sheltering, and indirect BI, casualties and post-traumatic stress disorder (PTSD), and insurance, in the proportions shown in Figure 2-1.

---

<sup>9</sup> <https://www.fema.gov/total-policies-force-calendar-year>

<sup>10</sup> [https://www.fema.gov/media-library-data/20130726-1602-20490-2804/nfip\\_eval\\_market\\_penetration\\_rate.pdf](https://www.fema.gov/media-library-data/20130726-1602-20490-2804/nfip_eval_market_penetration_rate.pdf), pg.

## NATURAL HAZARD MITIGATION SAVES:

### **Benefit: \$4.2 billion**

36% – Property: \$1,500

22% – Additional living expenses and direct business interruption: \$930

11% – Indirect business interruption: \$470

7% – Insurance: \$300

24% – Casualties and PTSD: \$1,000

Millions 2018 USD

**Cost: \$0.9 billion**

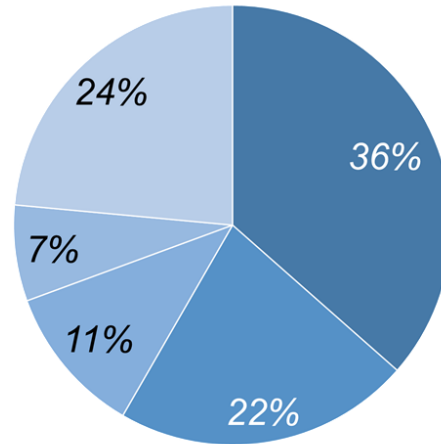

Figure 2-1: Nationwide benefits by category for designing to exceed 2015 I-Code requirements for flood.

In Figure 2-1, the label “additional living expenses and sheltering” means the cost to residents or to the rest of society resulting from the loss of use of residential property—the analog of direct BI in residential property. Indirect BI refers to the net reduction in economic activity resulting from the loss of use of the residential property, aside from the ALE. The same is true of several other pie charts in this chapter. In some cases, the living expenses and indirect BI are combined in a pie chart, or direct and indirect BI. Where practical, they are separated.

The Interim Study estimates the nationwide effectiveness of designing and building all new homes in 1 year in the 1% annual chance floodplain to exceed 2015 I-Code requirements. It does not purport to present a precise estimate of benefits that might be realized on a case-by-case local basis (e.g., census tracts), or if such precise calculations were carried out on a local basis in every floodplain across the entire nation and then summed. Local results for a particular house or for all the houses in a particular community would probably differ from the average presented here. The true nationwide benefits and costs, if they could be calculated for every county in the United States, would also differ by some unknown amount from the estimates this report provides. However, more often than not there would probably be a benefit to mitigating.

The project team used a purposive sampling technique of typical cases of communities that represent common floodplain conditions and residential structures found in riverine flooding across the United States, as described in Section 4.11.2. Table 2-2 summarizes the statistics for the four counties studied. Results are reported for each foot of increase in elevation at a 2.2% discount rate (the approximate cost of borrowing) and an assumed 75-year economic life of a residence. (See Appendices H and I for a discussion of the discount rate and of the economic life of a building, respectively.) The table shows the benefits and costs for additional elevation above code-minimum: BFE + 2 means new design to 2 feet above BFE, for example. “Cost” refers to the total additional cost of building to the specified height rather than I-Code minimum (BFE + 1). It is the difference in construction cost between BFE +  $n$  feet (e.g., “BFE + 2 means 2 feet above BFE) and BFE + 1. Benefit means the present value of benefits resulting from the

## NATURAL HAZARD MITIGATION SAVES:

additional elevation. BCR refers to the ratio of the two.  $\Delta$ Cost refers to the difference in additional cost to build to BFE +  $n$  feet rather than BFE + ( $n - 1$ ) feet, or the additional cost of one additional foot of elevation from BFE + ( $n - 1$ ) to BFE +  $n$ .  $\Delta$ Benefit refers to additional benefit of building to BFE +  $n$  rather than BFE + ( $n - 1$ ).  $\Delta B/\Delta C$  refers to the ratio of  $\Delta$ Benefit to  $\Delta$ Cost. Each additional foot of elevation is considered cost effective if  $\Delta B/\Delta C > 1$ .

$\Delta B/\Delta C$  is greater than 1 for all elevations considered. Table 2-2 suggests that designing buildings with increased elevation above the I-Code 2015 requirement (BFE + 1 foot) is generally cost effective, at least up to BFE + 5 feet (4 feet more than the 2015 IBC requires) in these four counties. Figure 2-2 shows results for each county separately. Figure 2-3 shows average BCR and average  $\Delta B/\Delta C$  values, e.g., averaging over these four counties. While Monroe County, Georgia, has higher values of BCR and  $\Delta B/\Delta C$  than the other three counties, all four counties show consistent results, in that all suggest greater elevation passes the BCR > 1 and  $\Delta B/\Delta C > 1$  tests of cost effectiveness.

**Table 2-2:** Summary BCR results for sampled counties.

Height	Cost	Benefit	BCR	$\Delta$ Cost	$\Delta$ Benefit	$\Delta B/\Delta C$
Allen County, IN						
BFE + 2	\$ 793,972	\$ 3,275,548	4.13	\$ 793,972	\$ 3,275,548	4.13
BFE + 3	\$ 1,191,106	\$ 5,665,808	4.76	\$ 397,134	\$ 2,390,260	6.02
BFE + 4	\$ 1,588,023	\$ 7,614,300	4.79	\$ 396,917	\$ 1,948,493	4.91
BFE + 5	\$ 2,022,687	\$ 8,418,696	4.16	\$ 434,663	\$ 804,396	1.85
Elkhart County, IN						
BFE + 2	\$ 2,537,343	\$ 9,534,636	3.76	\$2,537,343	\$ 9,534,636	3.76
BFE + 3	\$ 3,806,507	\$ 15,925,500	4.18	\$1,269,164	\$ 6,390,864	5.04
BFE + 4	\$ 5,074,995	\$ 19,968,948	3.93	\$1,268,488	\$ 4,043,448	3.19
BFE + 5	\$ 6,464,192	\$ 22,607,799	3.50	\$1,389,197	\$ 2,638,850	1.90
Fulton County, GA						
BFE + 2	\$ 3,516,281	\$ 14,810,326	4.21	\$3,516,281	\$14,810,326	4.21
BFE + 3	\$ 5,275,131	\$ 28,508,125	5.40	\$1,758,849	\$13,697,800	7.79
BFE + 4	\$ 7,033,070	\$ 39,734,000	5.65	\$1,757,940	\$11,225,874	6.39
BFE + 5	\$ 8,958,412	\$ 48,776,327	5.44	\$1,925,342	\$ 9,042,327	4.70
Monroe County, GA						
BFE + 2	\$ 185,855	\$ 1,619,143	8.71	\$ 185,855	\$ 1,619,143	8.71
BFE + 3	\$ 270,575	\$ 2,868,257	10.60	\$ 84,720	\$ 1,249,113	14.74
BFE + 4	\$ 359,165	\$ 3,450,872	9.61	\$ 88,591	\$ 582,615	6.58
BFE + 5	\$ 452,175	\$ 3,826,023	8.46	\$ 93,010	\$ 375,151	4.03



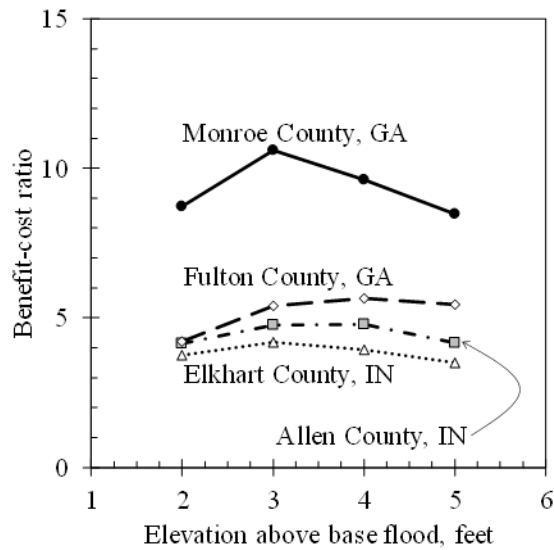

Figure 2-2: BCR by sample county and additional elevation.

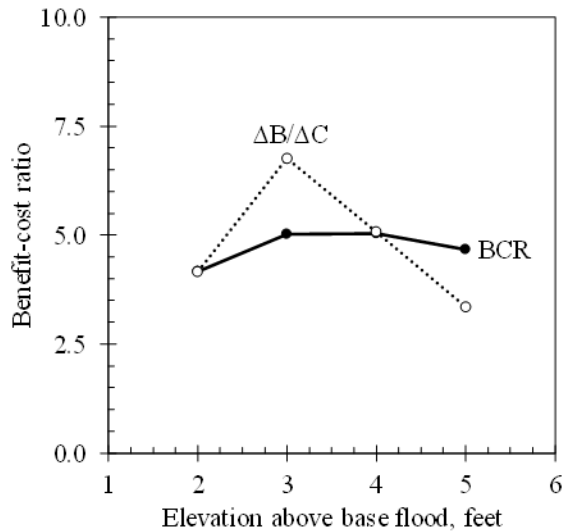

Figure 2-3: BCR and  $\Delta B/\Delta C$  to build new buildings higher above BFE than required by the 2015 IBC.

Some key observations are worth noting. First, there are differences between overall BCR values (a BCR at given elevation compared to BFE + 1) and  $\Delta B/\Delta C$  estimates. Variations among BCR values tend to be more subtle than drastic variations among  $\Delta B/\Delta C$  values, especially at higher elevations. That is expected: the more height above BFE, the more costs compared with the previous elevation but lesser benefit;  $\Delta B/\Delta C$  measures that incremental effect, while BCR adds the last-foot costs and benefits along with all the

others, so the cost effectiveness of the last foot gets concealed to some extent. It is generally cost effective to construct a new building higher than BFE + 1, even up to 4 additional feet.

Second, BCR values seem to decline beyond a certain threshold. The project team found that with more than 4 to 5 feet of additional elevation, BCR and  $\Delta B/\Delta C$  diminished. This trend was consistent across all four of the sample counties and is likely to be consistent in similar communities across the nation.

Finally, it is obvious that variations among BCR values are specific to locational and community conditions (Table 2-2). This is evident by the noticeable difference in BCR values between Monroe County, Georgia, and the other three counties, and also among the other three counties themselves. Monroe County has a considerably higher percentage of open foundations than what is present in the other three counties. The BCR values for Monroe County are actually similar to those seen in the analysis of the effectiveness of elevation in coastal communities that are also dominated by open foundations. Although closed foundations are more common in the other counties, variations among BCR values still occur because of site-specific conditions such as level of inundation or because of socioeconomic characteristics, such as variations in construction costs or distribution of business activities within the floodplain communities.

To further investigate the latter observation, the project team tested a number of regression models using the BCR as a dependent variable. The available, relevant independent variables include elevation above BFE, foundation type, number of stories, and foundation size. One of the statistically significant models accurately predicted BCRs as a function of two independent variables: (1) elevation above BFE and (2) foundation type. This regression analysis produced an R<sup>2</sup> value of 0.81, which means that 81% of variance in BCR among the sampled counties in a 0.2% annual chance floodplain can be explained by building elevation and foundation type. Societal and hazard conditions probably explain the remaining 20% of variance.

### 2.2.2. Designing to Exceed 2015 I-Code Requirements for Hurricane Surge

Building new single-family dwellings higher above the BFE than the 1 foot required by the 2015 IRC appears to be cost effective in coastal surge areas identified as V or VE by FEMA in all states. Surge in coastal V-zones is different from riverine flooding, and so its costs and benefits are different.

When the incrementally efficient maximum (IEMax)<sup>11</sup> of the increase in building height is assessed on a state level, the aggregate BCR (summing benefits and costs over all states) is approximately 7:1, e.g., \$7 saved for every \$1 spent to build new coastal buildings in V- and VE-zones higher above the shoreline. It would cost approximately \$7 million extra to build all new buildings to the IEMax elevation above BFE for 1 year, and would produce approximately \$51 million in benefits.

---

<sup>11</sup> See Section 4.5 for a discussion on the determination of the incrementally efficient maximum as utilized in the Interim Study.

## NATURAL HAZARD MITIGATION SAVES:

The results strongly suggest that greater elevation of new coastal single-family dwellings in V-zones is widely cost effective. (The study did not examine greater elevation of buildings in coastal A-zones because of data limitations.) All states have an IEMax building height above code of at least 5 feet. The IEMax elevation is quite high for several reasons. These include the relatively low cost of building a foot higher compared to the price of a house. These costs and benefits refer to building new coastal single-family dwellings higher above BFE, not of elevating existing houses, which would be much more expensive and would result in a lower BCR.

Figure 2-4 illustrates the contribution to benefit from the various benefit categories, led by reduced property loss (about 69%), followed by time-element losses (ALE and indirect BI losses, 19%), insurance (12%), and acceptable costs to avoid deaths and nonfatal injuries at much less than 1%. Figure 2-4 uses state-level estimates for the IEMax elevation above 2015 IRC requirements.

### **Benefit: \$51 million**

68% – Property: \$35.0

14% – Additional living expenses and direct business interruption: \$7.0

12% – Insurance: \$6.0

6% – Indirect business interruption: \$3.0

0% – Casualties and PTSD: \$0.2

*Millions 2018 USD*

**Cost: \$7 million**

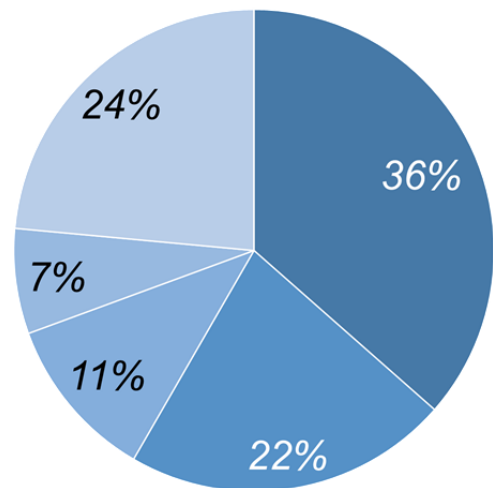

Figure 2-4: Benefits and costs of building new coastal houses in V-zones above 2015 I-Code requirements for 1 year.

The IEMax additional height varies by state, as illustrated in Table 2-4. The benefits of building above code descend from very cost effective, with a BCR of approximately 17:1 at BFE + 2 ft, to just marginally cost effective at 8 and 9 feet, with values just above 1. Table 2-3, Figure 2-5 and Figure 2-6 illustrate these results. They show estimated benefits and costs for 1 year of new construction, which as discussed in Chapter 4, are estimated as 1% of the existing building stock in coastal V-zones (not all coastal residences—just those in V-zones).

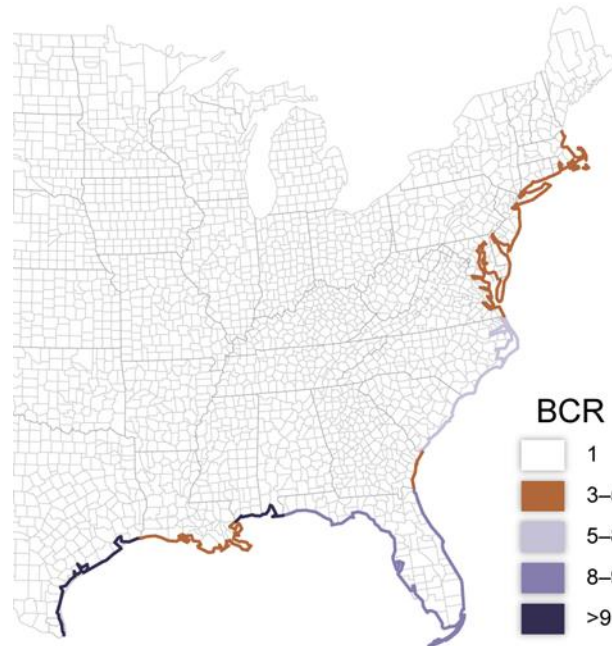

Figure 2-5: BCR of coastal flooding mitigation by elevating homes above 2015 IRC requirements (by state).

Figure 2-6A demonstrates that all building elevations assessed are cost effective, with diminishing returns. The curve of change in benefit divided by change in cost ( $\Delta B/\Delta C$ ) in Figure 2-6B shows that the increase in elevation is cost effective to 9 feet, with the incremental change in benefit exceeding the incremental change in cost by at least a factor of 1.0 (the threshold indicated by the horizontal dotted line with a y-value of 1.0).

Table 2-3: Benefits and costs of building new coastal 1-story single-family dwellings higher above estimated BFE (all dollar figures in present value, \$ millions, for 1 year of new construction).

Height (ft)	Property loss	ALE & indirect BI	Insurance fees	Death, injury	Benefit B	Cost C	B/C	$\Delta B$	$\Delta C$	$\Delta B/\Delta C$
BFE + 2	\$ 10.67	\$ 2.80	\$ 1.81	\$0.05	\$15.33	\$0.90	16.9	\$15.33	\$0.90	16.9
BFE + 3	\$ 17.60	\$ 4.67	\$ 2.99	\$0.09	\$25.36	\$1.80	14.1	\$10.02	\$0.90	11.2
BFE + 4	\$ 24.66	\$ 6.76	\$ 4.19	\$0.12	\$35.73	\$2.71	13.2	\$10.37	\$0.90	11.5
BFE + 5	\$ 27.96	\$ 7.70	\$ 4.75	\$0.14	\$40.55	\$3.60	11.2	\$4.82	\$0.90	5.4
BFE + 6	\$ 31.11	\$ 8.74	\$ 5.29	\$0.15	\$45.28	\$4.50	10.1	\$4.73	\$0.90	5.3
BFE + 7	\$ 32.66	\$ 9.12	\$ 5.55	\$0.16	\$47.50	\$5.41	8.8	\$2.22	\$0.90	2.4
BFE + 8	\$ 34.21	\$ 9.61	\$ 5.82	\$0.17	\$49.80	\$6.30	7.9	\$2.30	\$0.90	2.6
BFE + 9	\$ 34.93	\$ 9.80	\$ 5.94	\$0.17	\$50.84	\$7.20	7.1	\$1.04	\$0.90	1.2
BFE + 10	\$ 35.64	\$10.07	\$ 6.06	\$0.17	\$51.94	\$8.11	6.4	\$1.10	\$0.90	1.2
BFE + 11	\$ 35.88	\$10.12	\$ 6.10	\$0.17	\$52.27	\$9.01	5.8	\$0.33	\$0.90	0.4

## NATURAL HAZARD MITIGATION SAVES:

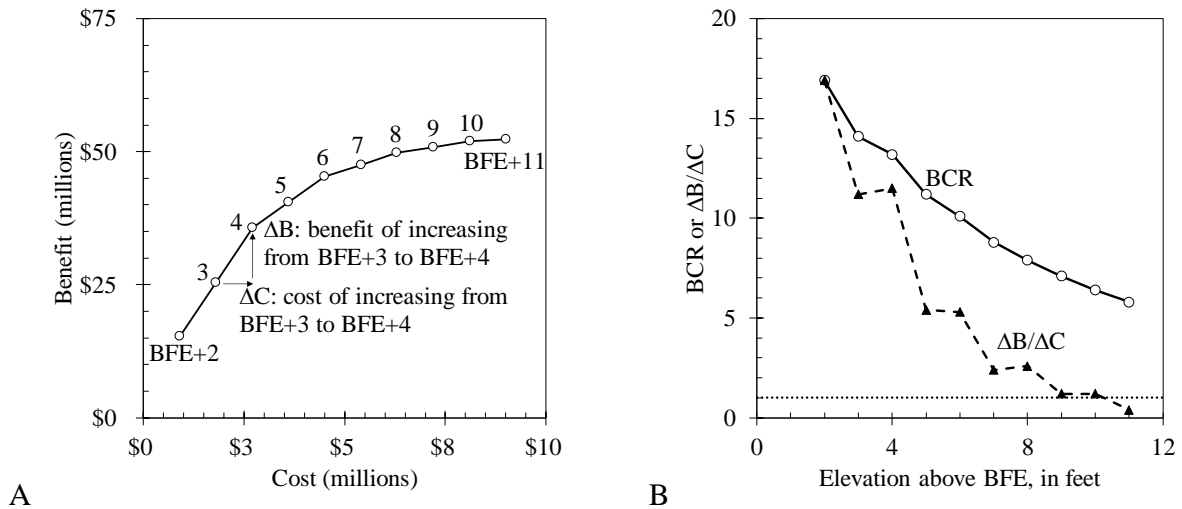

**Figure 2-6:** Benefits and costs of building new coastal single-family dwellings higher above the requirements of the 2015 IRC: (A) benefits versus costs, (B) BCR and  $\Delta B/\Delta C$  versus first floor elevation.

**Table 2-4:** Summary of IEMax elevations above BFE for new buildings in coastal V-zones, by state, for 1 year of new construction.

State	Height above BFE (ft)	Property (\$M)	ALE & indirect BI (\$M)	Insurance (\$M)	Death, injury (\$M)	Benefit (\$M)	Cost (\$M)	BCR
TX	8	2.18	0.64	0.37	0.01	3.20	0.35	9.1
LA	10	1.49	0.41	0.25	0.01	2.16	0.45	4.8
MS	10	2.32	0.67	0.39	0.01	3.40	0.34	10.1
AL	10	0.79	0.22	0.13	0.00	1.15	0.10	11.7
FL	10	23.19	6.55	3.94	0.11	33.80	4.01	8.4
GA	6	1.22	0.34	0.21	0.01	1.77	0.47	3.8
SC	10	0.09	0.02	0.02	0.00	0.13	0.03	5.0
NC	10	1.99	0.56	0.34	0.01	2.90	0.56	5.2
VA	6	0.02	0.00	0.00	0.00	0.02	0.01	3.8
MD	6	0.01	0.00	0.00	0.00	0.01	0.00	3.8
DE	6	0.02	0.01	0.00	0.00	0.02	0.01	3.8
NJ	6	0.04	0.01	0.01	0.00	0.06	0.02	3.8
NY	6	0.09	0.02	0.02	0.00	0.13	0.03	3.8
CT	6	0.34	0.09	0.06	0.00	0.49	0.13	3.8
RI	6	0.36	0.10	0.06	0.00	0.52	0.14	3.8
MA	6	1.09	0.30	0.19	0.01	1.59	0.40	3.9
Total		35.2	9.9	6.0	0.2	51	7	7

## NATURAL HAZARD MITIGATION SAVES:

Regional differences in BCR and the IEMax elevation generally agree with regional differences in coastal hazard maps. As one might expect, there appears to be a lower BCR where the hazard is lower, such as in the northeastern United States. Even so, the BCRs at the IEMax elevation still exceed 3:1, with the IEMax building height 5 feet above code (BFE + 6) from Virginia to Massachusetts. This might have been harder to believe before Superstorm Sandy. Sandy demonstrated that coastal surge damage can be severe, even in places with only moderate to moderately high wind hazard. The analysis shows that storm-surge heights in these areas constitute a significant hazard, and that reducing that hazard by building higher makes financial sense on a benefit-cost basis.

The project team successfully incorporated NOAA Maximum-of-Maximums (MOMs) Envelope of Water (National Oceanic and Atmospheric Administration 2014) into a regional probabilistic estimate of storm surge. It was necessary to do so. Using just flood insurance studies (FIS) and FEMA flood maps, one can estimate hazard at the 1% recurrence rate, but the real hazard is uncertain, so actual flood depth with 0.01 annual exceedance frequency might be higher or lower. Modeling losses with the NOAA MOMs (National Oceanic and Atmospheric Administration 2014), scaled to generally agree with FEMA FIS (Federal Emergency Management Agency 2003, 2006a, b, 2007b, c, 2008c, d, 2009a, b, 2012a, b, c, 2013a, 2014b, c) and flood maps (Federal Emergency Management Agency 2014d), captures some of the epistemic uncertainty, perhaps providing more-realistic and more-robust BCRs, because of the diversity of data and approaches.

The project team successfully incorporated National Oceanic and Atmospheric Administration (2017a) projections of sea level rise (SLR) into the BCA. SLR increases the estimated benefit of building higher above BFE because SLR adds to storm surge, and higher hazard increases the benefit of mitigation. The benefit of this particular mitigation measure only goes so far. When the sea rises, it extends inland. When it reaches the building footprint, the ground below is no longer dry on a daily basis, so greater elevation of the first floor provides no more practical benefit.

Including SLR increases the BCR by about 10% when using the baseline 2.2% cost-of-borrowing discount rate. Using a higher discount rate such as the 3% and 7% discount rates used by the Office of Management and Budget (OMB) reduces the effect of including SLR, because it reduces the recognition of future benefits. The greater the discount rate, the less the model values the future a few decades out, and the less the model recognizes the benefits of greater elevation to mitigate against SLR. Section 2.5 examines sensitivity to SLR and the discount rate.

The costs and benefits estimated in the *Interim Report* exclude location-specific factors—local variations in construction cost that make one place more or less expensive to build or to pay for repairs than another place. Omitting location cost factors probably may slightly affect total dollar costs and total dollar benefits. The effect is probably small compared with other uncertainties in the analysis.

Location cost factors should affect BCR little if at all. Higher up-front construction cost will tend to accompany higher future repair costs. In locations where future repair costs are greater, mitigation produces greater savings. Thus, higher up-front construction costs occur in the same places as higher

future benefits. The two effects cancel out in the BCR, at least for financial costs and benefits, because the same factor would appear in both the numerator and denominator of the BCR. Deaths and injuries are different because they are not affected by location cost factors. The BCR is lower in places where there are higher up-front construction costs and where benefits are dominated by avoided deaths and nonfatal injuries.

Note, finally, that the results presented in the *Interim Report* do not consider social vulnerability, that is, the different degree of harm caused by natural disasters to people who are less able to recover from the disaster owing to lower income, age, etc.

### 2.2.3. Designing to Exceed 2015 I-Code Requirements for Hurricane Wind

If all new homes were built to the IEMax IBHS FORTIFIED Home program level for 1 year, it would cost approximately \$720 million extra and would produce approximately \$3.8 billion in avoided future losses. The aggregate BCR (summing benefits and costs over all states) is approximately 5:1, e.g., \$5 saved for every \$1 spent to build new buildings better along the Gulf and Atlantic Coasts.

Compliance with the IBHS FORTIFIED Home Hurricane program appears to be cost effective everywhere along the Atlantic and Gulf Coasts. As discussed in further depth in Section 4.11.3, the analysis estimates BCR by 10-mph wind speed band, that is, in geographic bands that share a common value with the wind speed in the American Society of Civil Engineers (ASCE) Structural Engineering Institute (SEI) standard ASCE 7-16 (American Society of Civil Engineers Structural Engineering Institute 2017) *Minimum Design Loads and Associated Criteria for Buildings and Other Structures* with 700-year mean recurrence interval (MRI).

Note that the analysis uses 2015 I-Code design requirements (which use ASCE 7-10 wind maps for design) to establish the vulnerability of the buildings, whereas ASCE 7-16 wind maps are used to describe the relationship between the frequency and severity of winds that will affect the buildings in the future. The former sets the design; the other characterizes the hazard.

The project team considered more than the 700-year wind speed when calculating the wind hazard. Rather, the team attributed the same wind hazard to all locations that share a common value of 700-year wind speed. That is, the analysis considered wind speeds with more-frequent and more-rare recurrence; these contribute to the estimated benefits as well. The following results present estimates of the benefits and costs of 1 year of new construction to exceed 2015 I-Code requirements. (In 1 year, the United States adds or replaces about 1 square foot of buildings for every 100 square feet already in existence, so the costs and benefits of replacing all existing buildings can be calculated by multiplying by 0.01 to reflect 1 year of new construction.)

Table 2-5 presents the IEMax IBHS FORTIFIED Home Hurricane option for each wind speed band. Note that, although hurricane winds are defined as exceeding 115 mph, even buildings built in locations with lower design wind speed can experience higher actual winds, albeit with lower probability. Thus, buildings

## NATURAL HAZARD MITIGATION SAVES:

in the 110 mph design wind speed band can experience hurricane-force winds and can benefit from IBHS FORTIFIED standards.

Figure 2-7 illustrates the BCR on a map. The BCR varies from a maximum of 26 for IBHS FORTIFIED Home Hurricane Silver (in locations where 700-year wind speed is 180 mph) to 1.5 for IBHS FORTIFIED Home Hurricane Silver (in locations with 130 mph 700-year wind speed). The IEMax level of certification by location is provided in Figure 2-8. The BCR exceeds 10 where the 700-year wind speed is equal to or greater than 160 mph. These areas, in south Florida and small areas of the Louisiana and Alabama coasts, account for approximately 5% of the population within the scope of the Interim Study. They may be subject to stricter requirements in a local code (e.g. Florida's Miami-Dade and Broward Counties), but the Interim Study does not consider local codes.

The results show that in places where 700-year wind speed is less than 130 mph, the IBHS FORTIFIED Bronze level is a particularly cost-effective solution to hurricane hazard mitigation, with BCRs from 5.6 to 7.9. In these lower hazard areas, the relative cost of more nails and the use of ring-shank nails are modest compared to the benefits. These simpler measures are required by the 2015 IRC at higher design wind speeds, so at higher wind speeds they do not exceed code requirements, and do not count toward costs and benefits for this piece of the Interim Study.

At design wind speeds greater than 130 mph, FORTIFIED Silver appears to be the most cost-effective option. FORTIFIED Silver calls for protecting openings. FORTIFIED Gold is not applicable in many cases, and is not the IEMax FORTIFIED program for any of the wind bands examined. It is not considered cost effective at lower levels of design wind speed. However, individual owners may prefer to use Gold for other reasons than achieving a BCR.

The reason the BCR at 120-mph 700-year wind speed is so much higher than at 130 mph is that IBHS FORTIFIED Home Hurricane Bronze requires closer nail spacing for roof-deck attachment at 120 mph than does the IRC: 8d ring-shank nails at 6"/6" (IBHS FORTIFIED Home Hurricane Bronze) as opposed to 8d smooth-shank nails at 6"/12" (2015 IRC). The cost is small and the benefit is large. At a 700-year wind speed of 130 mph, the 2015 IRC requires the closer nailing, so it incorporates the mitigation into the code and there is less for IBHS FORTIFIED Home Hurricane to do.

Figure 2-9 illustrates the contributions from the various benefit categories: first, ALE and indirect BI (45%), followed by building and contents repair costs (39%), and insurance (16%). As outlined in Section 4.17, the insurance benefit results solely from reduced overhead and profit (O&P) costs, not from reduced property losses. O&P is estimated to add 30% to the pure premium associated with property losses. Reducing property losses by \$1.00 on an expected annualized basis should decrease O&P charges by \$0.30, in the long term, on an aggregate geographic basis. The \$0.30 figure is based on an average between 2006 and 2015 of incurred losses and-loss adjustment expenses as a percent of earned premiums, according to the Insurance Information Institute (2015).



## NATURAL HAZARD MITIGATION SAVES:

**Table 2-5:** Benefits and costs for 1 year of new construction at IEMax IBHS FORTIFIED Home Hurricane levels (millions).

700-year wind speed (mph)	IEMax FORTIFIED program	Building and contents	Living expenses & indirect BI	Insurance	Benefit	Cost	BCR
110	Bronze	\$ 344	\$ 373	\$ 144	\$ 861	\$ 154	5.6
115	Bronze	\$ 180	\$ 196	\$ 75	\$ 452	\$ 81	5.6
120	Bronze	\$ 168	\$ 182	\$ 70	\$ 420	\$ 53	7.9
130 (> 1 mi)	Silver	\$ 64	\$ 69	\$ 27	\$ 159	\$ 106	1.5
130 (≤ 1 mi)	Silver	\$ 8	\$ 8	\$ 3	\$ 19	\$ 13	1.5
140	Silver	\$ 146	\$ 158	\$ 61	\$ 365	\$ 150	2.4
145	Silver	\$ 0	\$ 0	\$ 0	\$ 0	\$ 0	3.2
150	Silver	\$ 61	\$ 109	\$ 42	\$ 211	\$ 47	4.5
160	Silver	\$ 519	\$ 564	\$ 217	\$ 1,300	\$ 118	11.1
170	Silver	\$ 11	\$ 12	\$ 5	\$ 29	\$ 2	14.9
180	Silver	\$ 4	\$ 5	\$ 2	\$ 11	\$ 0	26.6
Total	Mixed	\$ 1,505	\$ 1,676	\$ 646	\$ 3,827	\$ 724	5

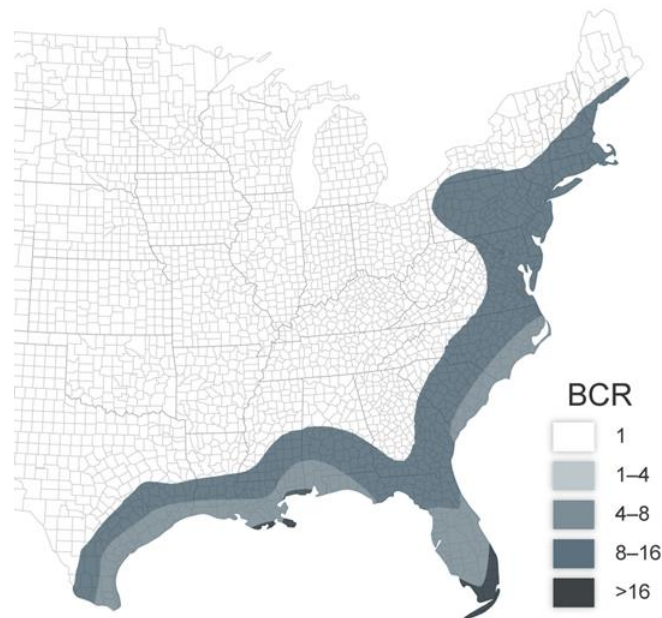

**Figure 2-7:** BCR of hurricane wind mitigation by building new homes under the FORTIFIED Home Hurricane Program (by wind band).

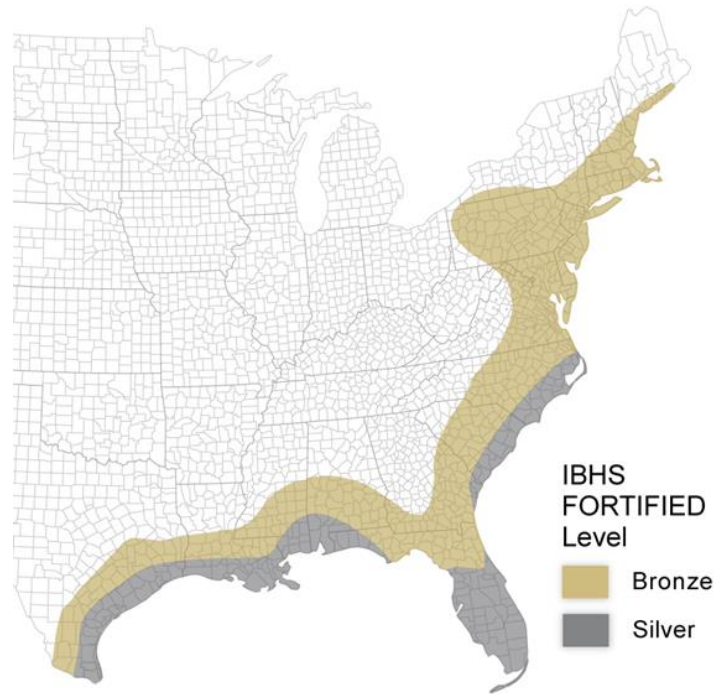

Figure 2-8: Maximum level of the IBHS FORTIFIED Home Hurricane design for new construction where the incremental benefit remains cost effective.

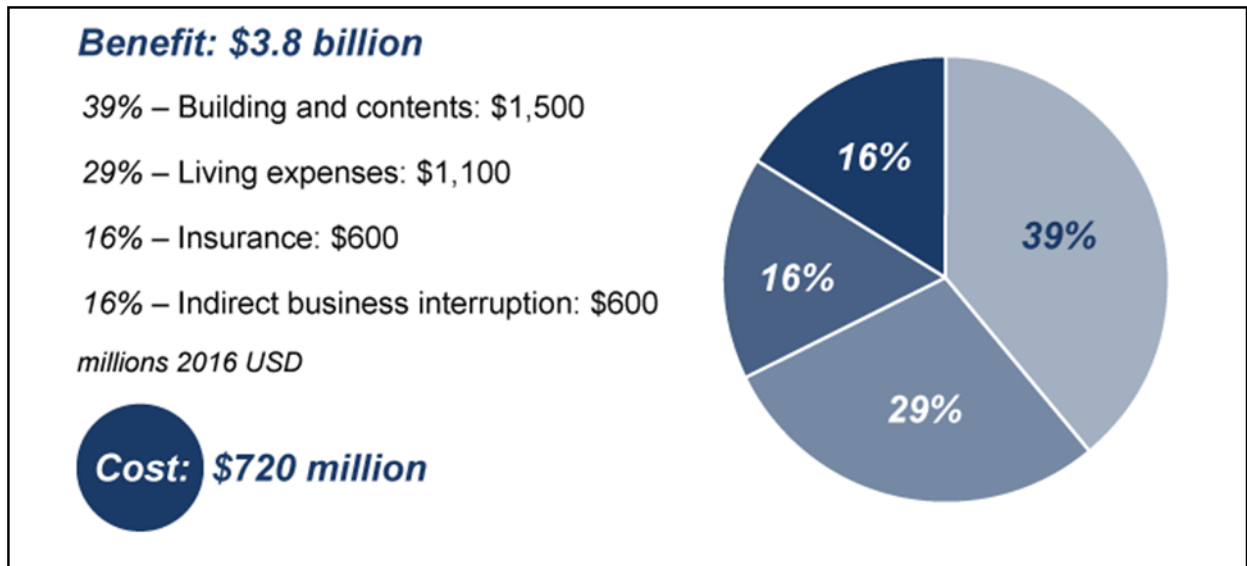

Figure 2-9: Benefits and costs for 1 year of new construction at the IEMax IBHS FORTIFIED Home Hurricane levels.

## NATURAL HAZARD MITIGATION SAVES:

If all new commercial structures were built to the IEMax IBHS FORTIFIED Commercial program level for 1 year, it would cost approximately \$91 million more but would produce approximately \$392 million in avoided future losses. The aggregate BCR (summing benefits and costs over all states) is approximately 4:1, e.g., \$4 saved for every \$1 spent to build new commercial buildings better along the Gulf and Atlantic Coasts.

Similar to the IBHS FORTIFIED Home Program, compliance with the IBHS FORTIFIED Commercial Hurricane program is cost-effective in all hurricane prone regions, located along the Atlantic and Gulf Coasts. Table 2-6 presents the IEMax IBHS FORTIFIED Commercial Hurricane option for each wind speed band. Figure 2-7 illustrates the BCR on a map. The BCR varies from a maximum of 14:1 for IBHS FORTIFIED Commercial Hurricane Silver (in locations where 700-year wind speed is 180 mph) to 2:1 for IBHS FORTIFIED Commercial Hurricane Silver (in locations with 700-year wind speed between 115 and 120 mph). The IEMax level of certification by location is provided in Figure 2-8. The BCR exceeds 10 where the 700-year wind speed is equal to or greater than 170 mph. These areas, located at the southern tip of Florida, account for less than 1% of the building stock within the scope of the Interim Study. As with the IBHS FORTIFIED Home analysis, they may already be subject to stricter requirements in a local code, but the present Interim Study does not consider local codes.

The results show a BCR of 2:1 at the outer edge of the ASCE 7-16 hurricane prone regions (where the 700-year wind speed is greater than 115 mph). At this location, the IEMax FORTIFIED Commercial Hurricane Silver program requires builders and designers to adhere to the FORTIFIED Commercial Hurricane Bronze requirements, which include the stronger design of roof-related components and connections, as well as the FORTIFIED Commercial Hurricane Silver requirements, which include strengthened building envelope protection and continuity of business operations (via installation of a transfer switch to support backup power).

As evident in Table 2-6, the BCR steadily increases until the 700-year wind speed is equal to 130 mph, and the commercial property is further than 1 mile from the coast. A dip in the BCR (from 7:1 to 2.4:1) occurs in locations where the 700-year wind speed is equal to 130 mph, and the property is located less than 1 mile from the coast. The reason for this drop is primarily triggered by the mandatory code requirements in windborne debris regions. These are areas located within 1 mile of the coast and where the basic design wind speed is 130 mph or greater, or in areas where the basic design wind speed is 140 mph or greater. The added benefits (and associated costs) of opening protection via the IBHS FORTIFIED Commercial Hurricane Silver program are no longer applicable, as the current code already requires this level of mitigation. New construction following the IBHS FORTIFIED Commercial Hurricane Silver program, however, still accrues the benefits due to a reduction in downtime as a result of how prepared the are to switch to backup power.

Although the IBHS FORTIFIED Commercial Hurricane Silver program is considered the IEMax BCR for all wind contours analyzed, both the IBHS FORTIFIED Commercial Hurricane Bronze and Gold programs are still considered cost effective mitigation options for above-code design. The aggregate BCRs for IBHS

## NATURAL HAZARD MITIGATION SAVES:

FORTIFIED Commercial Hurricane Bronze and Gold are approximately 6:1 and 2:1, respectively. IBHS FORTIFIED Commercial Hurricane Bronze is cost effective in all hurricane prone regions (that is, where 700-year wind speed is greater than 115 mph) because it reduces damage through its higher design pressure requirements. IBHS FORTIFIED Commercial Hurricane Gold is particularly effective in regions of higher basic wind speeds (140 mph or greater) because it requires backup power and helps to maintain vital business operations. Although IBHS FORTIFIED Commercial Hurricane Gold may not be considered cost effective at lower levels of design wind speeds, individual owners may prefer to use it for other reasons than achieving a BCR. Figure 2-9 illustrates the contributions from the various benefit categories.

**Table 2-6:** Benefits and costs for 1 year of new construction at the IEMax IBHS FORTIFIED Commercial Hurricane levels.

700-year wind speed (mph)	IEMax FORTIFIED program	Building and Contents	Direct / Indirect BI	Insurance	Benefit	Cost	BCR
>115	Silver	\$ 27	\$ 19	\$ 12	\$ 58	\$ 27	2.1
120	Silver	\$ 34	\$ 23	\$ 14	\$ 72	\$ 22	3.3
130 (> 1 mi)	Silver	\$ 68	\$ 44	\$ 28	\$ 140	\$ 20	7.0
130 (≤1 mi)	Silver	\$ 1	\$ 1	\$ 0	\$ 1	\$ 1	2.4
140	Silver	\$ 13	\$ 17	\$ 5	\$ 35	\$ 10	3.5
150	Silver	\$ 7	\$ 9	\$ 3	\$ 19	\$ 3	5.7
160	Silver	\$ 23	\$ 32	\$ 10	\$ 64	\$ 7	8.8
170	Silver	\$ 1	\$ 1	\$ 0	\$ 2	\$ 0	10.2
180	Silver	\$ 0	\$ 0	\$ 0	\$ 1	\$ 0	14.4
Total	Silver	\$ 173	\$ 146	\$ 73	\$ 392	\$ 91	4

**NATURAL HAZARD MITIGATION SAVES:**

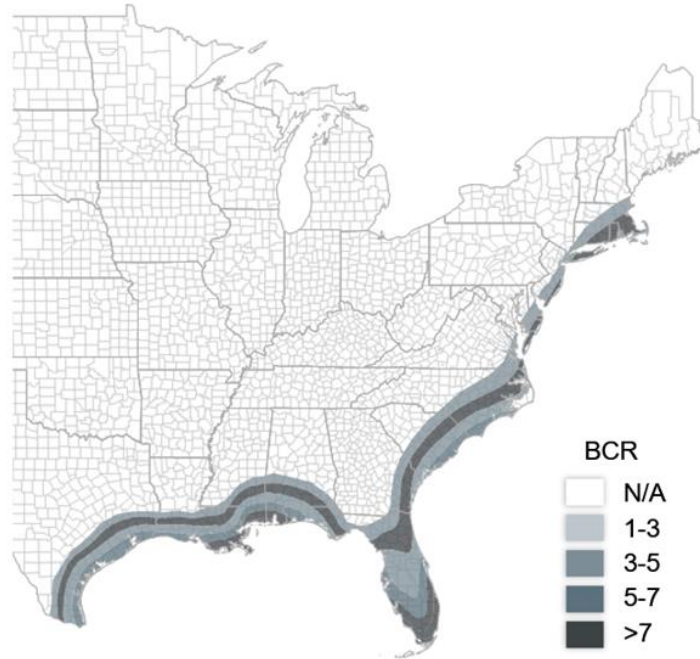

Figure 2-10: BCR of hurricane wind mitigation by building new homes under the FORTIFIED Commercial Program (by wind band).

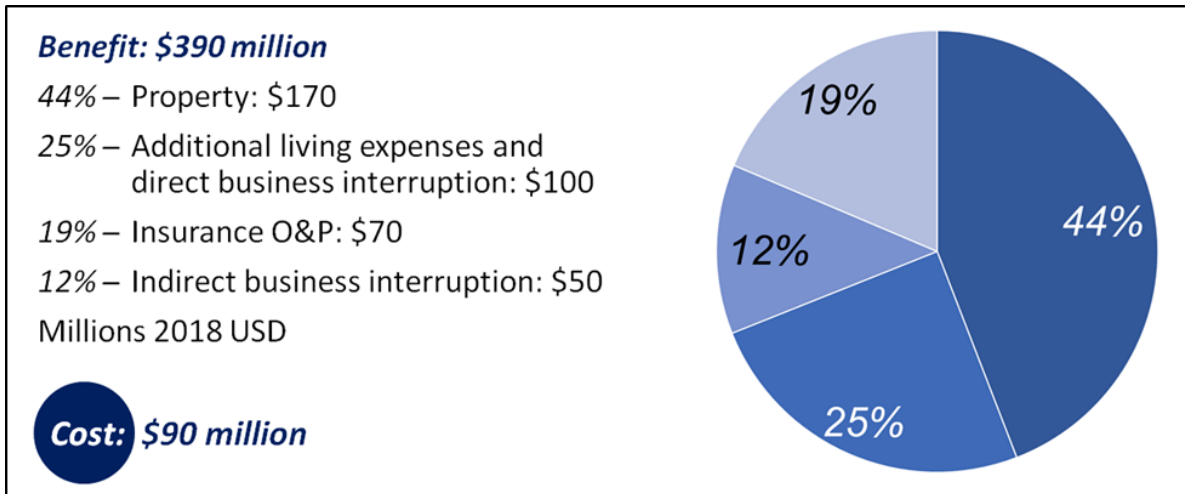

Figure 2-11: Benefits and costs for 1 year of new construction at the IEMax IBHS FORTIFIED Commercial Hurricane levels.

The combined cost and benefit breakdowns for both the IBHS FORTIFIED Home and Commercial Hurricane programs can be found in Table 2-7. Benefits and costs of residential structures account for approximately 91% and 89%, respectively, of the total. As such, the BCRs are heavily weighted by the IBHS FORTIFIED Home program, and only slightly decrease from those values found in Table 2-5. Aggregating the results from both studies, if all new commercial and residential structures were built to the IEMax IBHS

## NATURAL HAZARD MITIGATION SAVES:

FORTIFIED program level for 1 year, it would cost approximately \$810 million extra and would produce approximately \$4.2 billion in avoided future losses. The aggregate BCR (summing benefits and costs over all states) is approximately 5:1, e.g., \$5 saved for every \$1 spent to build new commercial buildings better along the Gulf and Atlantic Coasts. Figure 2-12 illustrates how the benefit categories contribute to total benefit from building new coastal buildings for one year to the IEMax level of IBHS FORTIFIED Home Hurricane and IBHS FORTIFIED Commercial Hurricane standard.

**Table 2-7:** Benefits and costs for 1 year of new construction at the IEMax IBHS FORTIFIED Home Hurricane and IEMax IBHS FORTIFIED Commercial Hurricane levels.

700-year wind speed (mph)	Building & contents (\$ million)	ALE, direct & indirect BI (\$ million)	Insurance O&P (\$ million)	Benefit (\$ million)	Cost (\$ million)	BCR
110	\$ 344	\$ 373	\$ 144	\$ 861	\$ 154	5.6
115	\$ 208	\$ 215	\$ 87	\$ 510	\$ 109	4.7
120	\$ 202	\$ 206	\$ 85	\$ 493	\$ 75	6.5
130 (>1 mi)	\$ 131	\$ 113	\$ 55	\$ 299	\$ 126	2.4
130 (<1 mi)	\$ 8	\$ 9	\$ 3	\$ 21	\$ 12	1.7
140	\$ 158	\$ 175	\$ 66	\$ 400	\$ 160	2.5
150	\$ 67	\$ 118	\$ 45	\$ 230	\$ 50	4.6
160	\$ 542	\$ 595	\$ 227	\$1,364	\$ 125	11
170	\$ 12	\$ 13	\$ 5	\$ 30	\$ 2	15
180	\$ 5	\$ 5	\$ 2	\$ 12	\$ 0.5	25
Total	\$ 1,678	\$ 1,822	\$ 719	\$4,219	\$ 814	5

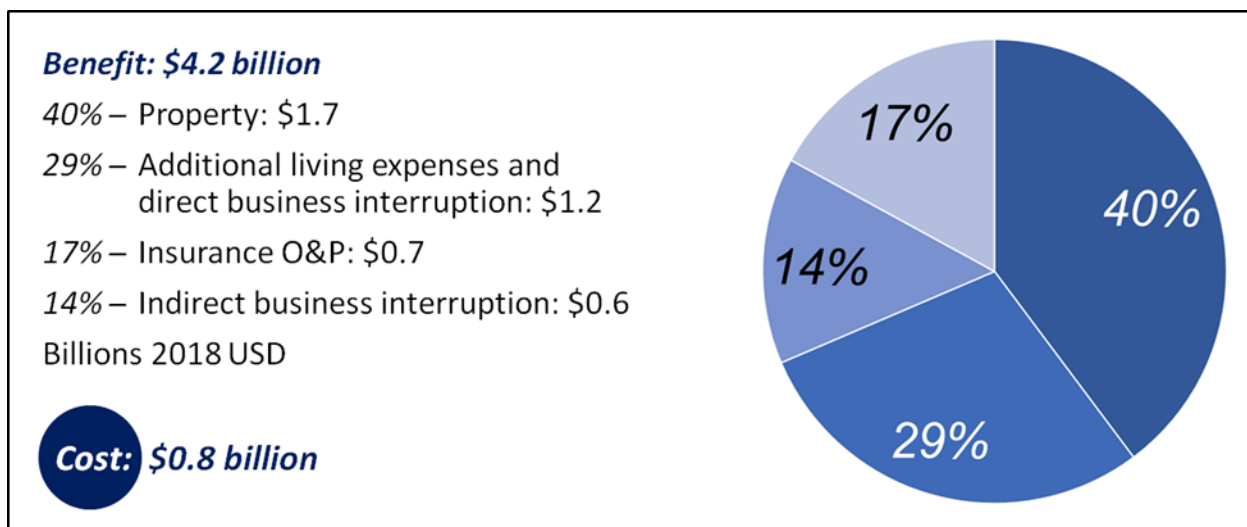

Figure 2-12: Benefits and costs for 1 year of new construction at the IEMax IBHS FORTIFIED Commercial Hurricane and IEMax IBHS FORTIFIED Home Hurricane levels.

#### 2.2.4. Designing to Exceed 2015 I-Code Requirements for Earthquake

This section presents the benefits and costs of designing new buildings with strength and stiffness that exceeds the minimum earthquake design requirements of the 2015 IBC. The IEMax strength and stiffness to exceed 2015 I-Code requirements varies from county to county, as does the county-level cost and benefit. In some counties, designing to exceed 2015 I-Code requirements appears to be cost effective on a BCR basis, in others it does not. Considering just those counties where designing to exceed 2015 I-Code requirements has a county-level BCR greater than 1.0, if all new buildings in all of those counties were built to their county's IEMax level for 1 year, the costs would total approximately \$1.2 billion. The sum of the benefits totals approximately \$4.3 billion. Dividing the aggregate benefit by the aggregate cost produces an overall average BCR of approximately 4:1, e.g., an average of \$4 saved for every \$1 spent to build new buildings stronger and stiffer.

Figure 2-13 details the distribution of the benefits that would accrue from 1 year of new construction to the IEMax  $I_e$  (the increase in strength and stiffness as a minimum design base shear and minimum design stiffness) value.<sup>12</sup> Approximately half (47%, or \$2 billion) accrue from reduced BI (including ALE). About 35% (\$1.5 billion) come from reduced property damage. Most of the remainder (18%, \$800 million) comes from the U.S. government's acceptable cost to avoid statistical deaths, nonfatal injuries, and PTSD. A small fraction (1%, \$30 million) comes from reduced future costs of urban search and rescue. (The project team did not calculate urban search and rescue costs in the BCR for exceeding 2015 I-Code requirements for flood or wind because of its very minor contribution to benefits.)

<sup>12</sup> The IBC does not define a quantity called minimum design stiffness per se, but rather specifies maximum allowable deformation, which is inversely related to stiffness. The IBC also uses the term  $I_e$  differently than the interim study does: as a multiplier for strength but not for stiffness. It is used here as a multiplier for both strength and stiffness.

## NATURAL HAZARD MITIGATION SAVES:

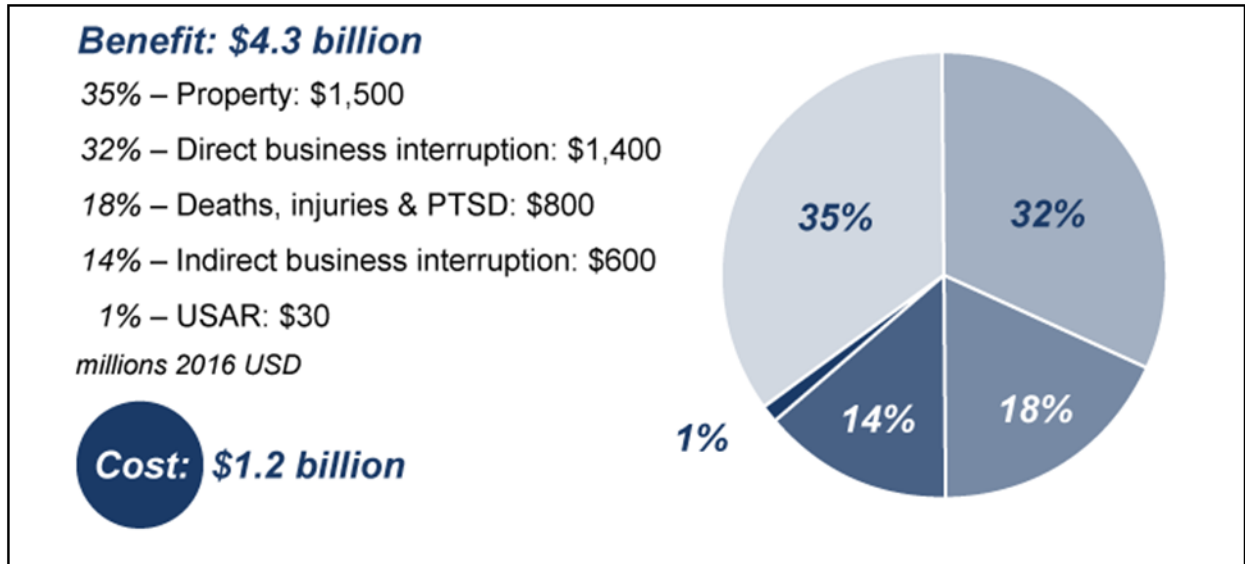

Figure 2-13: Contribution to benefits from exceeding 2015 I-Code earthquake requirements.



### Box 2-2. Why Calculate Benefits and Costs Up to $I_e = 8$ ?

Some critics may object to evaluating benefits and costs for  $I_e$  values as high as 8, and question whether it is even possible to design to such high strengths. It seems possible in many circumstances.

Consider a new 2-story office building in which the seismic force-resisting system relies on special reinforced masonry shearwalls, to use the terminology of ASCE 7-10 Table 12.2-1 (ASCE/SEI 2010). If the building were built in Petaluma, California, at 38.232N -122.615E, on soil of site class D, and it just met strength and stiffness requirements of ASCE 7-10, it would have a seismic response coefficient (design base shear as a fraction of building weight) of  $C_s = 0.23$ . Picking up that building and moving it to a certain location in Denver, Colorado, would change its minimum required  $C_s$  to be 0.0282g. Since it actually has  $C_s = 0.23$ g, it would satisfy design requirements for  $I_e = 0.23/0.0282 = 8.0$ . Therefore, engineers could design a new building in Denver to be 8 times as strong and stiff as the 2015 IBC requires.

Furthermore, one could build the Petaluma building 8 times as strong as the 2015 IBC requires for its actual California location. It could be built with less than 200 linear feet in each direction of 8-inch concrete masonry unit walls with 4 ksi masonry and grout and one 60-ksi number-8 bar in each cell. It really is practical (though probably not cost effective) to design many buildings to remain essentially elastic even at design-level shaking.

It probably does not make sense to design an office building with  $I_e = 8.0$  on the basis of a BCR, but it is possible. Designing for site-specific seismic hazard uses risk-adjusted maximum considered earthquake ( $MCE_R$ ) ground motion maps where spectral acceleration response factor ( $S_S$  and  $S_1$ ) values span almost two orders of magnitude, meaning that the minimum seismic strength in the most highly seismic places are approximately 80 times those of the lowest-hazard places ( $S_S = 3.06$ g near Ridgley, Tennessee, versus 0.037g near Langdon, North Dakota). A factor of 8 is modest compared with the 80-times range of values in design maps.

Note, some architectural designs are not achievable in very highly seismic areas at very high values of  $I_e$  or using certain structural materials. Near the high end of the design maps, it may not be practical to design much stronger. But common cases can be designed to  $I_e$  up to at least 3.0, which, as shown later, appears to be approximately the highest value anywhere in the 48 contiguous United States that makes sense on the basis of BCR.

When  $I_e = 1.0$ , the design just meets the minimum strength and stiffness requirements of the 2015 IBC. A value of  $I_e = 3.0$  means the building is at least 3 times as strong and stiff as the 2015 IBC requires, and experiences no more than  $1/3^{\text{rd}}$  the deformation as the code allows. The project team evaluated benefits

## NATURAL HAZARD MITIGATION SAVES:

and costs for  $I_e$  values of 1.0, 1.25, 1.5, 2, 3, 4, 5, 6, 7, and 8. (To understand why so high, see Box 2-2.) The project team also calculated the incremental cost  $\Delta C$  and incremental benefit  $\Delta B$  of increasing  $I_e$  from 1.0 to 1.25, 1.25 to 1.5, 1.5 to 2.0, etc. The project team calculated the IEMax value of  $I_e$  on a census-tract basis; “IEMax” here means the largest value of  $I_e$  where  $\Delta B/\Delta C > 1.0$ , e.g., the largest incremental investment in designing to exceed 2015 I-Code requirements that still produces benefits in excess of costs.

The IEMax  $I_e$  for approximately 2,700 counties (from a BCR perspective) is 1.0, e.g., the current code minimum. For approximately 400 counties, however, designing to exceed 2015 I-Code earthquake requirements appears to be cost effective at the cost-of-borrowing discount rate of approximately 2.2%. Figure 2-14 presents the estimated BCR if all new buildings in the county were designed to the county-level IEMax value of  $I_e$ . Figure 2-15 shows each county’s IEMax  $I_e$ . Table 2-8 lists counties with the 10 highest county-level BCRs, all of which are in California. All but San Benito County have a county-level IEMax  $I_e$  of 2.0; San Benito County, with a 2010 population of about 100,000 people, has an IEMax  $I_e$  value of 3.0.

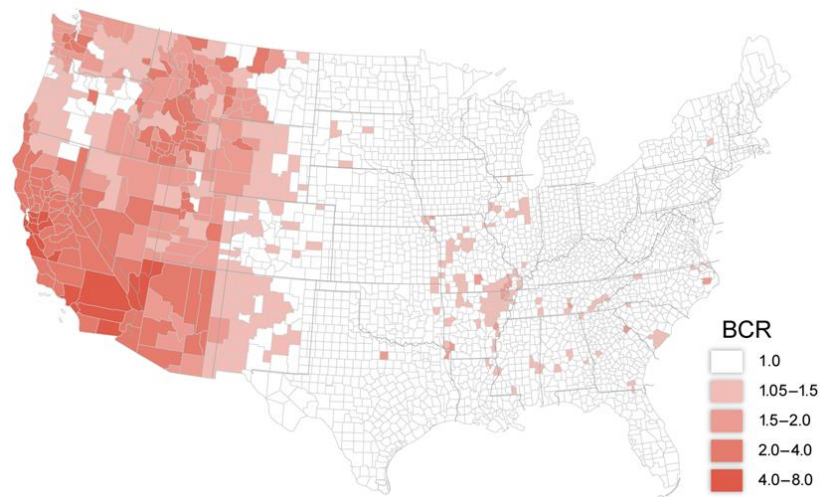

**Figure 2-14:** BCR of earthquake mitigation by increasing strength and stiffness in new buildings (by county).

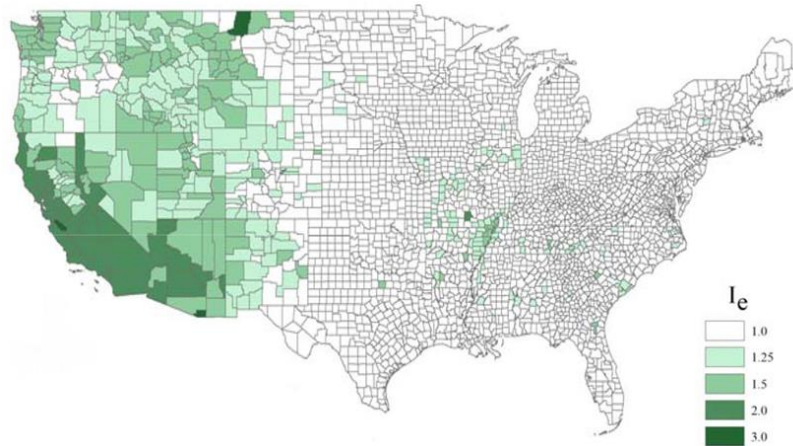

Figure 2-15 : Maximum strength and stiffness factor  $I_e$  to exceed 2015 IBC and IRC seismic design requirements where the incremental benefit remains cost effective.

Table 2-8: Top-10 counties for designing to exceed 2015 I-Code earthquake requirements.

County	State	County-level IEMax $I_e$	County-level BCR
Imperial	CA	2	7.4
Santa Clara	CA	2	6.0
Monterey	CA	2	5.1
San Bernardino	CA	2	5.0
Alameda	CA	2	4.9
San Joaquin	CA	2	4.7
Los Angeles	CA	2	4.7
San Benito	CA	3	4.7
Riverside	CA	2	4.6
Santa Cruz	CA	2	4.6

Table 2-9 summarizes the number of people that benefit from designing new buildings to exceed I-Code minimum strength and stiffness with each of the values of IEMax  $I_e$ . Figure 2-16 illustrates the same information. Approximately 100,000 people live in counties where designing to three times the minimum strength and stiffness makes economic sense. Approximately 40 million people, 13% of the 2010 population of the United States, live in counties where the IEMax  $I_e$  is twice the code minimum. Another 30 million people—10% of the U.S. population—live where it would be cost effective to design to 25% or 50% greater than code-minimum strength and stiffness. The current code makes economic sense on a benefit-cost basis for about three-quarters of the U.S. population.

Table 2-9: Population distribution by county-level IEMax  $I_e$ .

IEMax $I_e$	Counties	2010 population	% of total
1.0	2,674	236,009,947	77%
1.25	253	16,755,955	5%
1.5	126	14,033,579	5%
2	51	39,909,835	13%
3	3	106,942	0.03%
4+	0	0	0%

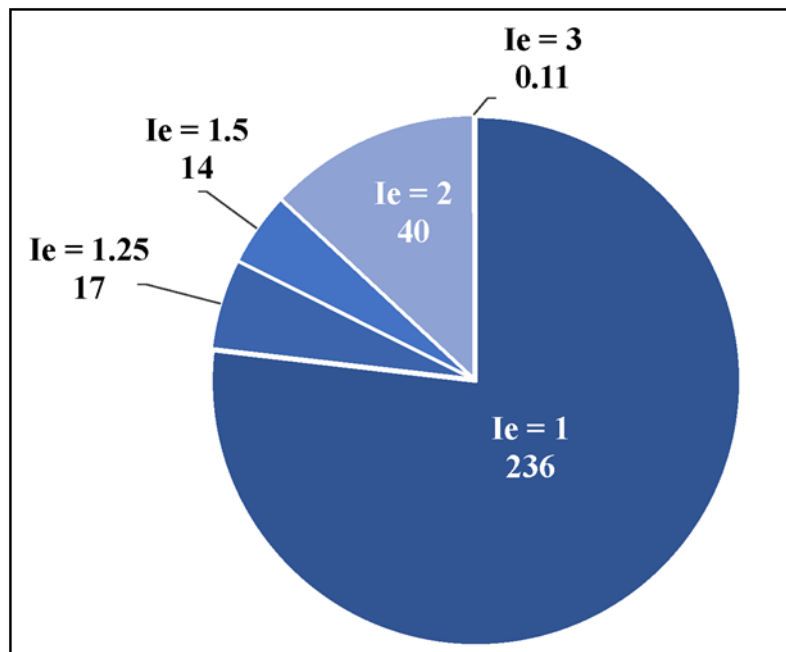

Figure 2-16: Population (millions) by county-level IEMax  $I_e$ .

**Evaluating Reasonableness of the Results.** The results of the *Interim Report* generally agree with intuition. First, the *2005 Mitigation Saves* study found a BCR on the order of 1.5 for earthquake retrofits. It makes sense that incorporating mitigation into new buildings would produce a higher BCR. One might have expected an even larger BCR; an order of magnitude might have seemed reasonable. Perhaps the fact that the BCR is only 4:1 rather than 15:1 can be explained by the fact that new buildings are already strong.

Second, it makes sense that almost half of the mitigation benefit comes from reduced BI, since prior studies such as the ShakeOut scenario (e.g., Jones et al. 2008, pg. 280) suggested that BI losses in a large earthquake can contribute half of the total loss.

## NATURAL HAZARD MITIGATION SAVES:

Third, it makes sense that BI losses are larger than property losses, since the building code aims to control damage to a limited extent but does not explicitly aim to ensure post-earthquake operability.

Fourth, it makes sense that BCR is higher in California and near large active faults. Greater seismicity means greater chance of incurring, and therefore avoiding, losses. Research for the CUREE-Caltech Woodframe Project (Porter et al. 2006) found similar results for seismic retrofit of older woodframe buildings.

### 2.2.5. Complying with 2015 IWUIC

If all new buildings built in 1 year in census blocks with BCR > 1 complied with the 2015 IWUIC, compliance would add about \$800 million to total construction cost for that year. The present value of benefits would total approximately \$3.0 billion, suggesting a BCR of approximately 4:1, e.g., \$4 saved for every \$1 of additional construction and maintenance cost.

As shown in Figure 2-17, the benefits accrue mostly from reduced property loss (\$2.1 billion, 70% of the total), followed by reduced insurance O&P costs (\$600 million, 20%), deaths, nonfatal injuries, and PTSD (\$150 million, 5% of the total), living expenses and sheltering (\$100 million, 3%), and indirect BI (\$50 million, 2%).

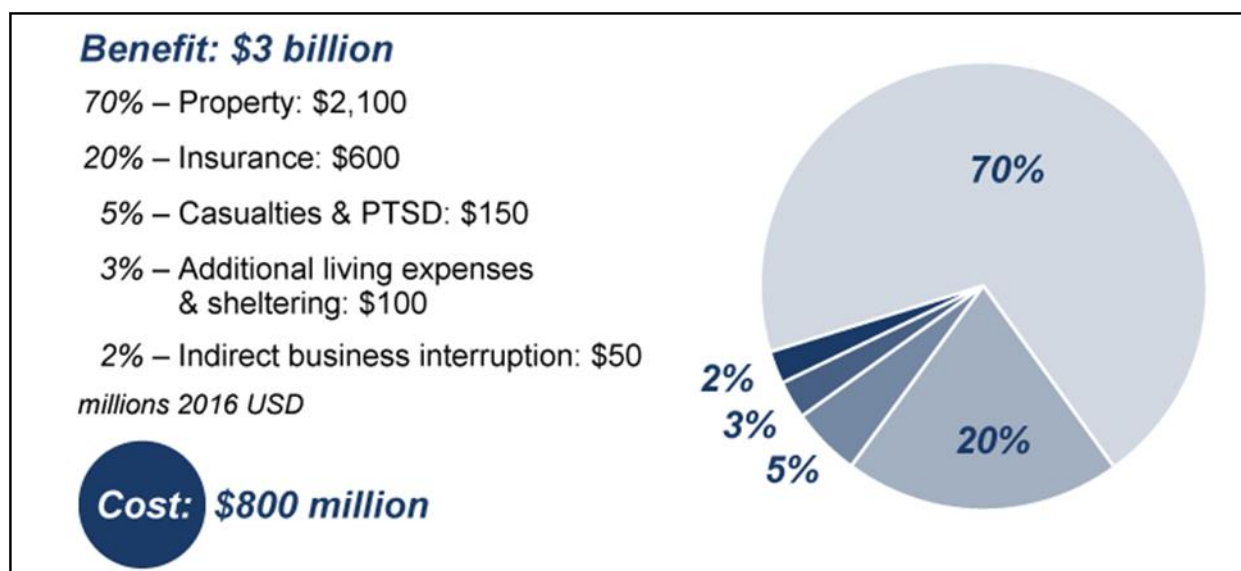

Figure 2-17: Contribution to benefits from 1 year of compliance with the 2015 IWUIC where it is cost effective to do so.

The project team calculated the costs and benefits of complying with the 2015 IWUIC for 47,870 census blocks in four counties in three states: Atlantic County, New Jersey; Alameda County, California; Los Angeles County, California; and Ada County, Idaho. The project team chose these counties to represent a range of fire risk, from moderate (Atlantic County) to high (Alameda and Los Angeles Counties), to extreme (Ada County), based on their burn probabilities (BPs).

## NATURAL HAZARD MITIGATION SAVES:

The resulting BCR only exceeds 1.0 where the fire risk is moderate or higher. Of the 47,870 census blocks, about 10,000 of them (21%) have a BCR greater than 1.0. Approximately 10.5% have a BCR > 2.6. About 2% have a BCR > 8, and the highest BCR is 15.3.

The project team was interested in examining the total nationwide cost and benefit if the 2015 IWUIC was applied everywhere it was cost effective. The team performed a linear regression of BCR (the dependent variable) against BP (the independent variable), for every grid cell in which BCR > 1. The regression analysis showed some scatter but exhibited a relatively high coefficient of determination  $R^2 = 0.85$ . Double-checking the regression, the project team found that it reasonably back-estimated the BCR for the four counties. Since BP is available for the entire contiguous United States, the project team used the results of the regression analysis to estimate BCR for every grid cell in all 3,188 counties of the contiguous United States.

Just as only some census blocks have BCR greater than 1, in general, a county can have no place with BCR > 1, or only parts of the county have BCR > 1. Figure 2-18 shows the county-maximum BCR for every county in the contiguous United States. That is, if a county is shaded other than white in Figure 2-18, there is at least one census block where it would be cost effective on a BCR basis to implement the 2015 IWUIC, and residents and county officials could reasonably consider implementing the code. In the counties that are not shaded, it might still make sense to implement the 2015 IWUIC, although not on a BCR basis. Figure 2-18 shows that 761 counties of the 48 states (24% of counties) and 33 of the states (69% of states) have at least a portion with BCR > 1.

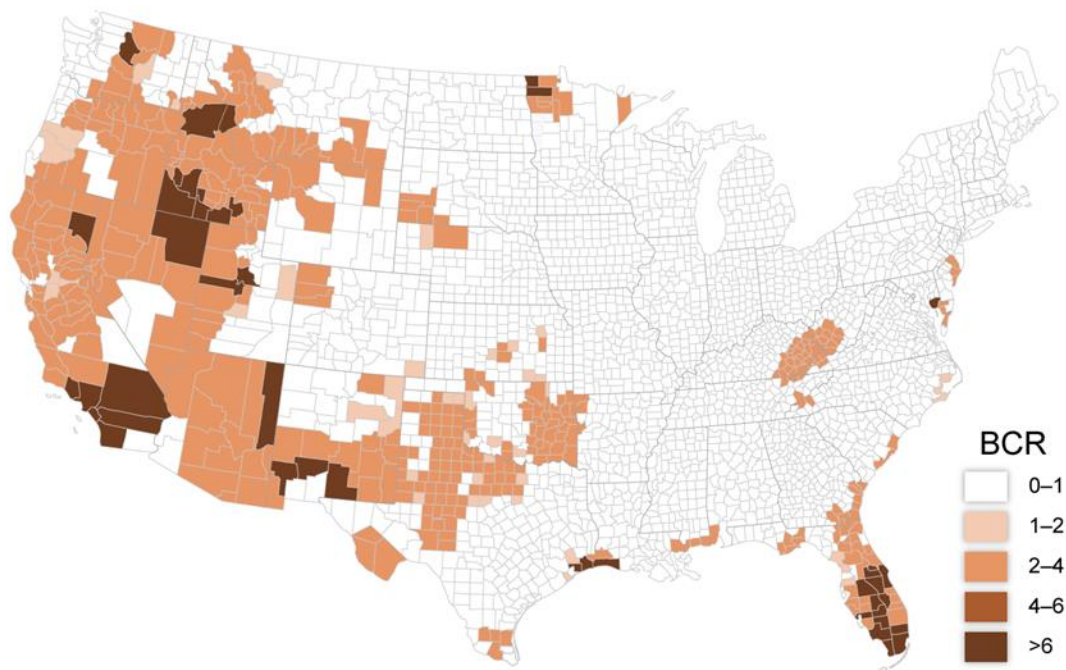

**Figure 2-18:** BCR of WUI fire mitigation by implementing the 2015 IWUIC for new buildings (by county).

### 2.2.6. Incentivization

The foregoing estimates of benefits and costs of designing to exceed 2015 I-Code requirements are offered solely to inform mitigation decisions about new buildings, not to advocate for any choice of code. Benefits, costs, and the BCR represent only a part of the information a decision-maker must consider when deciding among mitigation decisions. Other considerations include resource limitations, recent experience with disasters, community interest, and potentially many other issues. These considerations will vary between communities and individual decision-makers, who must identify, assess, and weigh them based on their own situation.

Not everyone is willing or able to bear the up-front construction costs for more-resilient buildings, even if the long-term benefits exceed the up-front costs. Different stakeholders enjoy different parts of the costs and benefits, and the people who bear more of the costs may argue more urgently than the people who enjoy more of the benefits. However, one set of stakeholders may be able to offer incentives to others to decrease the cost or increase the benefit, and better align the competing interests of different groups.

The MMC and the Institute’s Council on Finance, Insurance and Real Estate (CFIRE) have proposed a holistic approach to incentives that can drive coordinated mitigation investments, aligning the interests of multiple stakeholder groups so that they all benefit from a cooperative approach to natural-hazard mitigation (Multihazard Mitigation Council and Council on Finance, Insurance, and Real Estate 2015). Table 2-10 summarizes many such incentives, many of which apply equally to the adoption of 2018 I-Codes. It shows, by stakeholder group, incentives that the group can enjoy or offer to others to make mitigation more beneficial or less onerous.

**Table 2-10:** Incentives to implement designing to exceed 2015 I-Code requirements for typical (Risk Category II) buildings.

Stakeholder	Decision-maker	Incentives	Special costs and benefits
Homeowner	Mortgagor	Reduced insurance premium, tax deduction	Reduced repair costs, reduced chance of mortgage default, accelerated recovery and reduced recovery costs. Some homeowners may be more financially marginal and might be less able to pay extra costs. As a result, the most socially vulnerable people could end up occupying the most structurally vulnerable homes.
Building owner	Corporate real estate manager	Reduced insurance premium, second and later building owners might pay more for resilient buildings, especially if renters would.	Reduced repair costs, reduced chance of mortgage default, accelerated recovery and reduced recovery costs, competitive advantage if others suffer damage.

## NATURAL HAZARD MITIGATION SAVES:

Stakeholder	Decision-maker	Incentives	Special costs and benefits
Occupant	Residential tenant, corporate tenant's chief financial officer or corporate real estate manager, city manager		Enhanced life safety, reduced BI losses, possibly increased content losses. Renters may be more financially marginal. Only higher-income renters would be able to pay these extra costs. As a result, the most socially vulnerable people could end up occupying the most structurally vulnerable rental units.
Builder	Chief executive officer	Builders might promote stronger buildings if they enjoyed increased market value through higher resilience ratings, design standards modifications, density bonuses or favorable zoning, fee waivers, accelerated permitting	Increased construction activity and jobs, more jobs in structural materials manufacture and distribution. Greater construction costs may or may not be passed on to buyers.
Building official	Chief Building Official	Building officials might advocate for designing to exceed code requirements, but probably face cost pressure from builders	Less demand for post-disaster safety inspection.
City council, county board of supervisors	City council member, mayor, county supervisor		Enhanced public safety, reduced emergency response, accelerated recovery, reduced recovery cost, favorable BCEGS and CRS ratings, jobs, tax revenues, more likely to attract and retain residents and quality developers and businesses.
Insurer, secondary insurer	Chief underwriter; actuary	Reduced portfolio risk	Reduced pure premium, catastrophe risk, a reinsurance costs.
Loan provider	Bank, mortgage company	Increased loan security, asset risk reduction; credit quality of security-backed mortgages	



Stakeholder	Decision-maker	Incentives	Special costs and benefits
Financer	Real estate investment trust	Increased financing opportunities, asset risk reduction	
Architect and engineer	Design firms' project managers		Slightly greater fees. Possibly difficult explanations to owners and builders.

## 2.3. RESULTS FROM ADOPTING 2018 I-CODE REQUIREMENTS

### 2.3.1. Quantifying the Contributions of Code Adoptions

Across the country, code adoption is not uniform—the code editions in place vary widely from jurisdiction to jurisdiction. Some jurisdictions adopt new editions on a regular cycle, while others remain on older editions. With each new edition, additional benefits accrue. Some jurisdictions may capture these benefits in incremental pieces with each adoption, while others update their codes less frequently, during which time the benefits from more recent codes are not realized.

While not covered in the scope of this study (and not captured in the BCRs), jurisdictions consider multiple factors regarding the frequency of adoptions. The Institute's National Council on Building Codes and Standards (2018) has identified these considerations in the report: *Benefits and Challenges of a Timely Code Adoption Cycle*.

### 2.3.2. I-Codes Protect New Buildings from Different Perils in Different Places

In the United States, the I-Codes protect new buildings from natural hazards of various kinds. [Table 2-11](#) summarizes how many people are exposed to the hazards considered here: flood, hurricane wind, earthquake, and WUI fire. [Figure 2-19](#) illustrates their geographic distribution. [Figure 2-20](#) shows how 57 million Americans are subjected to multiple perils: hurricane wind, earthquake, or WUI fire. (The geographic information available was insufficient to include flooding in [Figure 2-20](#).) I-Codes also protect buildings from common building fires, straight-line winds, water intrusion, electrical damage, and other perils.

[Figure 2-19A](#) shows streams and rivers in the National Hydrography Dataset (US Geological Survey 2018), with a blank space in western Tennessee where streams have unassigned level. Colors relate to ranges of the size of streams and rivers. [Wing et al. \(2018\)](#) estimate that 13% of the U.S. population—42 million people—live in areas subject to flooding with at least 1% probability in 1 year. [Figure 2-19B](#) shows where hurricane winds affect the design of new buildings along the U.S. Gulf and Atlantic Coasts, that is, where ASCE 7-16's basic wind speed for Risk Category II buildings exceeds 115 mph. Approximately 127 million people live in these areas, or 39% of the U.S. population.

## NATURAL HAZARD MITIGATION SAVES:

Table 2-11: Population exposed to high risk from flood, hurricane, earthquake, or fire at the wildland-urban interface.

Peril	How severe	Population (million)	% U.S. population
Flood	At least 1% probability of flooding per year	42	13%
Hurricane	Basic wind speed for typical buildings > 115 mph	127	39%
Earthquake	Seismic design exceeds wind design	85	26%
Fire	High or very high wildfire hazard potential	59	18%

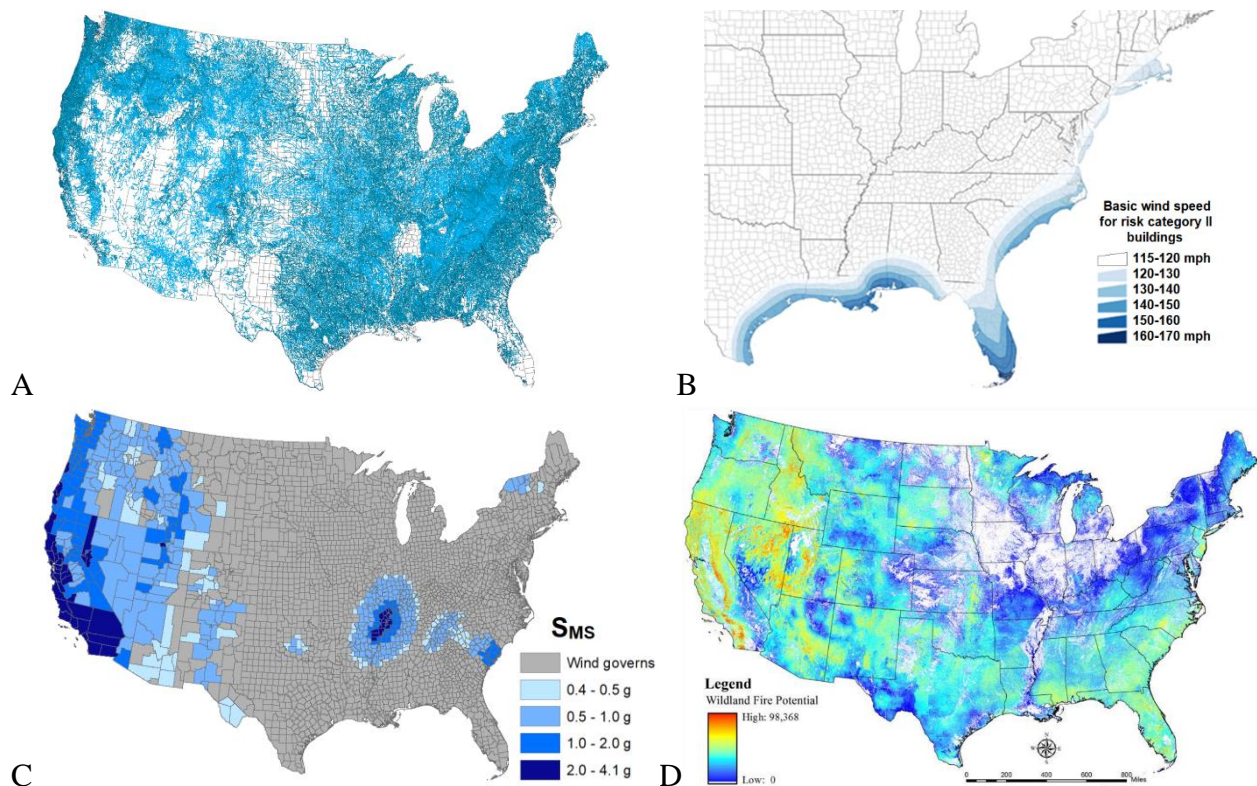

Figure 2-19: (A) U.S. streams and rivers; (B) Gulf and Atlantic Coast hurricane winds; (C) seismic design load; (D) wildland fire potential.

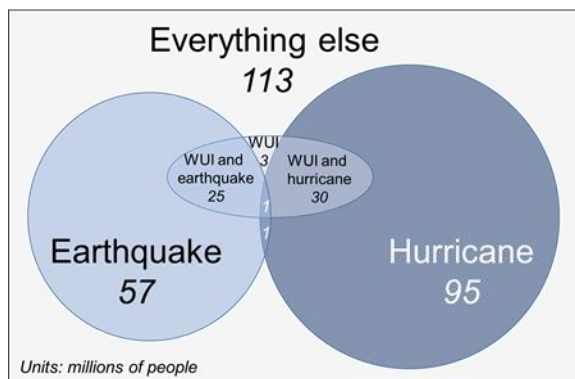

Figure 2-20: U.S. population exposed to various combinations of earthquake, hurricane, and fire at the wildland-urban interface.

### 2.3.3. Adopting 2018 I-Code for Riverine Flood

Minimum requirements for elevating buildings located within the Special Flood Hazard Area (SFHA) are primarily dictated by whether the building is to be constructed under the IBC or IRC. Since the 2006 edition of the IBC, buildings subject to riverine flood conditions that fall into Risk Category II and are constructed under the IBC have been required to have a minimum lowest floor elevation of BFE plus 1 foot or the locally adopted design flood elevation (DFE). This is because of requirements that buildings constructed to the IBC comply with ASCE 24 (American Society of Civil Engineers 2014). Ever since the 2005 edition of ASCE 24, buildings constructed for Risk Category II that are outside of High Risk Flood Hazard Areas (V zones and Coastal A zones) have been required to meet the previously stated elevation requirements. Elevation requirements for buildings constructed under the IRC however were not required to incorporate additional freeboard above the BFE until the 2015 edition of the IRC.

Based upon an analysis of communities within the United States as of February 25, 2015 approximately 61.98 percent of the U.S. population lives in communities where at least one foot of freeboard is required. Freeboard requirements can be incorporated into either a state or local floodplain management ordinance or by adoption of the I-Codes. This however does mean that approximately 38% of the U.S. population lives outside of areas with at least one foot of freeboard. This study only focused on communities that are members of the NFIP and compared the minimum NFIP requirements with those that have adopted at least one foot of freeboard. The project team further assumed that construction within the SFHA would comply with all the NFIP minimum requirements. These include dry floodproofing of nonresidential buildings. Any areas not dry floodproofed below the BFE would only be used for parking, building access, and storage. Those areas would be constructed with flood-resistant materials. Enclosures below BFE would include flood openings sized and located properly.

Buildings constructed in compliance with the IBC are projected to have a minimal increase in cost to comply with the additional elevation requirements, that is, to build so that their first story is at least at 1 ft above BFE, rather than at BFE. Commercial buildings were evaluated as slab-on-grade structures on a stemwall foundation. The additional increase in the foundation height of one foot added approximately

## NATURAL HAZARD MITIGATION SAVES:

1.2% to the overall cost of construction. Nonresidential buildings can be dry floodproofed as an alternative to elevation. Although this alternative represents a higher risk to the building, it is an allowable form of meeting compliance and may be preferred in some urban locations for aesthetics or accessibility. The additional cost of construction for one foot of dry floodproofing is approximately 1.7% of the overall cost of construction.

The national average BCR for incorporating one foot of freeboard into construction is based upon a weighted average of the percentage of each building type within approximately 18 different idealized floodplains. Each of the floodplains is either wide and flat or narrow and steep and described further in Section 5.2.3 of this report. Elevation is the predominant method for meeting compliance. Although less common, the cost effectiveness of dry floodproofing should also be evaluated with respect to adoption of the 2018 I-Codes since it is an allowable method of meeting compliance.

The project team evaluated residential buildings, specifically single-family, one- and two-story homes that fall under the IRC. The team evaluated these homes for two foundation types: slab-on-grade with a perimeter stemwall and a wood-framed floor system supported by a masonry perimeter wall with interior masonry piers (crawl space). For flat floodplains, the project team evaluated stemwall systems with a transition to a mixed grouping of both foundations in moderate sloped floodplains and transitioning to only crawl space foundations in steeply sloped floodplains. As previously stated, the project team only considered elevation for this evaluation since dry floodproofing is not an allowable method to achieve compliance with residential buildings. Construction costs for compliance with 1 foot of freeboard in the 2015 and 2018 I-Codes increased the cost of construction approximately 1.4% for one-story homes and 1.2% for two-story homes.

Figure 2-21 shows the sources of the reduction in future losses produced by flood code adoption: reduced property losses (building repairs and content replacement) contribute the largest part of the benefits, followed by ALE and direct BI, and insurance overhead and profit. The figure reflects savings relative to NFIP elevation requirements. The project team excluded life safety benefits from the evaluation since, during flood events, people are encouraged to evacuate buildings located in the SFHA. Additionally, the requirement for one foot of freeboard does not represent a sufficient increase in the factor of safety for consideration of life safety. While not evaluated in this study, a primary consideration for incorporating freeboard into building requirements is the potential for changes in flood conditions due to future conditions. For riverine buildings, these could include increased runoff due to future development or climatic changes that could change precipitation rates. Freeboard also addresses inherent uncertainty in flood data where flood elevations meet or exceed the 1 percent flood elevation more frequently than 1 percent annually.

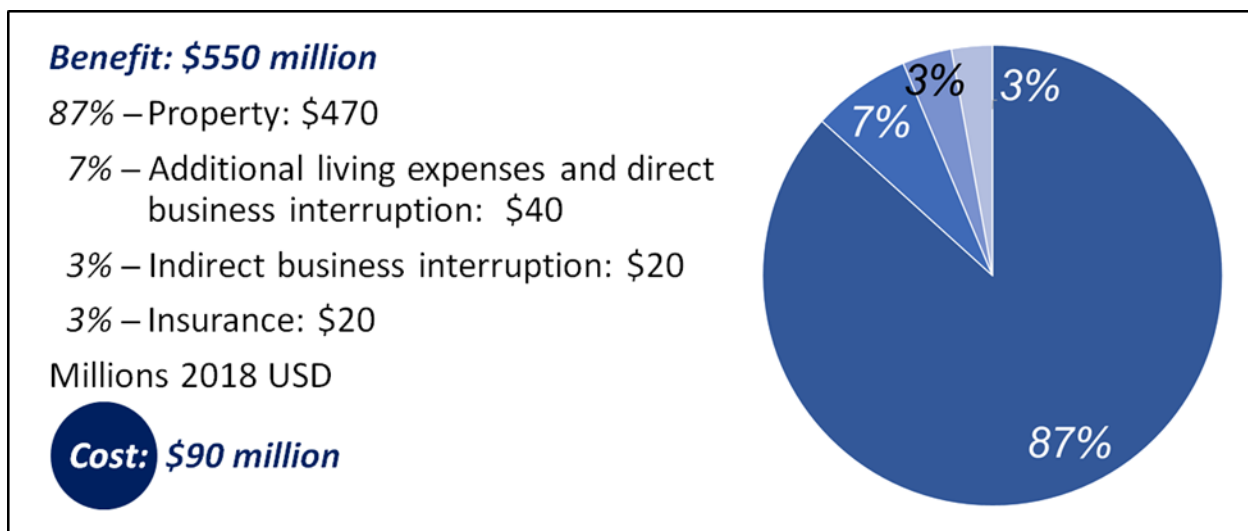

Figure 2-21: Sources of savings from I-Code adoption for flood.

### 2.3.4. Adopting 2018 I-Code for Hurricane Wind

What are the costs and benefits that Gulf and Atlantic Coast communities exposed to hurricane winds have derived from code development since circa 1990, just prior to Hurricane Andrew? The project team addressed that question by comparing the construction costs and future losses for buildings constructed under the current 2018 I-Codes, and those constructed under 1990-era code provisions: National Building Code (Building Officials and Code Administrators 1990) and Southern Standard Building Code (Southern Building Code Congress International 1991). The study area is bound by those regions currently located within the ASCE 7-16 hurricane prone regions (where the 700-year wind speed is greater than 115 mph).

Approximately 60 million people live in the 185 counties of the Gulf and Atlantic Coasts (U.S. Census Bureau 2016). Approximately 145 million people are located in the Gulf and Atlantic coastal states most threatened by hurricanes (U.S. Census Bureau 2016). Hurricane Andrew, which hit in 1992, caused an estimated \$27.3 billion in insured losses, destroyed approximately 26,000 homes, damaged another 101,000 (Insurance Information Institute 2018), and revealed several vulnerabilities in buildings subject to hurricane winds. The vulnerabilities included (among others) poor connections between roofs and walls, between roof decking and roof substructure, and the potential for windborne debris to penetrate the building envelope, causing increased internal pressures and water intrusion. Several building code changes were instituted to mitigate these deficiencies. Codes were further strengthened in later editions based on lessons learned after subsequent hurricanes and strong wind events.

For this study, the project team calculated the reduction in future losses for residential and commercial buildings subject to the stricter design requirements of current 2018 I-Codes, relative to 1990-era codes. The study addressed the evolving wind hazard maps and design procedures in post-1992 editions of ASCE 7, calculating their effect on design wind pressures, and considered changes through the IBC and IRC to incorporate new performance-based and prescriptive code requirements. Using these hazard data and

## NATURAL HAZARD MITIGATION SAVES:

current vulnerability models, the project team calculated the aggregate benefits and costs for typical single-family dwellings and commercial buildings under both 1990-era codes and 2018 I-Codes.

The 2018 I-Codes avoid an estimated \$10 of future loss for every additional \$1 of construction cost, relative to the 1990-era codes. Figure 2-22 sums benefits by category for every year of new construction along the Gulf and Atlantic Coasts that complies with I-Codes. Figure 2-23 shows how the BCR varies geographically, with the greatest benefits accruing in the regions of highest wind hazard.

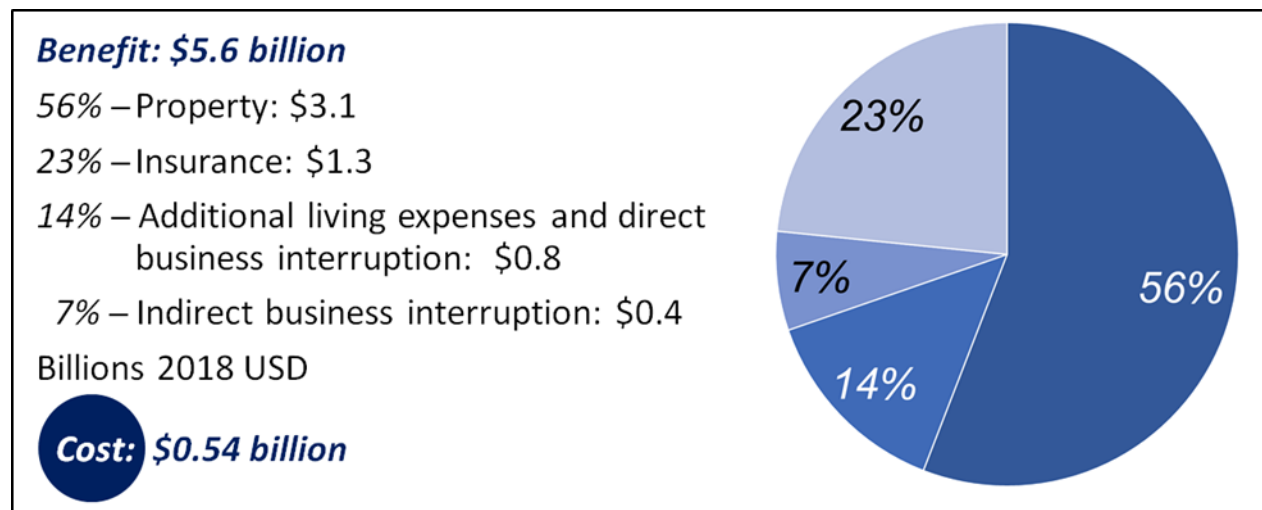

Figure 2-22: Sources of savings from I-Code adoption for hurricane winds.

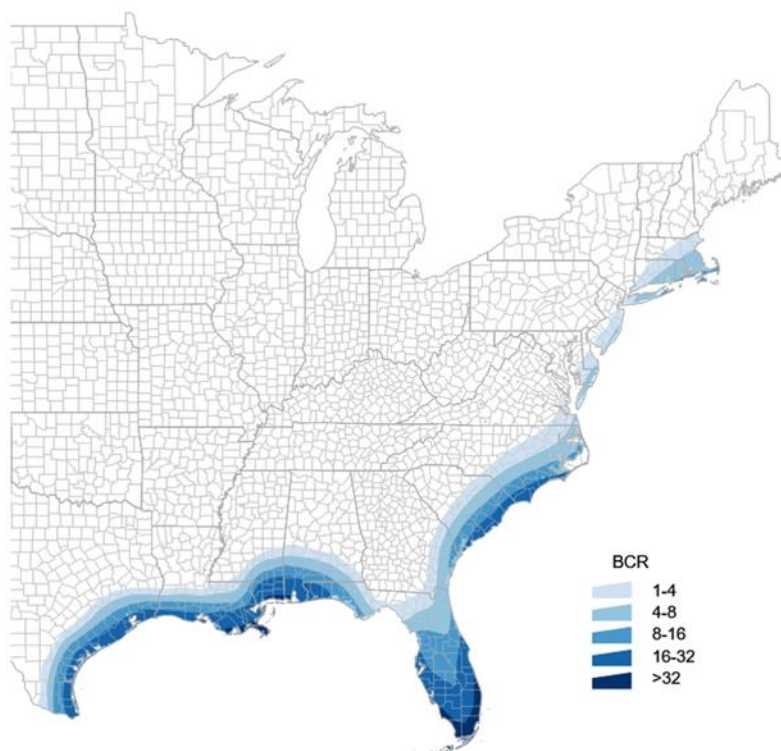

Figure 2-23: BCR for 1990-era construction designed instead to 2018 I-Codes.

### 2.3.5. Adopting 2018 I-Code for Earthquake

What benefit has been derived from adopting modern seismic design requirements over the long term? The project team estimated the costs and benefits of code increases to the required strength and stiffness of new buildings since (approximately) 1990. The team did so by estimating the future natural-hazard losses of one year of new construction, two different ways. First, the project team estimated the future losses of new buildings assuming they are all built to comply with the 2018 I-Codes. Then the project team estimated the losses again as if the buildings were all weaker and more flexible, more like 1990 construction. The latter case generally produced higher losses, but at lower up-front construction cost. The difference in loss is taken to be the benefit of code development since the 1988 Uniform Building Code. The project team chose 30 years to reflect changes, since shortly after the advent of what one might call modern seismic design, which accounts for a variety of issues such as the differing ability of different kinds of structural systems to absorb damage without collapse (a concept called ductility capacity). Codes have changed in other ways as well (see Section 3.3.3 for discussion), but strength and stiffness increases are fairly fundamental developments and practical to model.

An analysis of long-term trends in the design strength and stiffness required by the International Building Code, and before it, the Uniform Building Code, shows that building strength and stiffness increases on the order of 50% every 30 years, at least in the higher-risk areas in the western United States (WUS). That is, the average West Coast building 30 years ago was weaker and more flexible by a factor of 1.5, meaning

## NATURAL HAZARD MITIGATION SAVES:

67% as strong and stiff; 60 years ago, by a factor of 1.5<sup>2</sup>, meaning 44% as strong and stiff; and 90 years ago, by a factor of 1.5<sup>3</sup>, meaning 30% as strong and stiff. Therefore, one can deduce the costs and benefits of adopting modern codes compared with strength and stiffness roughly comparable to 1990, 1960, and 1930 requirements.

The current minimum design strength for earthquake loads exceeds that of wind where approximately 58 million people live, or about 26% of the U.S. population, in the contiguous 48 states, as shown in Figure 2-19C. While the BCR varies geographically, in the aggregate, the development and adoption of seismic provisions since the advent of modern seismic design provisions has produced a BCR of 12:1, \$12 saved for every \$1 of additional construction cost. Compliance for one year costs \$600 million more than if new buildings were built 67% as strong as the 2018 I-Codes require (i.e., to approximately 1990 requirements), but will save \$7 billion during a life of approximately 75 years, and would prevent 15 deaths and 22,000 nonfatal injuries.

Figure 2-24 shows the sources of the reduction in future losses produced by an increase in strength and stiffness associated with the development of modern seismic design provisions. Reduced property losses (building repairs and content replacement) contribute the largest part of the benefits, followed by direct BI, casualties (deaths, injuries, and instances of post-traumatic stress disorder), indirect BI, and urban search and rescue. The figure reflects savings relative to 67% of current strength and stiffness. BCRs for code adoption vary geographically, as shown in Figure 2-25. The highest BCRs generally appear in areas of highest seismicity, with values as high as 32:1 in San Bernardino County, California. Other notable locations include:

- San Francisco, California 24:1
- Los Angeles, California 23:1
- Seattle, Washington 7:1
- Salt Lake City, Utah 7:1
- Portland, Oregon 3:1

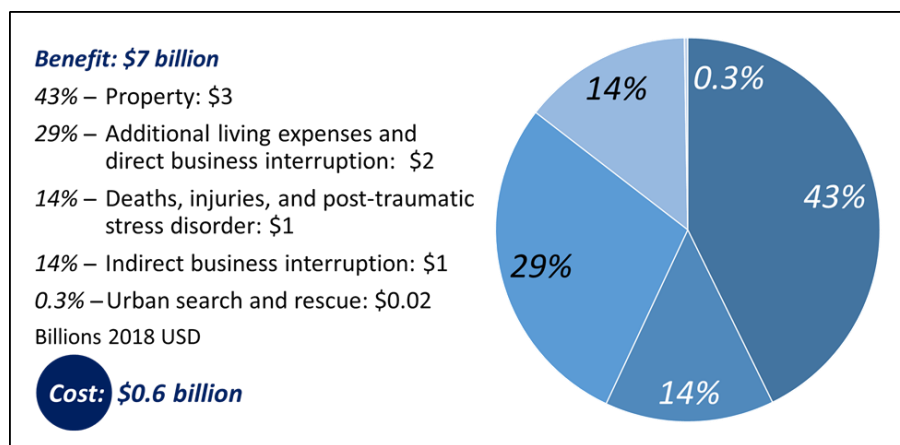

Figure 2-24: Sources of savings from I-Code adoption for earthquake.



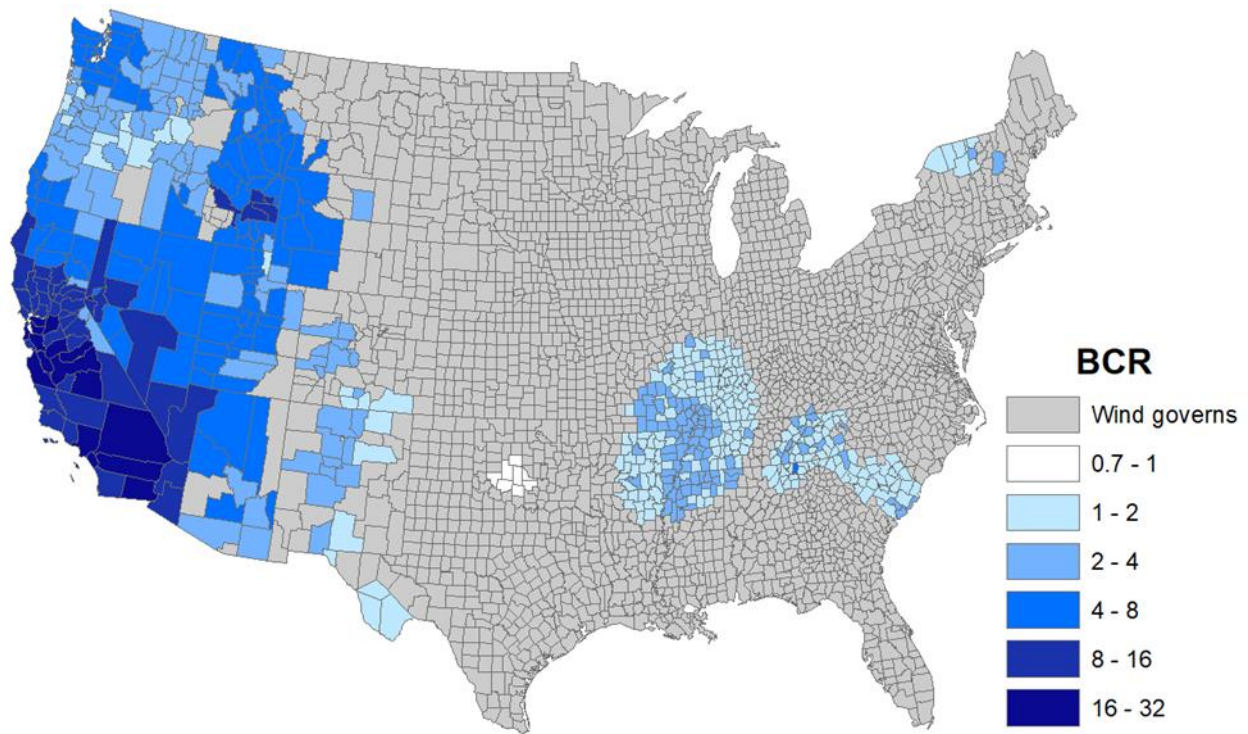

Figure 2-25: BCRs resulting from updating from 1990 construction to the strength and stiffness requirements of the 2018 I-Codes.

## 2.4. RESULTS FROM ENHANCING UTILITIES AND TRANSPORTATION LIFELINES

In 2018, the project team evaluated a number of EDA grants and found 12 that specifically mitigated natural hazard risk to utilities and transportation lifelines, where sufficient data were available to estimate benefits and costs. The project team estimated these benefits and costs, as well as a program by the California Department of Transportation (Caltrans) to seismically retrofit highway bridges throughout California, focusing on 656 highway bridges in Southern California. The project team also estimated the benefits and costs of a hypothetical program to seismically retrofit the distribution system of buried pipelines in an urban water supply system using a so-called resilient grid: a backbone of earthquake-resistant pipes and valves to better ensure that water is available within a half mile or so of any place in the system, regardless of damage to the rest of the system. Finally, the project team estimated the benefits and costs of a hypothetical program to seismically retrofit equipment in the substations of an electric distribution system, to better ensure that electricity will be available to customers. The project team also examined two hypothetical programs, a resilient water grid and a resilient electric grid, in each of four West Coast cities: Los Angeles, San Francisco, Portland, and Seattle.

In 2018, the project team evaluated a number of EDA grants and found 12 that specifically mitigated natural hazard risk to utilities and transportation lifelines, where sufficient data were available to estimate

## NATURAL HAZARD MITIGATION SAVES:

benefits and costs. The project team estimated these benefits and costs, as well as a program by the California Department of Transportation (Caltrans) to seismically retrofit highway bridges throughout California, focusing on 656 highway bridges in Southern California. The project team also estimated the benefits and costs of a hypothetical program to seismically retrofit the distribution system of buried pipelines in an urban water supply system using a so-called resilient grid: a backbone of earthquake-resistant pipes and valves to better ensure that water is available within a half mile or so of any place in the system, regardless of damage to the rest of the system. Finally, the project team estimated the benefits and costs of a hypothetical program to seismically retrofit equipment in the substations of an electric distribution system, to better ensure that electricity will be available to customers. The project team also examined two hypothetical programs, a resilient water grid and a resilient electric grid, in each of four West Coast cities: Los Angeles, San Francisco, Portland, and Seattle.

The 12 EDA grants included five grants to elevate roads and railroads to better resist flooding; four grants to protect water and wastewater treatment plants from future flooding; one grant to protect an electric and telecommunication substation from flooding; and two grants to underground electric transmission lines to protect them from wind and ice loads. The 13 actual mitigation programs examined here (the 12 EDA grants and the Caltrans retrofit program) cost approximately \$590 million in 2018 dollars, and are estimated to save society \$2.5 billion, for a total benefit-cost ratio of 4 to 1. The benefits mostly accrue from reductions in deaths, injuries, and post-traumatic stress disorder (39%) and indirect business interruption (38%), with smaller contributions from additional living expenses, direct business interruption, property loss, and environmental impacts, as shown in Figure 2-26.

The hypothetical measures to construct a resilient water supply grid and a resilient electric grid also appear to be generally cost effective, with BCRs ranging from 1 to 8, depending on location. Cities with higher seismicity (San Francisco and Los Angeles) exhibit higher BCRs.

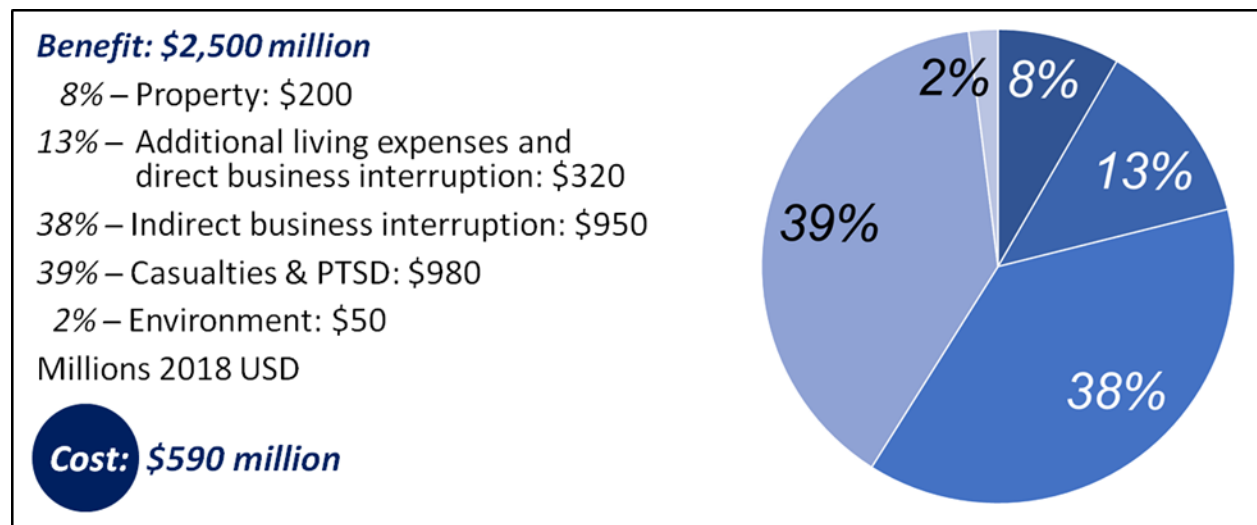

Figure 2-26: Benefits of the examined utility and transportation lifeline mitigation efforts.

## 2.5. RESULTS FROM FEDERAL GRANTS

This section presents results of the project team’s analyses of federal grants, including FEMA and HUD grants, to mitigate risk from riverine flooding, hurricane and tornado winds, earthquake, and fire at the WUI.

### 2.5.1. Grants for Flood Mitigation

While the BCR varies between projects, public-sector mitigation spending for the acquisition of buildings exposed to riverine flooding appears to be cost effective. The average BCR across the sample projects is approximately 7:1; its standard error, 2.0. The implication is that past federally funded riverine flood mitigation is cost effective (at the cost-of-borrowing discount rate). Given that the total cost of all riverine flood-mitigation grants was \$11.5 billion, a BCR of 7:1 implies that federally funded flood mitigation will ultimately save the United States \$82 billion.

Based on the distribution of benefits from the various categories within the sample grants, the \$82 billion in benefits can be attributed to different categories as shown in Figure 2-27: \$53 billion in avoided property losses (65% of the total); \$15 billion (18% of the total) in avoided ALE, sheltering, and indirect BI; \$9 billion (11%) from reduced administrative costs associated with flood insurance; and the balance of \$5 billion (6%) from acceptable costs to avoid deaths, injuries, and PTSD.

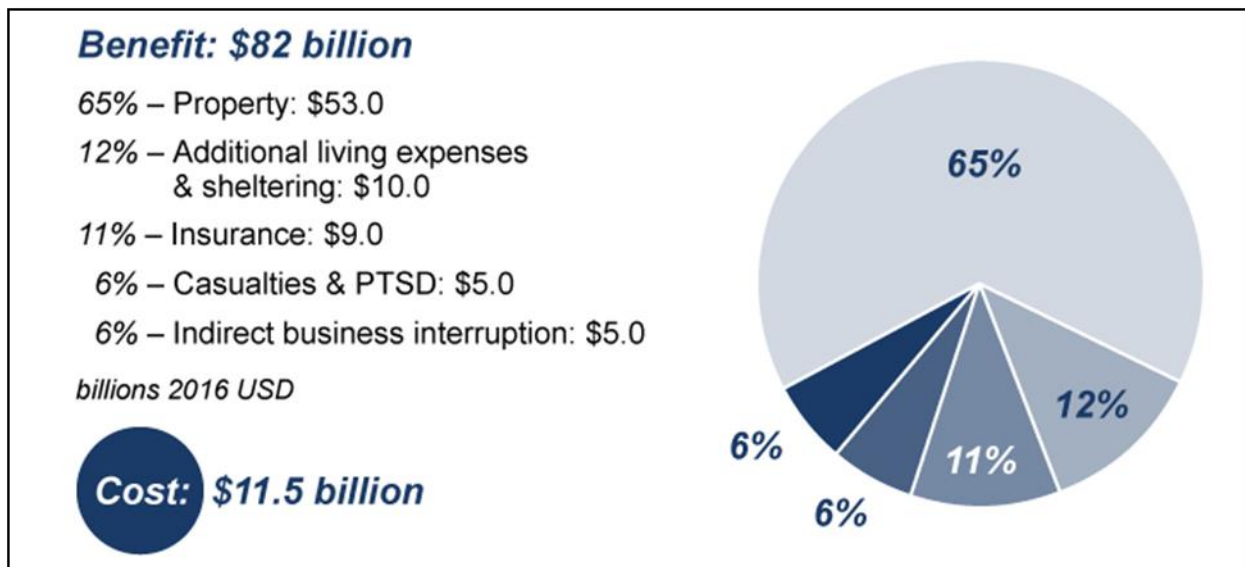

Figure 2-27: Contribution to benefit from federally funded riverine flood grants.

Table 2-12 summarizes benefits and costs of public-sector spending to acquire or demolish flood-prone buildings, especially single-family dwellings, manufactured homes, and 2-4 family dwellings. The results reflect analyses of five projects using Hazus<sup>®</sup> MH (Hazus) and the baseline cost-of-borrowing discount rate. The table shows project number, location, total mitigation cost, the present value of future probabilistic

## NATURAL HAZARD MITIGATION SAVES:

losses had the mitigation not been undertaken, the present value of losses given that mitigation was undertaken, the difference between the two (e.g., the avoided losses, or benefit), and the BCR.

Results are shown in thousands, rounded to the nearest \$10,000. The values in Table 2-8 use the 2.2% cost-of-borrowing discount rate. See Section 2.5 for 3% and 7% discount rates. Results were calculated in 2014 USD but inflated to 2016 USD using a gross domestic product (GDP) deflator (purchasing power parity—PPP—per capita in international dollars, from the World Bank).

**Table 2-12:** Costs and benefits of sampled grants for riverine flood acquisitions (in thousands).

Project	County	Cost	Pre-mitigation loss	Post-mitigation loss	Benefit	BCR
45918	Morgan, IN	\$ 2,790	\$ 27,710	\$ 1,040	\$ 26,670	9.6
28096	Wagoner, OK	\$ 1,220	\$ 19,760	\$ 8,030	\$ 11,730	9.6
53458	Decatur, GA	\$ 950	\$ 2,200	\$ 0	\$ 2,200	2.3
58141 PDM	DeKalb, GA	\$ 4,230	\$ 8,540	\$ 2,500	\$ 6,040	1.4
32571	Polk, WI	\$ 490	\$ 68,720	\$ 62,540	\$ 6,180	12.5

**Evaluating Reasonableness of the Results.** The sample-average BCR of 7:1 is higher than the 5:1 figure for riverine flood estimated in the *2005 Mitigation Saves* study. Considering variability between grants, agreement within 40% is satisfactory, and tends to support the conclusion that flood-mitigation is cost effective. The fact that the *Report* estimate is higher than in the 2005 study is perhaps attributable to Hazus. The project team used the Hazus flood module here, whereas the authors of the 2005 study used fairly cautious and approximate methods because their work began before the availability of a fully functioning Hazus flood module. In the face of great uncertainty, the authors of the *2005 Mitigation Saves* study decided to err on the side of underestimating losses.

One more observation about Table 2-9: the per-building cost of the Georgia grant was more than three times those of the Indiana and Oklahoma grants, which seems questionable. It may be that the available data omit some buildings from the acquisition, or that they were miscoded and appear elsewhere in the database. In either case, the analysis would underestimate the benefit and therefore the BCR. If true, the accurate BCR for the Georgia grant would be closer to that of most of the other grants, and the overall average would be higher.

### 2.5.2. Grants for Wind Mitigation

Based on its analysis, the project team found that federal grants to mitigate wind damage are highly cost effective. In 23 years, public entities have spent \$13.6 billion to mitigate future wind losses; these efforts will ultimately save the United States an estimated \$70 billion in avoided property losses, ALE, business impacts, and deaths, injuries, and PTSD. Their total BCR is approximately 5:1.

## NATURAL HAZARD MITIGATION SAVES:

Table 2-13 presents the benefits of mitigating wind damage. The low- and medium-hazard projects focused primarily on life safety. These life-safety focused projects produce very large benefits, primarily because of the acceptable cost to avoid a statistical fatality (\$9.5 million) and smaller but still fairly large acceptable costs to avoid nonfatal injuries, and because this analysis does not discount human life. Figure 2-28 details the contribution to overall benefits from the various benefit categories considered here.

**Table 2-13:** Costs and benefits of sampled federal grants to mitigate wind damage (in millions).

	Low hazard	Medium hazard	High hazard	Overall
BCR	6.2	6.5	3.3	5
Total stratum cost	\$ 1,580	\$ 6,550	\$ 5,450	\$ 13,580
Total stratum benefit	\$ 9,860	\$ 42,440	\$ 17,930	\$ 70,230

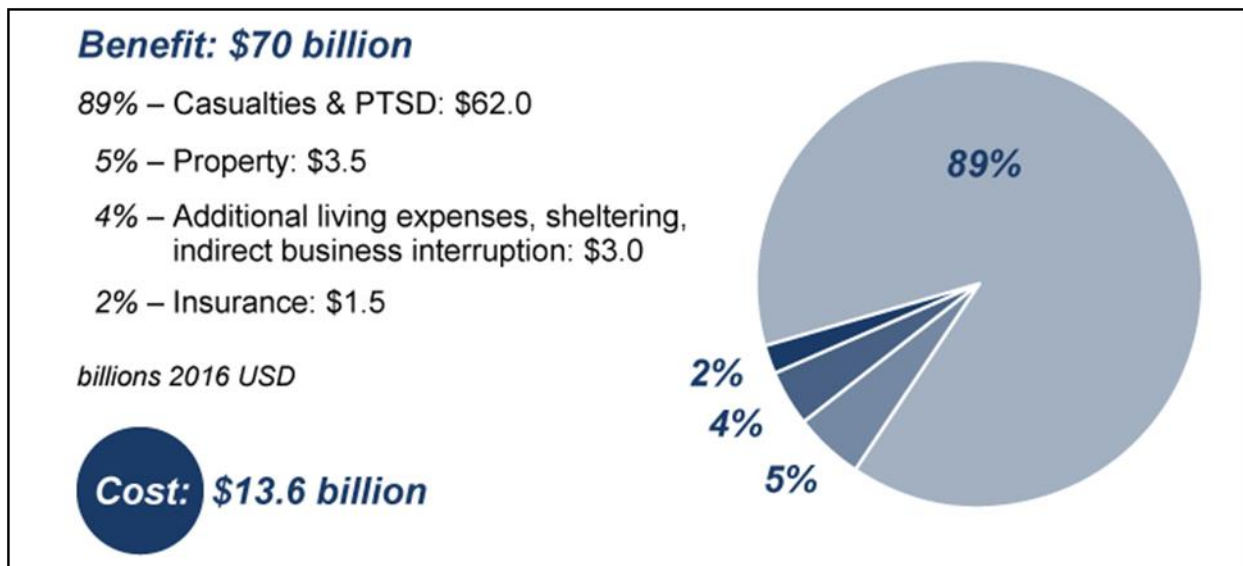

**Figure 2-28:** Contribution to benefit from federally funded wind grants.

Not every life-safety mitigation project results in a BCR greater than 1.0, but that might have as much to do with the available data as with the actual mitigation effort undertaken. The estimated BCR depends largely on the level of hazard, alternative use of the facility, and accessibility. In-home safe rooms generally appear to be cost effective, exhibiting an average BCR of 4.25. Large facilities with dual purposes, such as school gymnasiums and cafeterias, exhibit an average BCR of 8.0. In these cases, the cost of mitigation is simply the additional cost of hardening the facility.

Accessibility and use also strongly affect cost effectiveness. For example, a shelter located at a hospital will likely protect life at any time of day throughout the year. By contrast, for much of the year and many times of day, nobody is likely to be near enough to need a small shelter in a large park. On a probabilistic basis, such shelters provide lower benefits.

## NATURAL HAZARD MITIGATION SAVES:

The location of the hazard mitigation effort matters too. The same kind of wind-mitigation efforts in Oklahoma produce higher estimated benefits than they do in North Dakota. The kind of mitigation matters as well. Shutters appear to be highly cost effective, particularly those that protect valuable equipment at utilities or industrial facilities. Shutters for ordinary public buildings without high-value contents produce a lower but still impressive BCR (about 3.5).

The challenge for the project team was that the members had to estimate the benefits of county-wide residential retrofitting projects without data specifying exactly what was done to each building. The project team identified likely mitigation efforts for older and newer buildings, and used the American Community Surveys (U.S. Census Bureau 2010–2014) to estimate the number of homes built before and after major code changes, especially the implementation of the *Florida Building Code* (FBC) in 2002 (State of Florida 2002). County-wide residential retrofit projects resulted in a BCR of 1.5 to 3.5.

**Evaluating Reasonableness of Results.** The project team produced a 33% larger BCR for wind mitigation than in the *2005 Mitigation Saves* study, e.g., 5:1 (Interim Study) versus 4:1 (*2005 Mitigation Saves* study). The difference can be attributed largely to the longer period over which the Interim Study recognized mitigation benefits: 75 years versus 50 years in the *2005 Mitigation Saves* study. At an approximate 2.2% annual discount rate for cost of borrowing, a 75-year annuity is worth about 21% more than a 50-year annuity with the same coupon payment. The remaining 10% difference could be a function of the uncertainty associated with this sampling strategy.

### 2.5.3. Grants for Earthquake Mitigation

Considering mitigation costs totaling \$2.2 billion, the average BCR of approximately \$3 to \$1 implies that federally funded earthquake hazard mitigation between 1993 and 2016 saved society \$5.7 billion, in approximately the proportions shown in Figure 2-29. Note that few buildings are insured for earthquake shaking, so the analysis ignored insurance benefits.

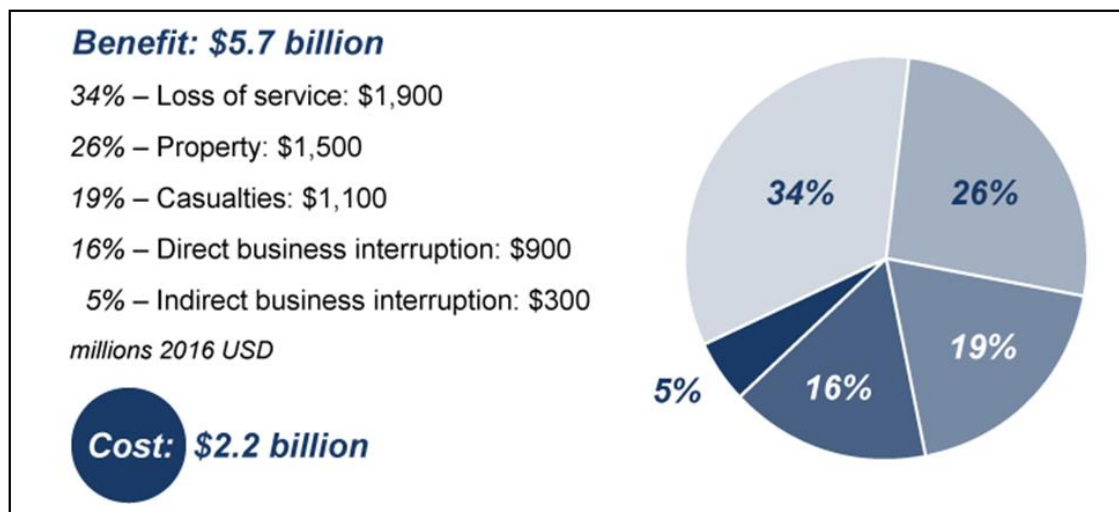

Figure 2-29: Contribution to benefit from federally funded earthquake mitigation grants.

## NATURAL HAZARD MITIGATION SAVES:

The analysis produced a standard error of BCR equal to 0.56, which measures uncertainty in the stratum-average BCR. It suggests that, with more than 99% confidence, the true population-average BCR exceeds 1.0. The sample strongly suggests that 23 years of federally funded earthquake mitigation of public buildings has been cost effective. It will save the public more than it cost, on average, over the long run, which is the basis of BCA, even for earthquakes.

**Evaluating Reasonableness of the Results.** This section examines the estimated benefits of federal grants supporting earthquake risk mitigation, beginning with a comparison with the *2005 Mitigation Saves* study. The estimated BCR of 3:1 (2.6:1 when shown with more precision) is 73% higher than the 2005 estimate of 1.5. The project team attributed some of the difference (21%) to recognizing benefits over 75 years rather than 50 years. The team attributed most of the remaining difference to the new ability to estimate the value of loss of service to the community—a capability of FEMA's BCA (Benefit-Cost Analysis) Tool that was not available for the *2005 Mitigation Saves* study. As shown in Figure 2-18, loss of service represents approximately one-third of the estimated benefits. If one omits loss of service and reduces all other benefit categories by a factor of 1.21 to reflect a 50-year life versus 75 years, the BCR would be 1.43, almost the same as in 2005. The similarity tends to support the new figure.

**Discussion.** A linear regression of BCR against project cost within the sample of 23 projects reveals a low coefficient of determination:  $R^2 = 0.03$ , suggesting that BCR is not linearly related to project cost. That is, spending more does not necessarily save disproportionately more. (Nor does the other way hold true: spending less does not save more either.)

The nature of the mitigation efforts seems more closely related to the BCR. The most apparently cost-effective mitigation efforts address utilities and other lifelines: electrical substations, hospitals, and fire stations (average BCR of 4.5), followed by education (1.7), then public administration and other miscellaneous efforts (about 1.0).

It may be that the analysis underestimates the BCR for the last category, especially if public administration provides public services after an earthquake that are too intangible to be quantified yet by the FEMA BCA Tool. The orderly operation of government seems more important in the immediate aftermath of a natural disaster than at other times. Therefore, the benefits associated with efficient government in the immediate aftermath of a disaster may represent an omitted benefit category.

Also, it seems likely that having operating schools matters a lot in the aftermath of an earthquake, so parents do not need to interrupt work to care for children because school is closed. A BCR of 1.7 might therefore underestimate the true BCR for mitigating public school buildings, because it omits a benefit category for childcare. Viewed another way, if one parent in a two-income household has to stop work to care for children while their school is nonfunctional, the indirect BI would increase. This fairly indirect cost is probably not reflected in the indirect BI cost to the economy conditioned on loss of function in education.

As with the 2005 study, property benefits alone do not equal mitigation cost, but the sum of property and casualties do. By adding other societal benefits—BI losses and especially loss of service to society—

earthquake mitigation more than pays for itself. That observation reinforces the notion that earthquake risk mitigation broadly benefits society. That is, the benefits of strengthening one building extend far beyond the property line: the benefits also go to the families of the people who work in the building and to the community that the building serves.

### 2.5.4. Grants to Mitigate Fire at the WUI

This section presents estimates of the costs and benefits of federally funded efforts to mitigate fire at the WUI. The project team used many of the same principles and processes to analyze mitigation grants as it did for analyzing above-code measures. With a total project cost of approximately \$56 million (inflated to 2016 USD), federally supported mitigation of fire at the WUI will save society an estimated \$173 million in avoided future losses. Applying the relative contribution from benefit categories calculated in the above-code measures study yields Figure 2-30, which shows the estimated contribution of benefits produced by federally funded grants to mitigate fire risk at the WUI.

For reasons explained in Chapter 5, the project team used results of above-code measures to impute a BCR for many grants in the sample. The project team imputed the BCRs for making a typical single-family dwelling comply with the 2015 IWUIC to federal mitigation grants such as replacing private residential roofs (with a requirement for vegetation management) and to grants associated with vegetation management.

In summary, of the 25 grants with sufficient data available, the project team estimated BCRs for four on the basis of project-specific, and imputed BCRs for 21 using results from above-code measures based solely on grant location. Of the former four, two had a BCR greater than 1.0; two, less than 1.0. Of the 21 latter grants, eight had BCRs greater than 1.0; 13 had BCRs less than 1.0. In some cases, the properties were close to a boundary between locations with BCRs of greater than 1.0 and less than 1.0. Given issues of locational accuracy and uncertainty in the above-code study results, the BCRs determined using these results are only approximate. For the 25 grants with sufficient data, the analysis produced an average BCR of approximately 3:1.



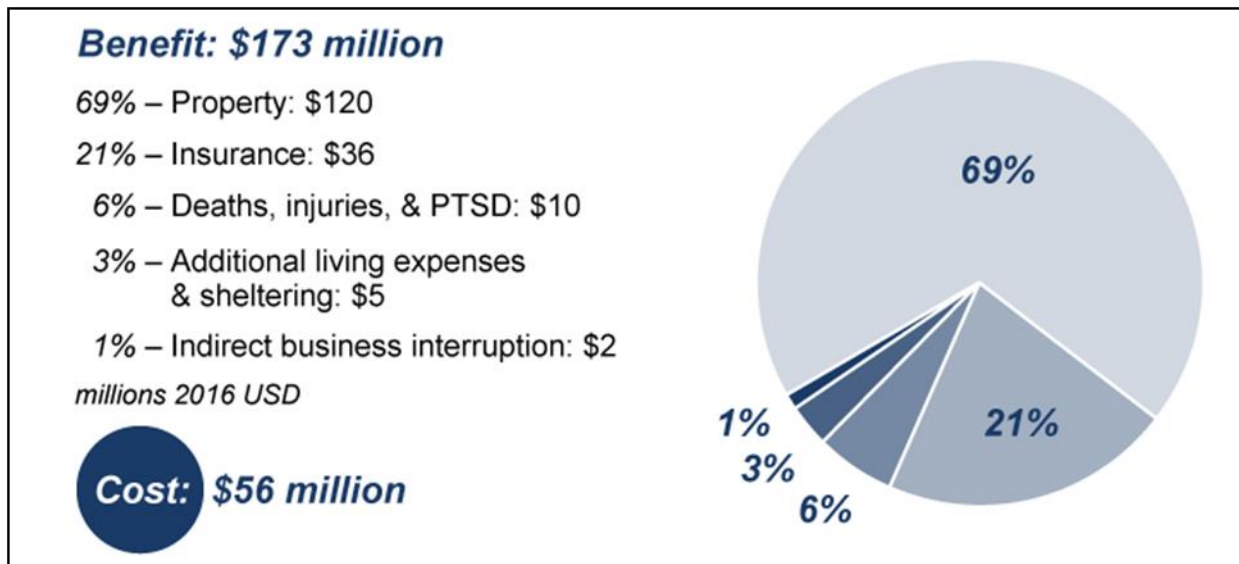

Figure 2-30: Contribution to benefit from federally funded WUI fire mitigation grants.

## 2.6. BCRS FOR RETROFIT OF PRIVATE-SECTOR BUILDINGS

### 2.6.1. BCRs for Flood Retrofit of Single-Family Dwellings

#### 2.6.1.1. Flood Retrofit Measures for Single-Family Dwellings and Total BCR

Flood retrofits evaluated for this study specifically focused on those to single-family houses that are subject to riverine floodwaters. According to analysis by NOAA, inland flooding damage from 1980 to 2018 cost the U.S. approximately \$4.3 billion per year (CPI-adjusted) (National Oceanic and Atmospheric Administration 2018), and it is expected that value will continue to increase. This analysis estimated the value of mitigating existing single-family houses that currently stand within the National Flood Insurance Program's delineated special flood hazard area (SFHA). Often called the 100-year floodplain, these are places with a 1 percent or greater chance of being flooded in an average year, which equates to about a one in seven chance of being flooded at least once during a 15-year mortgage, and more than 50% chance of being flooded during a 75-year life of a building. The reader can learn whether any particular address is located within a special flood hazard area using FEMA's Flood Map Service Center, currently located at <https://msc.fema.gov/portal/home>.

The evaluation focused on houses that were constructed prior to the implementation of flood maps in the areas where they were built. Designers of these single-family dwellings would have lacked sufficient flood elevation data to construct the lowest floor elevation at or above the base flood elevation (BFE), meaning the elevation of the 1 percent annual chance flood. New or revised flood maps sometimes extend the floodplain to places that previously were outside of it, or otherwise change in such a way that formerly compliant buildings now are below the BFE. Such situations apply to relatively few buildings, so this study focused on older existing building that often are more at risk.

## NATURAL HAZARD MITIGATION SAVES:

The project team evaluated five flood retrofit measures, selecting methods that are either commonly funded by mitigation grants (1 and 2) or that homeowners can do themselves (2 through 5). They include:

1. Acquisition of property, called buyouts, where the property is purchased and the building removed; commonly funded by mitigation grants. Eliminates future losses.
2. Retrofit elevation, that is, the raising of buildings; commonly funded by grants and sometimes by homeowners. Greatly reduces future losses.
3. Wet floodproofing of basements by removing damageable items from easily flooded places. Rarely funded by grants. Can be done by homeowners to reduce loss in more frequent flooding.
4. Elevation of air conditioning compressors or heat pumps and relocation of ductwork. Rarely funded by grants. Can be done by homeowners to reduce loss in more frequent flooding.
5. Relocation of furnaces and water heaters from basements and crawlspaces. Rarely funded by grants. Can be done by homeowners to reduce loss in more frequent flooding.

Figure 2-31 summarizes the benefits that could be derived from a realistic combination of the five retrofit measures performed on existing single-family dwellings in the 100-year floodplain. Mix of the Section 5.5.6 provides details. Benefits for each retrofit option were calculated on a per building basis. Percentages for each flood retrofit type were developed after an analysis of a state grant program and expert opinion. The percentages for each flood retrofit were then applied to one million single-family dwellings. The number of single-family dwellings in the 100-year floodplain that predate their flood maps is uncertain. The figure of one million buildings is probably at the low end of a realistic range. It was used here partly to be consistent with the project's policy of err toward lower benefit in cases of significant uncertainty, and partly because it is a round number that makes adjustment easy if one believes a different number of older homes in the floodplain. Each flood retrofit measure was evaluated based on the lowest floor being within a range of elevations below the BFE. Many houses exist in the floodplain with lowest floors even lower than assumed here. While this study does not represent the benefits associated with retrofitting all existing houses constructed prior to the adoption of flood maps, it does illustrate the benefit of flood mitigation applied to a large subset of the existing single-family dwellings in the floodplain. These calculated benefits for each retrofit were then summed to develop the total costs and benefits for flood retrofits and resulting in a total BCR of just over 5:1.

## NATURAL HAZARD MITIGATION SAVES:

**Benefit: \$1,260 billion**

77% – Property: \$970

14% – Additional living expenses: \$180

7% – Indirect business interruption: \$85

2% – Deaths & PTSD: \$25

Billions 2018 USD

**Cost: \$230 billion**

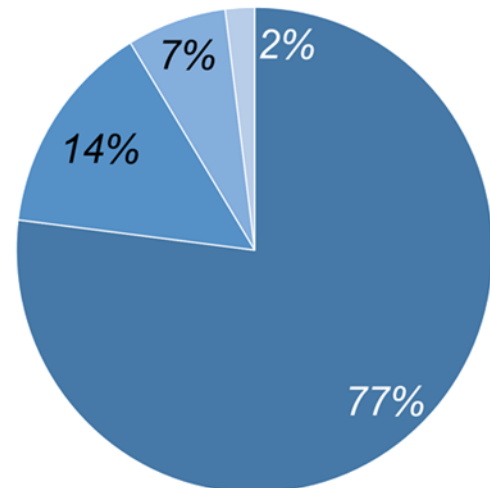

Figure 2-31: Flood-related benefits from all the evaluated retrofits to flood-prone single-family dwellings.

Costs and benefits for the flood retrofit projects differ from the other perils considered here in that flood was evaluated on a nationwide basis rather than a county-by-county basis. This was done to avoid the formidable challenge of calculating hydrology and hydraulic data for thousands of watersheds. The following few sections provide detail of the benefit sources for individual flood-retrofit measures.

### 2.6.1.2. Acquisition of Single-Family Dwellings

Buyouts represent permanent flood mitigation: The building no longer exists to be flooded, and its occupants relocate to a place with much-lower flood risk. Properties with a high risk of flood damage often are identified by communities for grant applications and then these properties are purchased and the land used for something that would not result in future flood losses. These uses often are open spaces, such as parks, gardens, or greenspaces. In addition to avoiding future flood losses, the unbuildable land helps to open space within the floodplain and expand the storage capacity of the floodplain. By eliminating sufficient numbers of properties, buyouts help to reduce the flood risk to surrounding properties.

The acquisition of a property involves buying the house, land, and any other improvements. This option can be costly, but it is viewed as the most comprehensive one. For present purposes, the cost of acquisition was based on the square-footage price for a home with mortgage of \$228,600, which assumes an average 1,800-square-foot house costing \$127 per square foot.

Acquisition improves life safety. When people die in floods, it is commonly because they are driving through floodwaters. Moving people out of the floodplain reduces the chance that occupants get hurt driving to or from their homes. Buyouts also protect first responders and police because they do not have to respond to that house during a flood.

## NATURAL HAZARD MITIGATION SAVES:

Figure 2-32 details the benefits estimated for acquisition of single-family dwellings in floodplains. It assumes a 100-year project useful life. Many other benefit-cost analyses assume a house lasts 75 years, but buyouts are a little different. Once a community makes property unavailable for dwellings, it probably will remain that way. It is difficult to know for how long, but 100 years seems to be a reasonable, perhaps conservatively low, figure.

### **Benefit: \$1,160 billion**

77% – Property: \$890

14% – Additional living expenses: \$170

7% – Indirect business interruption: \$80

2% – Deaths & PTSD: \$20

Billions 2018 USD

**Cost: \$180 billion**

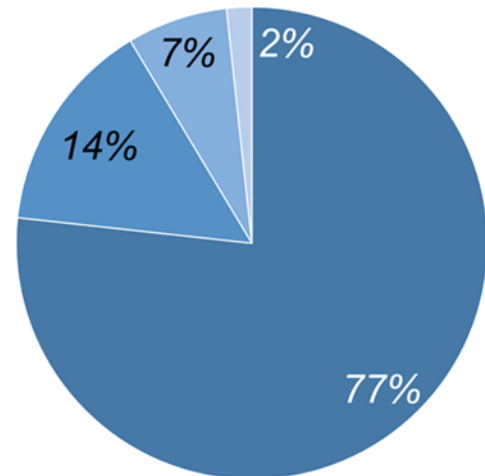

Figure 2-32: Contribution flood-related benefits from the acquisition of flood-prone single-family houses.

This analysis is blind to some maintenance costs and changes in property tax associated with acquisitions. Community leaders often express concern that acquisitions reduce their property tax base if residents relocate outside the municipal limits. Communities have been able to use rezoning strategies in other portions of the community outside of the SFHA to limit their exposure to a reduced property tax base. Other communities have found that acquisitions can lead to ongoing maintenance costs, such as mowing. Over time, some communities have found ways to reduce those maintenance costs, including using the acquired land for community gardens that volunteers maintain. Other communities have acquired contiguous properties to create green spaces that open up valuable park space that the community otherwise would have had to purchase. Communities that perform buyouts may or may not plan for or successfully encourage displaced people to relocate within local jurisdictions. If they fail, they may lose property tax revenues. If the displaced households remain in the region, the lost taxes are recouped by another community, in which case the present analysis would be blind to the

### **Taking the Opportunity to Acquire Houses**

Flood conditions and flood elevations can change over time due to increased development or changes in precipitation rates. When comparing acquisition with retrofit elevation, it should be considered that once a house is elevated it may be difficult to show that it is cost effective to acquire the house even if BFEs rise above the lowest floor elevation. The best opportunity to acquire a house is prior to retrofit elevation.

loss of tax revenue in one part of the region because it is recovered elsewhere. A knowledge base exists among floodplain managers on how to minimize loss of tax revenue and costs to maintain the acquired property. When large groups of properties have been acquired, surrounding properties outside of the floodplain could see increased property values because of their proximity to open spaces. These gains are not recognized in the present analysis either.

### 2.6.1.3. Retrofit Elevation of Single-Family Dwellings

Retrofit elevation is one of the most common flood retrofits. This strategy consists of separating the superstructure or living space of the house from the foundation and lifting the structure to the desired elevation and then constructing a new foundation beneath it (Figure 2-33 ). This approach most commonly is applied to buildings constructed in floodplains prior to the adoption of flood risk maps. Since these houses were constructed prior to the delineation of the base flood (1-percent-annual-chance flood) they often were constructed to avoid common floods, but with lowest floor elevations above the ground similar to houses constructed outside the floodplain. This is in contrast to houses constructed after the delineation of the base flood (as shown on flood insurance rate maps – FIRMs) where locally adopted floodplain ordinances would require the house to be built with National Flood Insurance Program (NFIP) minimum requirements in Zone A to have the top of the lowest floor at or above the base flood elevation (BFE), which is nominally the elevation with 1 percent probability of being exceeded by flooding every year, and more likely than not of being flooded in a 75-year useful life of a house. A few communities require freeboard, that is, additional elevation of the first floor above the BFE. However, the present analysis only considered single-family dwellings constructed below the BFE. The project team analyzed the benefits and costs of taking existing houses originally constructed one to four feet below the BFE and elevating them to one foot above BFE.

The retrofit elevation process depends on the type of floor system. Houses with wood-framed floors, often over crawlspaces, can be elevated using a system of steel beams and lifting jacks that are slid underneath the bottom of the floor framing through holes made in the foundation (see Figure 2-34). The house is jacked to an elevation slightly above the required elevation and a new foundation is constructed. The house is then lowered onto and secured to the new foundation.

Houses with a slab-on-grade foundation are lifted in one of two manners. If the slab is unreinforced or inadequately reinforced, then the walls often are separated from the slab, the walls and roof are elevated, and a new foundation and wood framed floor system are constructed below the walls (see Figure 2-35). Houses with sufficiently reinforced slabs can be elevated as follows. Trenches are dug underneath the slab and a jacking system is used to simultaneously elevate the house and slab (see Figure 2-36). A new foundation is constructed to support the weight of the house and slab. Lifting unreinforced slab houses with the slab attached to the walls was not considered a viable mitigation option due to the risk to homeowners of using a nonstructural slab as a floor system. Unreinforced slabs are being lifted, but the project team felt that it should not evaluate unsafe mitigation practices as part of this study.



Figure 2-33: Before (left) and after (right) elevation photos for a single-family house (Source: Stacy Wright)

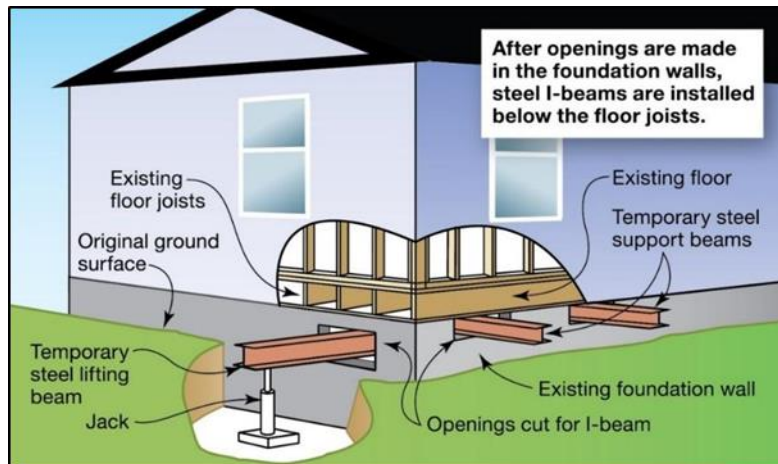
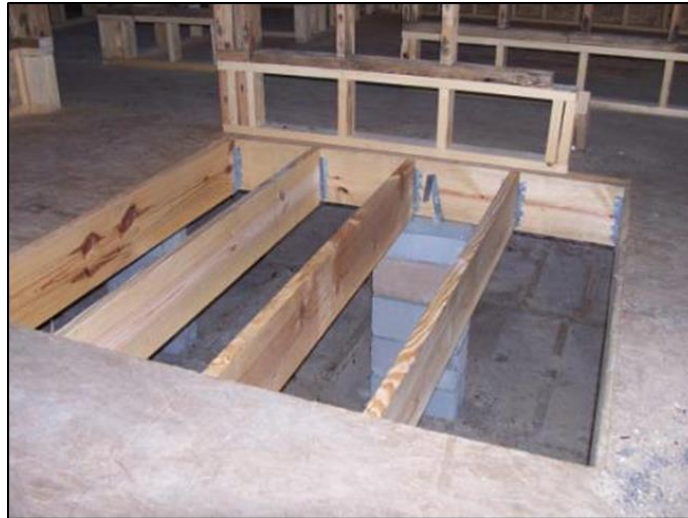

Figure 2-34: Illustration of a retrofit elevation of a wood-frame flood system house on a crawlspace (Source: FEMA P-259)



**Figure 2-35:** Examples of elevated single-family house where the walls were separated from the slab and a new wood-framed floor system was constructed (Source: John Squerciati)



**Figure 2-36:** Examples of elevated concrete slab single-family houses (Source: FEMA)

Costs for elevating houses largely depend on the type of elevation (wood-frame or slab-on-grade), amount of lifting required, and building size. Project costs to elevate wood-framed crawlspace houses averaged approximately \$65-\$75 per square foot of living space, while slab-on-grade elevations averaged approximately \$101 per square foot. Costs to elevate houses could vary more depending on accessibility of lifting equipment, availability of local contractors, and the height that the house is being elevated.

The benefits of retrofit elevation include reductions in building damage, contents damage, additional living expenses, indirect business interruption, avoided cases of PTSD, and reduced overhead and profit on flood insurance premiums. As discussed in Section 2.6.1.2, elevations do not avoid deaths because most deaths in floods occur as people try to drive to or from home on flooded roads. Making the home less likely to flood obviously does not change where people drive. Figure 2-37 provides an overview of the

## NATURAL HAZARD MITIGATION SAVES:

calculated national benefits for retrofit elevation of a percentage of the overall single-family houses constructed below the BFE. The analysis indicated that with a project useful life of 30 years and using a discount rate of 2.2 percent that the BCR for retrofit elevation would be 2:1. This BCR represents an overall average value for hundreds of houses considered for a variety of heights and flood conditions.

**Benefit: \$84 billion**

**88% – Property: \$74**

**7% – Additional living expenses: \$6**

**4% – Indirect business interruption: \$3**

**1% – PTSD: \$1**

**Billions 2018 USD**

**Cost: \$43 billion**

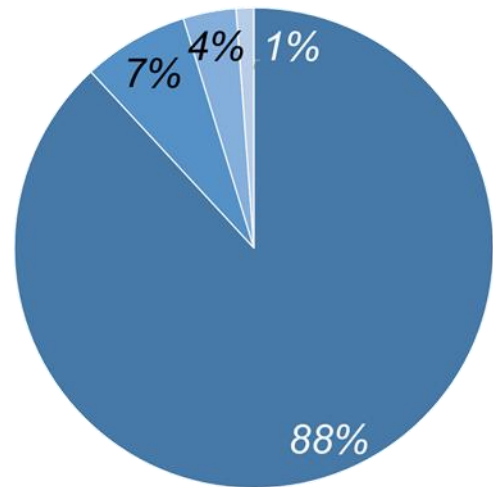

Figure 2-37: Contribution flood-related benefits from retrofit elevation of flood-prone single-family dwellings.

Individual houses may enjoy a higher BCR if the flood frequencies are greater than the average or the elevation costs are lower. While houses were studied between one and four feet below base flood elevation (BFE-1 to BFE-4), many houses have an even lower elevation. Elevating homes often is cost effective if the cost does not dramatically exceed the average used here.

### 2.6.1.4. Wet Floodproofing Basements of Single-Family Dwellings

Wet floodproofing uses a combination of flood openings and flood damage-resistant materials to create a space that when flooded will only result in cosmetic damage. This approach is commonly applied to crawlspaces and basement areas below single-family houses. Wet floodproofing alone will not bring a house into compliance with the NFIP requirements. If the lowest floor elevation is at or above the required elevation, then wet floodproofing crawlspaces can sometimes bring the house into compliance. Some owners elect to wet floodproof a crawlspace or basement (defined as a floor that is below grade on all four sides) to reduce repair costs, especially when flooding is common.

Basement areas are common in some parts of the country. When floodwaters reach openings, such as windows and access doors, the water quickly fills the basement, often with mud and contaminants. Figure 2-38 shows a house that was filled with floodwater and mud. Cleaning these areas can be costly. Cavity walls such as those built with concrete masonry units (CMU) commonly trap water, which can leak out after floodwater initially has been pumped out. A humid environment and non-flood resistant materials quickly can lead to mold growth. Discussions of how to wet floodproof areas suggest using materials that



## NATURAL HAZARD MITIGATION SAVES:

comply with FEMA NFIP Technical Bulletin 2, Flood Damage-Resistant Materials Requirements, including insulation and wall and floor coverings. The approach also calls for relocation, removal, or replacement of mechanical, electrical, and plumbing systems in the area. If the equipment is replaced instead of being relocated, the new equipment must be installed, keeping in mind being submerged in floodwater.

The installation of flood openings is another important component of wet floodproofing. Wall systems that are dry on one side and submerged on the other can succumb to hydrostatic, lateral flood loads. Using flood openings reduces this potential and allows the area to fill with water without knocking over the wall. Basements still need to be pumped out after the floodwater recedes, but this would be the case even without flood openings. This approach allows the walls to avoid the lateral loading. Figure 2-39 shows a wet floodproofed basement.



**Figure 2-38:** A man cleans mud out of his basement after the floodwaters recede. (Source: FEMA Photo Library - Photo by Liz Roll/ FEMA News Photo, Photo by Liz Roll - May 14, 1996 - Location: Mt. Gay, WV)

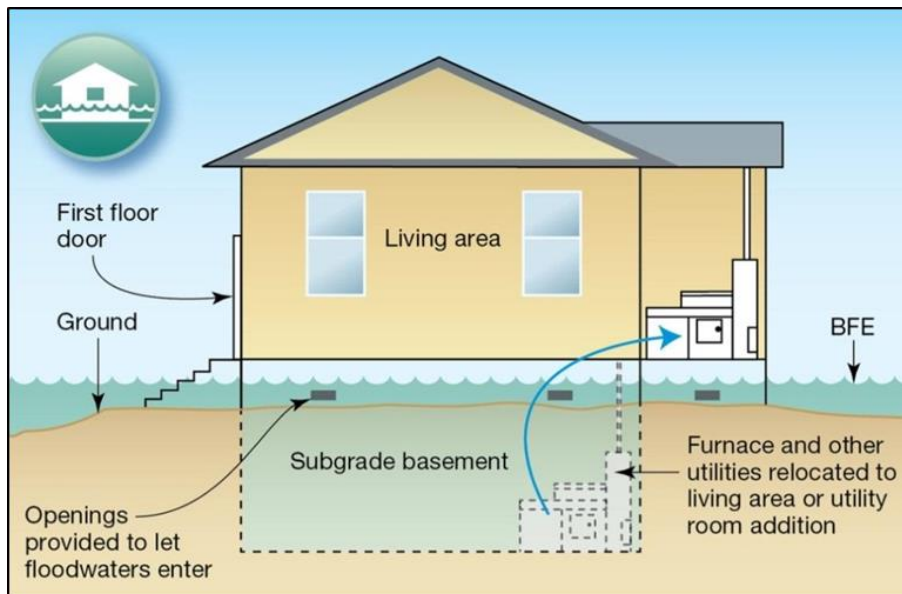

Figure 2-39: Wet floodproofed basement (Source: FEMA P-259 Figure 1-10)

Wet floodproofing costs can widely vary. This work often is completed in conjunction with the retrofits described in Section 2.6.1.5. The project team evaluated the costs to install flood openings, replace many common interior basement finishes and floor coverings with flood damage resistant materials, and incorporate an insulation that is flood-damage resistant. The project team estimated a cost of \$15.49 per square foot. Some owners may have appliances such as a clothes washer and dryer located in a basement and could require the addition of a utility closet to relocate the equipment to an upper floor. This added cost would have been difficult to estimate because of variability in house floorplans and framing requirements, so the present study assumed that room could be found on the upper floor without having to add floorspace.

Wet floodproofing a basement mostly reduces property damage. Owners likely would find that wet floodproofing of the basement would reduce the time necessary to clean up the basement. The analysis only addressed basement flooding and did not consider flooding of upper floors. This was done to focus on the costs and benefits of wet floodproofing. Since wet basements tend to require maintenance and replacement of finishes, the project team judged the useful life of wet floodproofing to be 20 years. Even with a 20-year useful life, with a discount rate of 2.2%, the BCR was 2.4:1.

## NATURAL HAZARD MITIGATION SAVES:

**Benefit: \$7.7 billion**

100% – Property: \$7.7

0% – Additional living expenses: \$0

0% – Indirect business interruption: \$0

0% – PTSD: \$0

Billions 2018 USD

**Cost: \$3.2 billion**

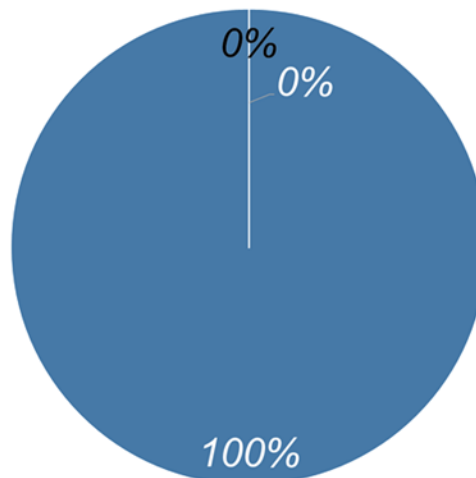

Figure 2-40: Contribution flood-related benefits from wet floodproofing basements of flood-prone single-family dwellings.

### 2.6.1.5. Utility Retrofits for Single-Family Dwellings

The project team evaluated several measures that could be taken to reduce the flood risk to equipment commonly located in basement areas, crawlspaces, or located at ground level next to houses. The term utility is used here, but it refers more narrowly to retrofitting mechanical and plumbing equipment. The primary strategy to mitigate any mechanical or plumbing equipment below the lowest floor elevation is to relocate or elevate the equipment to or above the lowest floor elevation. Two groupings were used to evaluate the cost effectiveness of utility retrofits. The first group includes elevating air conditioning units or heat pumps and relocating ductwork attached to the underside of a wood-framed floor system. The second group includes relocating a furnace or water heater from a basement or crawlspace to either an attic or the first floor.

Air conditioning units and heat pumps often are located at ground level on concrete pads. These units can be damaged by floodwater; once touched by floodwater they often are considered damaged beyond repair. Although they may be easy to replace, this can be costly. People commonly elevate them on either masonry (see Figure 2-41) or wooden platforms. The study associated this mitigation with the relocation of ductwork below a wood-framed floor system. Ductwork for single-story or first-floor areas commonly is located in basements or crawlspaces below the lowest floor; it often is the first equipment to be damaged by flood. Although people do try to clean ductwork, it is more common to remove and replace the flooded ductwork to eliminate the risk of mold and deal with saturated insulation around the ducts. For single-story houses, the ductwork usually can be relocated into the attic. This requires moving all associated equipment such as the air handler, reworking ductwork registers, and likely requires modification of return vents. Two-story houses, however, present an additional difficulty: Insufficient room between the floor joists for the second floor to run all of the ductwork because duct trunklines run

## NATURAL HAZARD MITIGATION SAVES:

perpendicular to the joists. A common approach is to construct a soffit system on the underside of the second floor to house the trunkline (see Figure 2-42).



Figure 2-41: An example of an elevated air conditioning unit. (Source FEMA P-348 – Figure 3-1)

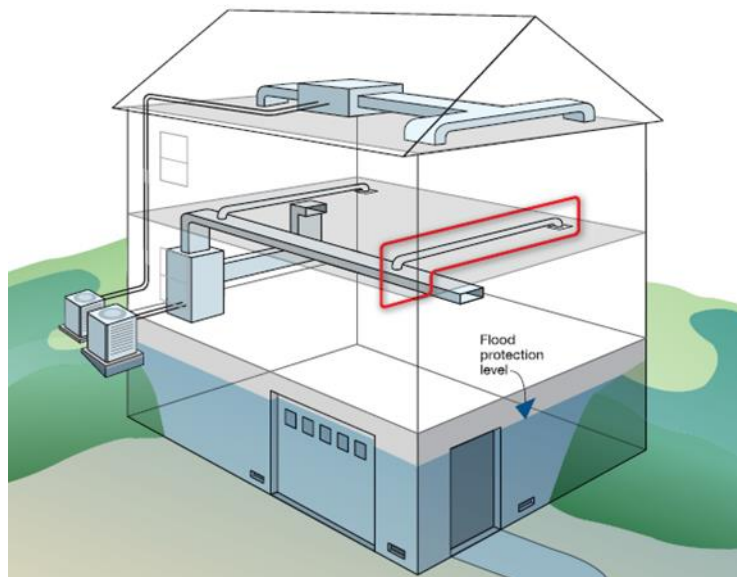

Figure 2-42: An example of elevated air conditioning units and ductwork relocated from the below the lowest floor into the soffit (the underside) of the second floor. (Source FEMA P-348 – Figure 4-6)

## NATURAL HAZARD MITIGATION SAVES:

The costs to do this work widely vary. This study used an average cost of \$5.03 per square foot to elevate air conditioning equipment and to relocate ductwork. This cost does not cover replacement of an existing air conditioning unit or heat pump, which significantly would increase the costs. The cost also does not address upgrades that owners may elect to make to achieve improved energy efficiency, but these additional costs may provide return on investment on their own.

Benefits for the elevation of equipment and relocation of ductwork only include reducing the property loss resulting from the physical damage to the outside unit and ductwork. Conceivably, the loss of heating or air conditioning could result in the family having to leave an excessively uncomfortable house, but lacking evidence that people commonly experience additional living expenses, the project team chose conservatively to ignore savings in additional living expenses. The project useful life was set to 15 years for the air conditioner or heat pump, since it is assumed owners may elect upon replacement of the unit to elevate the replacement. The ductwork relocation project useful life was set at 30 years. While ductwork commonly is replaced when new air conditioning, furnace, or heat pumps are installed, it is rare that an owner would elect to relocate the ductwork from its current location to a new location in the house. Mitigation experts noted that it also is common that even after a flood, homeowners often just replace ductwork instead of relocating it. It was therefore decided that 30 years was a more appropriate value. Using these project useful lives and a discount rate of 2.2 percent the BCR was 1.5:1.

**Benefit: \$1.1 billion**

100% – Property: \$1.1

0% – Additional living expenses: \$0

0% – Indirect business interruption: \$0

0% – PTSD: \$0

Billions 2018 USD

**Cost: \$0.7 billion**

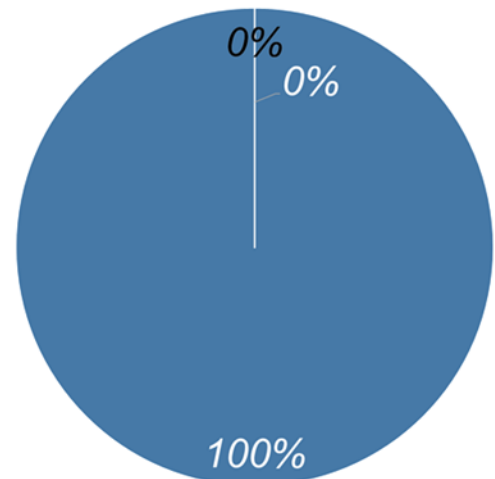

Figure 2-43: Contribution flood-related benefits from elevating air conditioning units or heat pumps and relocating ductwork for flood-prone single-family houses.

Furnaces and water heaters often are located in basements and crawlspaces for aesthetics, to minimize water damage in case of leaks, and maximize living space in the rest of the house. This does, however, leave these units prone to flood damage. Once floodwaters reach the lowest point of entry for a basement or crawlspace, the area begins to fill with water. Furnace contractors often recommend replacing a furnace that has been touched by floodwaters since there is potential risk of damage to safety systems from floodwater. Similarly, plumbers commonly recommend replacing water heaters touched by

## NATURAL HAZARD MITIGATION SAVES:

floodwater rather than trying to determine which parts should be cleaned or replaced. The present study therefore evaluated relocating these units to either attic spaces or into areas of the first floor to reduce the flood vulnerability.

The cost to relocate this equipment assumed in the present analysis included their replacement. Furnaces may require a different orientation. Water heaters have a relatively short life (approximately 10 years) and plumbers commonly recommend a new unit if it were to be relocated to a new part of the house. The project team estimated that furnace relocation costs approximately \$6.42 per square foot. Relocating a water heater was assumed to cost \$6,000. The furnace was calculated on a square foot basis since the size of the furnace required depends on the total heated space, while water heater size is not controlled so much by the size of the house and as by occupants' needs. Relocation costs include all necessary gas work, venting, electrical work, and plumbing.

The benefits include only reduced property loss, just as with relocation of the air conditioning unit and ductwork based on the same rationale. The project team took the project useful life to be 30 years. As with the ductwork, while these units likely are to be replaced more often, it is rare that owners elect to completely relocate a unit. Using this project useful life and a discount rate of 2.2%, the BCR was 2:1, as detailed in Figure 2-44.

**Benefit: \$2.7 billion**

100% – Property: \$2.7

0% – Additional living expenses: \$0

0% – Indirect business interruption: \$0

0% – PTSD: \$0

Billions 2018 USD

**Cost: \$1.2 billion**

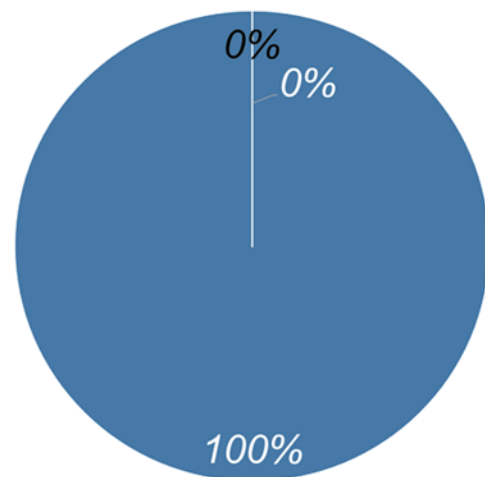

Figure 2-44: Contribution flood-related benefits from relocating water heaters and furnaces located in basements or crawlspaces for flood-prone single-family dwellings.

## 2.6.2. BCRs for Hurricane Wind Retrofit of Private-Sector Buildings

### 2.6.2.1. IBHS FORTIFIED Home Program to Existing Residential Dwellings

The scope of the study is limited to hurricane-prone regions in the mainland U.S., which per the current ASCE 7-16, is defined as the "U.S. Atlantic Ocean and Gulf of Mexico coasts where the ultimate design wind speed  $V_{ult}$ , for Risk Category II buildings is greater than 115 mph." The U.S. has an estimated 2.9

## NATURAL HAZARD MITIGATION SAVES:

million single-family dwellings located within these designated hurricane-prone regions. If all of these buildings were retrofitted to the optimal (IEMax) IBHS FORTIFIED Home designation, the current value of the expected benefit is estimated to be \$141 billion. Figure 2-46 illustrates the relative contribution to these benefits from reductions in property loss, additional living expenses, indirect business interruption, and the overhead and profit part of insurance premiums. The cost to the homeowner of the IBHS FORTIFIED Home program retrofit depends on the designation level (FORTIFIED Roof, Silver, or Gold). These expected costs will vary depending on the size, age, location and quality of the current construction. On average, expected costs will range between \$1.50 per square foot for a FORTIFIED Roof designation to \$10 per square foot for a FORTIFIED Gold designation. The cost to retrofit all existing homes in hurricane-prone regions to the optimal FORTIFIED Home designation would cost approximately \$24 billion. Given \$141 billion in benefits, the resulting BCR is approximately 6:1, e.g. \$6 saved for every \$1 spent.

The IBHS FORTIFIED Home program for retrofits of single-family residential structures is cost beneficial (BCR > 1) in all hurricane-prone regions. The results indicate that regions with higher ASCE 7-16 wind speeds (e.g. regions along the Gulf Coast, southern tip of Florida, and parts of the Atlantic Coast), have the greatest benefit-cost ratio. Figure 2-46 illustrates the optimal benefit-cost ratio per ASCE 7-16 wind band. The analysis indicates that FORTIFIED Roof is the optimal retrofit for residences located in regions where the ASCE 7-16 design wind speed is less than 120 mph. These benefits accrue from the additional protection provided by both an enhanced roof deck and water intrusion prevention. In regions with design wind speed between 120 mph and 160 mph, the optimal retrofit is FORTIFIED Silver. That designation provides the improved roof system, plus impact-rated opening protection for the building envelope. Regions with design winds between 120 mph and 160 mph have higher potential for wind-borne debris to penetrate the building envelope, which causes interior water damage and sudden increases in internal pressures that can lead to failure of weak points in the structural system. For regions where the wind speed is greater than 160 mph, the FORTIFIED Gold designation is estimated to be the optimal retrofit. These very high wind regions benefit the most from a system-wide, roof-to-foundation retrofit.

Figure 2-45 illustrates the contributions from the various benefit categories. The reduction in building and contents repair costs dominates the benefit (62% of the total), followed by additional living expenses (18%), reduction in insurance premiums (11%) and indirect business interruption (9%). As outlined in Section 4.17, only the portion of the premiums attributable to overhead and profit (O&P) of the insurance company are included among the benefits, since the portion of the premium directly covering potential losses is already accounted for.

## NATURAL HAZARD MITIGATION SAVES:

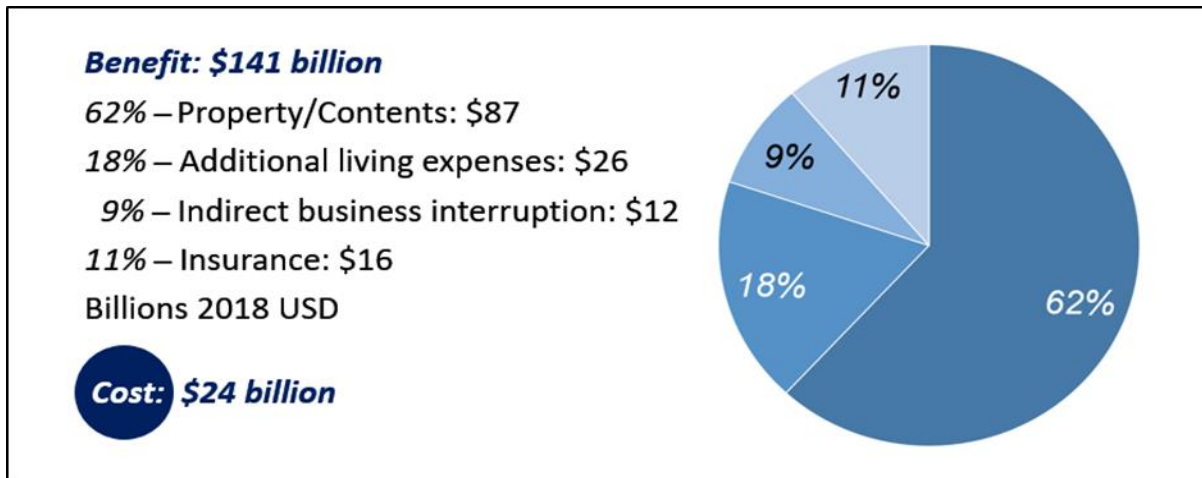

Figure 2-45: Contribution to benefits of IBHS FORTIFIED Hurricane Home retrofit for existing residential dwellings

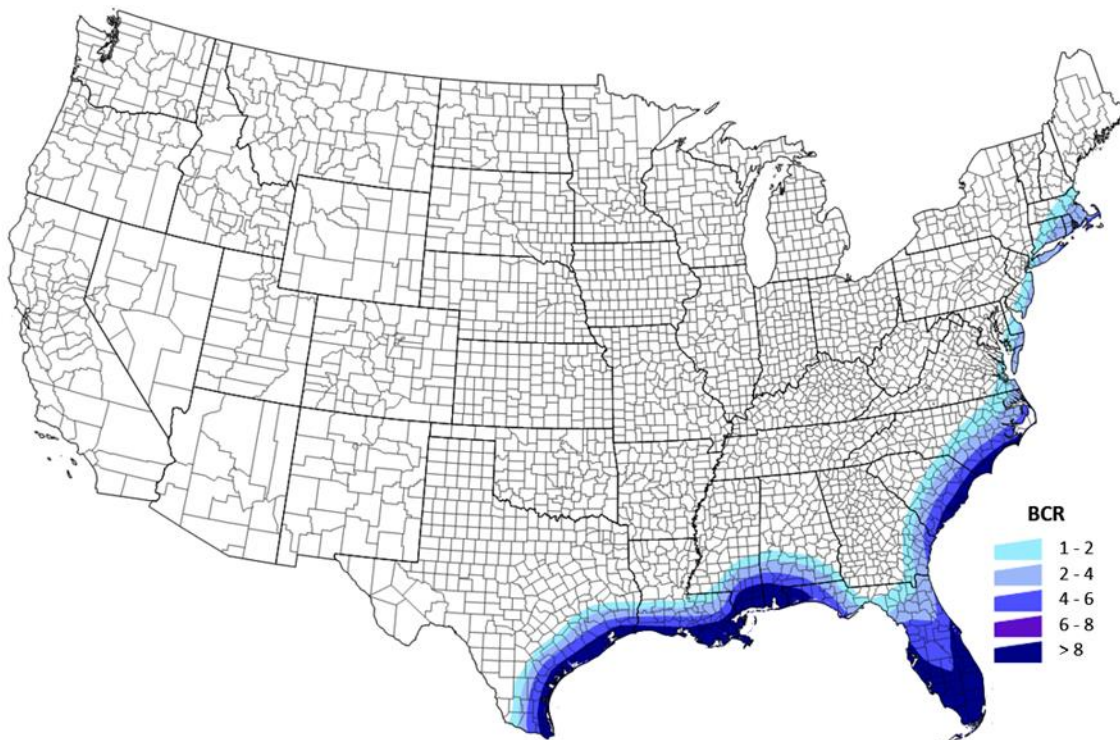

Figure 2-46: Map of BCR for IBHS FORTIFIED Hurricane Home retrofit for existing residential buildings

Table 2-14 presents the benefit-cost ratios by ASCE 7-16 design wind speed for each designation: IBHS FORTIFIED Roof, Silver, and Gold. Except for IBHS FORTIFIED Gold, all retrofit programs have benefit-cost ratios greater than 1.0 throughout the hurricane-prone regions. The relatively low cost for the IBHS FORTIFIED Roof and Silver retrofits make the initial investment very cost effective. BCRs for the FORTIFIED Roof and Silver exceed 15 where the design wind speed is equal to or greater than 160 mph. These areas,



## NATURAL HAZARD MITIGATION SAVES:

in south Florida and pockets of the Louisiana and Alabama coasts, account for approximately 5% of the population within hurricane-prone areas of the Gulf and Atlantic coasts. Some of these locations already are subject to stricter requirements in a local code (e.g., Florida’s Miami-Dade and Broward Counties), although this study does not consider local codes. There is a slight dip in BCRs where both the 700-year wind speed is 130 mph and distance from the coast is less than a mile. This is because of wind-borne debris provisions in recent building codes. For newer construction, benefits from the IBHS Silver opening protection requirements are not considered, as these requirements already are standardized in the building code.

FORTIFIED Gold is estimated to have a benefit-cost ratio greater than 1.0 in regions where the design wind speed is equal to or greater than 130 mph. The mandatory roof-to-foundation retrofits, in addition to the prerequisite requirements for FORTIFIED Roof and Silver, provide additional resistance in these high wind regions. For regions where the design wind speed is less than 130 mph, the cost exceeds the expected present value of avoided future losses, but there are other reasons to implement FORTIFIED Gold. Some homeowners might want it for additional protection and peace of mind, which we were unable to quantify in economic terms, and therefore do not contribute to the benefit-cost ratios calculated here. For an example, see the fact sheet entitled “A Case Study in Above-Code Design from Hurricane Michael.”

**Table 2-14:** BCR per wind band for the FORTIFIED IEMax, Roof, Silver and Gold IBHS Designation

700-year wind speed (mph)	IEMax FORTIFIED Program	IEMax FORTIFIED BCR	FORTIFIED Roof BCR	FORTIFIED Silver BCR	FORTIFIED Gold BCR
115	Roof	1.5	1.5	1.0	0.3
120	Silver	2.5	2.5	2.5	0.7
130 (>1 mile coast)	Silver	5.8	5.4	5.8	1.9
130 (<1 mile coast)	Silver	4.8	5.0	4.8	1.6
140	Silver	8.7	6.8	8.7	2.9
150	Silver	13.3	9.0	13.3	4.5
160	Gold	9.1	17.0	20.0	9.1
170	Gold	11.4	20.0	25.0	11.4
180	Gold	14.9	28.0	28.0	14.9

### 2.6.2.2. Add Engineered Tie-Downs to Manufactured Housing

An engineered tie-down system (ETS) for manufactured housing comprises straps attached at one end to the frame of the manufactured home and at the other end to an anchor that is screwed into the ground. (Another variant called over-the-top tie-downs has straps that are placed over the siding and roof.) The

## NATURAL HAZARD MITIGATION SAVES:

straps are spaced four to five feet apart. The system provides what engineers call “positive connection” between the manufactured home and ground. An ETS helps in both earthquake- and hurricane-prone regions. High winds or the side-to-side motion of the ground in earthquakes can cause unstrapped manufactured homes to slide off their support piers or overturn. Engineered tie-down systems help to reduce that risk, the same way tent pins reduce the risk of a tent blowing away in strong winds.

Manufactured homes currently are constructed in accordance with the Manufactured Home Construction and Safety Standards (also known as the HUD Code), which was established in 1976. Manufactured homes built prior to 1976 did not meet these standards and tend to be fragile, whether connected to the ground or not, too fragile for the ETS to make much difference. The present analysis therefore is limited to manufactured homes built after 1976. Per the current HUD Code, anchorage must be installed in accordance with Subpart E – Anchorage Against Wind. The type of anchorage is dependent on the location of the manufactured home, as design wind speeds and HUD wind zones (I, II, and III) vary. The anchorage system is comprised of diagonal (and vertical for HUD Wind Zones II and III) straps that attach to the chassis of the home and are anchored to the ground via an auger or drive anchor.

Engineered tie-downs are estimated to have a benefit-cost ratio greater than 1.0 in 193 hurricane-prone counties along the Gulf and Atlantic coasts. Expected benefits total approximately \$772 million at a cost of \$194 million, i.e., saving approximately \$4 per \$1 invested. Figure 2-47 illustrates the contributions from the various benefit categories: building and contents repair costs (66%), reduced insurance overhead and profit (16%), savings from additional living expenses (12%), and savings from indirect business interruption (6%). Figure 2-48 illustrates the calculated BCR by county. Properties located in regions with higher ASCE 7-16 wind speeds benefit more than those further inland and along the northeast coast. Even where engineered tie-downs have a benefit-cost ratio less than 1.0, they may be warranted in a variety of conditions for post-1976 manufactured housing, especially because of the peace of mind they can provide, which could not be quantified here among the benefits.

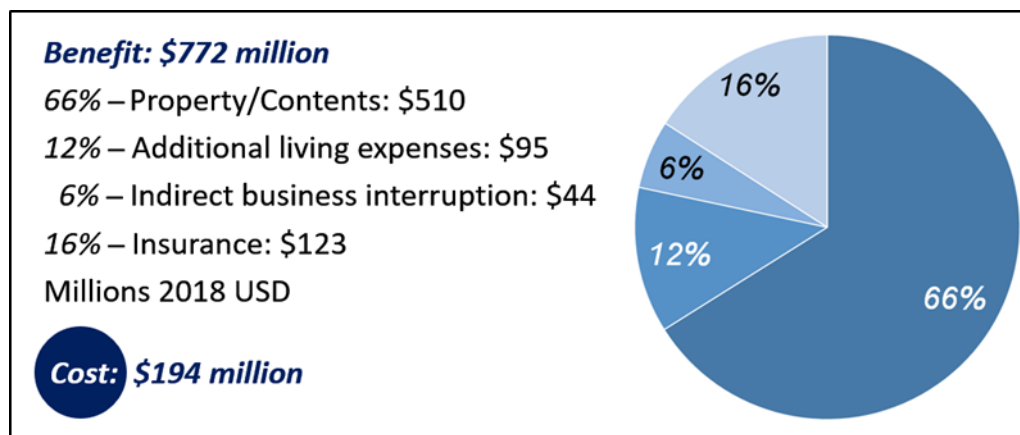

Figure 2-47: Contribution to hurricane wind-related benefits from engineered tie-down systems for manufactured housing.

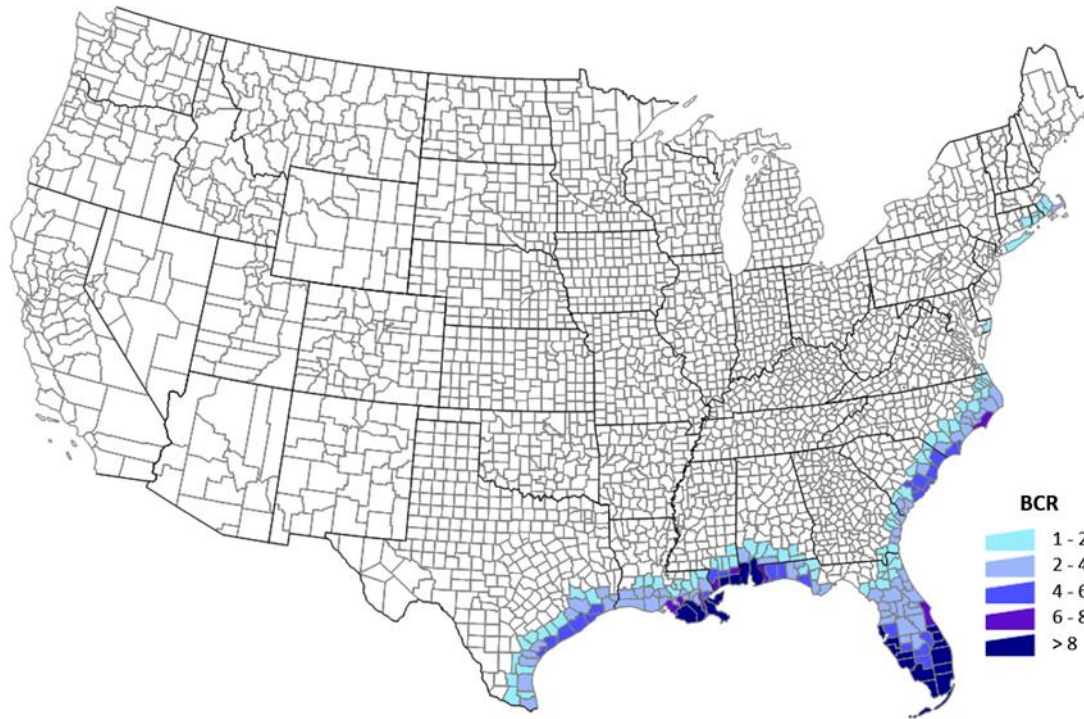

Figure 2-48: Map of hurricane wind-related BCR from engineered tie-down systems for manufactured housing.

### 2.6.3. BCRs for Seismic Retrofit of Private-Sector Buildings

#### 2.6.3.1. Add Cantilever Columns and Wood Shearwalls to Soft-Story Wood-Frame Multifamily Dwellings

“Soft story” usually refers to the ground story in a multistory building having significantly less strength, stiffness, or both, than stories above. In the case of multifamily dwellings, the condition often arises because the ground story is used for parking and the exterior walls are more open to accommodate garage doors and building entrances, as illustrated in Figure 2-49. The condition makes such buildings prone to collapse, as happened in the 1989 Loma Prieta and 1994 Northridge earthquakes, among others. See Figure 2-50 for examples. A public advisory committee acting on behalf of the City of San Francisco as part of the city’s Community Action Plan for Seismic Safety recommended the use of a retrofit involving the additions of steel cantilever columns to ground-floor garage openings and structural sheathing (plywood or oriented strandboard) to interior walls of the ground story, as shown in Figure 2-51.

## NATURAL HAZARD MITIGATION SAVES:



Figure 2-49: Soft-story wood-frame multifamily dwellings. (A) Menlo Park, California. (B) Pasadena, California. (Photo credit: Porter 2006, used with permission.)



Figure 2-50: Examples of collapsed soft-story wood-frame multifamily dwellings. (A) Collapsed apartment buildings in the San Francisco Marina District after the 1989 Loma Prieta earthquake (Image credit: R.B. Seed, 1989, via UC Berkeley NISEE, with permission). (B) Apartment building collapse after 1994 Northridge earthquake, associated with soft-story conditions (Image credit: UC Berkeley NISEE, 1994, with permission).

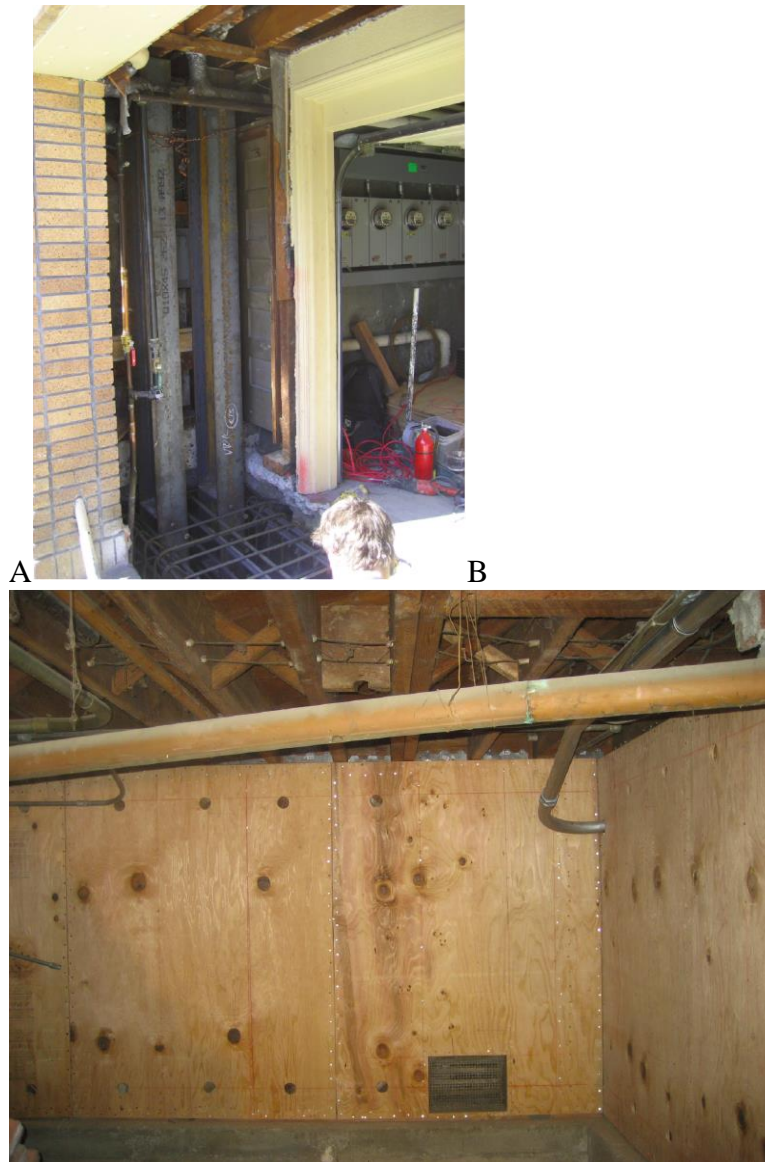

**Figure 2-51:** Retrofit for soft-story wood-frame multifamily dwelling. (A) Cantilever columns added to garage openings, and (B) structural sheathing added to ground-story walls to strengthen soft-story multifamily wood-frame dwellings (Image credit: Applied Technology Council, with permission)

The cost of such a retrofit ranges between \$4.40 and \$10.60 per square foot of building area, with an estimated average of \$8.60 per square foot. The U.S. has an estimated 4.5 billion square feet of soft-story wood-frame multifamily dwellings worth roughly \$500 billion in building replacement cost and housing 8.5 million people. If owners were to retrofit every such building in the U.S. that was cost effective to retrofit -- approximately 40% of the total -- the nationwide retrofit cost would be \$16 billion. Doing so would avoid \$190 billion in future losses, producing a BCR of 12:1.

Figure 2-52 shows the contribution to benefits from reductions in property loss, deaths, nonfatal injuries, instances of post-traumatic stress disorder, additional living expenses, and indirect business interruption.

## NATURAL HAZARD MITIGATION SAVES:

Not shown in the figure is a small reduction (\$1 million) in urban search and rescue costs. The retrofit would avoid 100 deaths and 3,800 injuries over the span of 75 years. The number of deaths seems to be the right order of magnitude in comparison with 2 deaths in the San Francisco Marina District in the 1989 Loma Prieta earthquake and 16 deaths in the collapse of the Northridge Meadows apartment complex in the 1994 Northridge earthquake. Retrofit would be cost effective for 3.6 million occupants in 1.4 million housing units, or for about 40% of the nation's occupants of such buildings (which are disproportionately built in the Western U.S.). Figure 2-53 shows that BCR tends to be higher in places with higher seismicity, with BCRs in many California counties exceeding 16:1.

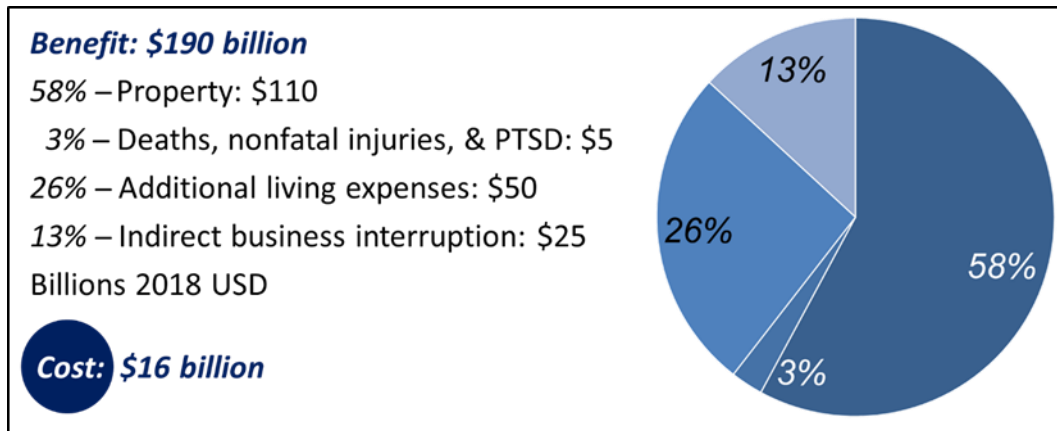

Figure 2-52: Contribution to benefits of retrofitting soft-story wood-frame multifamily dwellings.

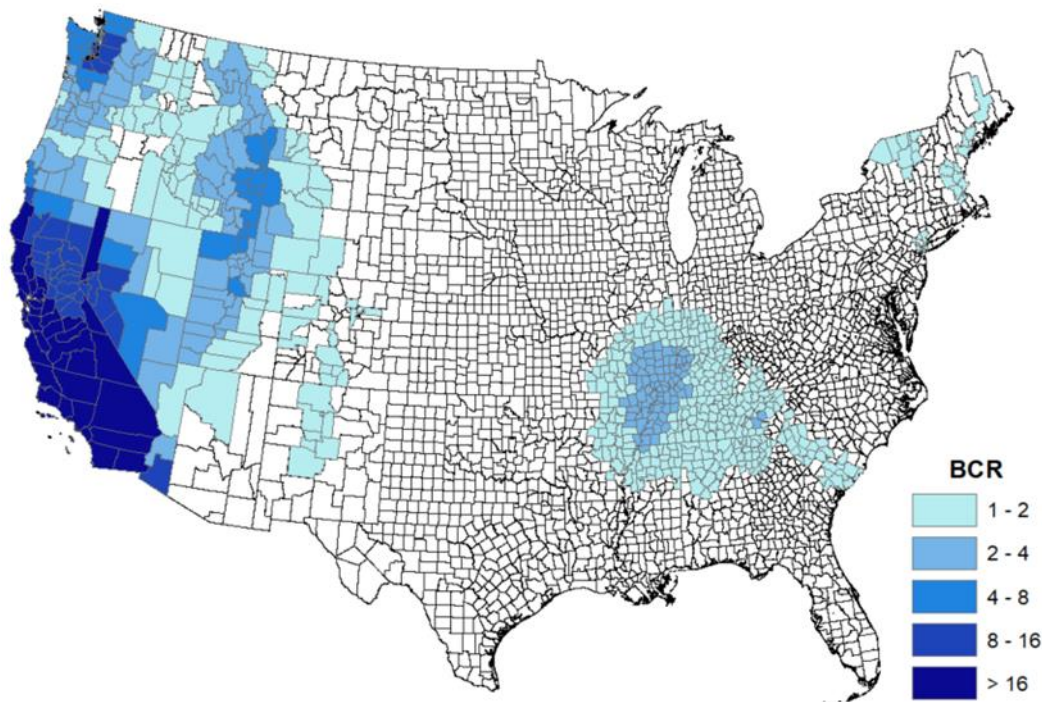

Figure 2-53: Map of BCR for retrofitting soft-story wood-frame multifamily dwellings.

### 2.6.3.2. Add Engineered Tie-Downs to Manufactured Housing

Earthquakes threaten older manufactured homes that are not secured to the ground with a foundation that resists sideways motion; this is known as sidesway. Many older manufactured homes rest on slender supports that overturn in earthquakes (Figure 2-54). Collapse injures occupants and damages homes, contents, water heaters, and utilities. Collapse also can render exits unsafe, especially for occupants fleeing fire.

Engineered tie-down systems (ETS) can be added to provide positive anchorage and lateral resistance of homes, greatly reducing the chance of collapse from sidesway. An engineered tie-down system involves the addition of a taut cable or strap that attaches the chassis of the manufactured home to an anchor that resembles a screw fixed in the ground, as illustrated in Figure 2-55. Such an anchor is attached every 6 ft or so around the perimeter of the manufactured home. The diagonal cable largely prevents the manufactured home from swaying to either side, greatly reducing the chance of collapse. The addition costs about \$1,000 to \$2,000 per dwelling. ETS parts generally are made of galvanized steel but corrode within a few decades; they are taken here to have a design life of 30 years.



**Figure 2-54:** Earthquake damage to manufactured housing. (A): Overturned concrete piers that supported a manufactured house, viewed after the 1978 Santa Barbara earthquake. (B) and (C): Collapsed manufactured houses after the 1980 Livermore earthquake. (Images courtesy of National Information Service for Earthquake Engineering, University of California, Berkeley.)

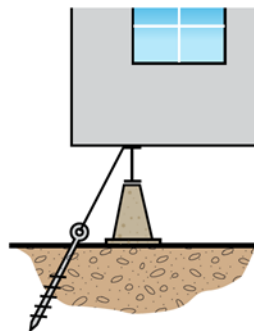

**Figure 2-55:** Schematic illustration of an engineered tie-down system of manufactured housing. (Image by Henderson Consulting, 2013, used with permission from SPA Risk LLC.)

## NATURAL HAZARD MITIGATION SAVES:

Before considering the dual benefit that ETS provide in places that are subject to hurricanes and earthquakes, ETS appear to be cost effective in 76 counties with 140,000 unanchored housing units occupied by 380,000 people, saving \$690 million at a cost of \$210 million, i.e., saving approximately \$3 per \$1 invested. If ETS were added everywhere that they are cost effective, 11,000 earthquake-induced collapses would be avoided, preventing the displacement of 25,000 people. Figure 2-56 shows the sources of benefits. Figure 2-57 shows how BCR varies geographically, with the highest BCRs appearing in places with high seismicity.

### **Benefit: \$690 million**

49% – Property: \$340

21% – Additional living expenses: \$150

11% – Indirect business interruption: \$70

19% – Deaths, nonfatal injuries, & PTSD: \$130

Millions 2018 USD

**Cost: \$210 million**

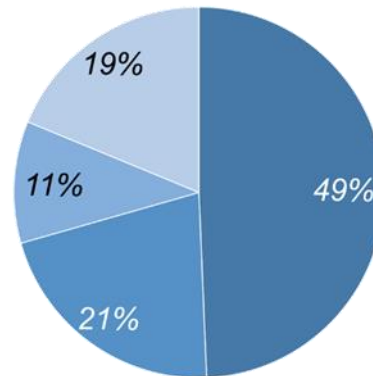

Figure 2-56: Contribution to earthquake-related benefits from engineered tie-down systems for manufactured housing.

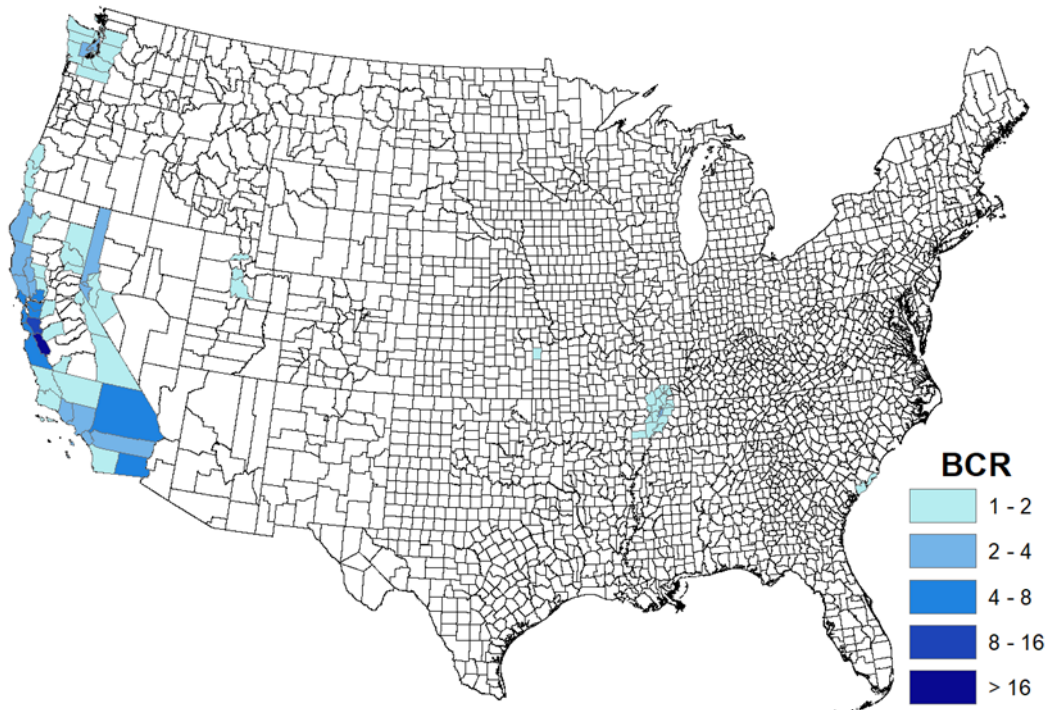

Figure 2-57: Map of earthquake-related BCR from engineered tie-down systems for manufactured housing.



## 2.6.3.3. Secure Residential Furnishings, Fixtures, Equipment, and Contents

Table 2-15 presents BCRs as well as costs, benefits, and extent of places where it is cost effective to secure residential furnishings, fixtures, equipment, and contents. The table shows that the measures examined here could benefit up to approximately 60 million U.S. households in up to 1,100 U.S. counties. The benefits of all five categories sum to approximately \$115 billion in avoided losses, at a total mitigation cost of approximately \$9 billion, for an overall BCR of 16:1. The mitigation measures could avoid 1.3 million cases of post-traumatic stress disorder, approximately 6.5 million nonfatal injuries, and 245,000 fatalities.

**Table 2-15:** Summary of benefits and costs of mitigation for residential furnishings, fixtures, equipment, and contents.

	Water heaters	Cabinet latches	Bookcases	Monitors, TVs	Fragile objects	Total
BCR	24	8	13	2	3	16
Cost per household	\$70	\$60	\$70	\$40	\$35	
Benefit per household	\$1,650	\$500	\$900	\$80	\$100	
Useful life (years)	10	50	9	9	9	
Counties with BCR > 1	1136	262	652	29	68	
Households with BCR > 1, million	59	22	32	11	15	
Cost \$million	\$4,100	\$1,400	\$2,200	\$450	\$520	\$8,700
Benefit \$million	\$98,000	\$11,400	\$28,000	\$850	\$1,600	\$140,000
PTSD cases avoided	1,300,000	0	0	0	0	1,300,000
Injuries avoided	1,300,000	0	5,200,000	0	0	6,500,000
Avoided fatalities	245,000	0	0	0	0	245,000

Figure 2-58 shows the contributions to the benefits resulting from securing hot water heaters to the building frame. The mitigation measure produces most of its benefits through avoided fire losses. Avoided property losses alone represent 12 times the cost of the mitigation measure. Figure 2-59 shows the geographic extent of places in the contiguous 48 states where the mitigation measure is cost effective: essentially everywhere with moderate to high seismicity.

## NATURAL HAZARD MITIGATION SAVES:

### **Benefit: \$98 billion**

42% – Property: \$41

5% – Additional living expenses: \$5

3% – Indirect business interruption: \$3

50% – Deaths, nonfatal injuries, & PTSD: \$49

Billions 2018 USD

**Cost: \$4.1 billion**

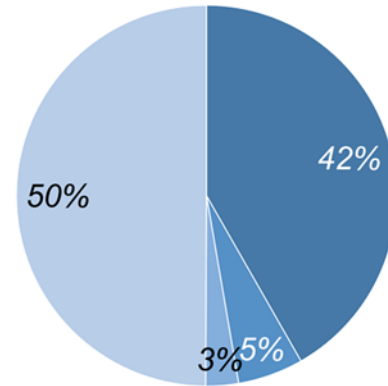

Figure 2-58: Contribution to benefits of securing hot water heaters to the building frame.

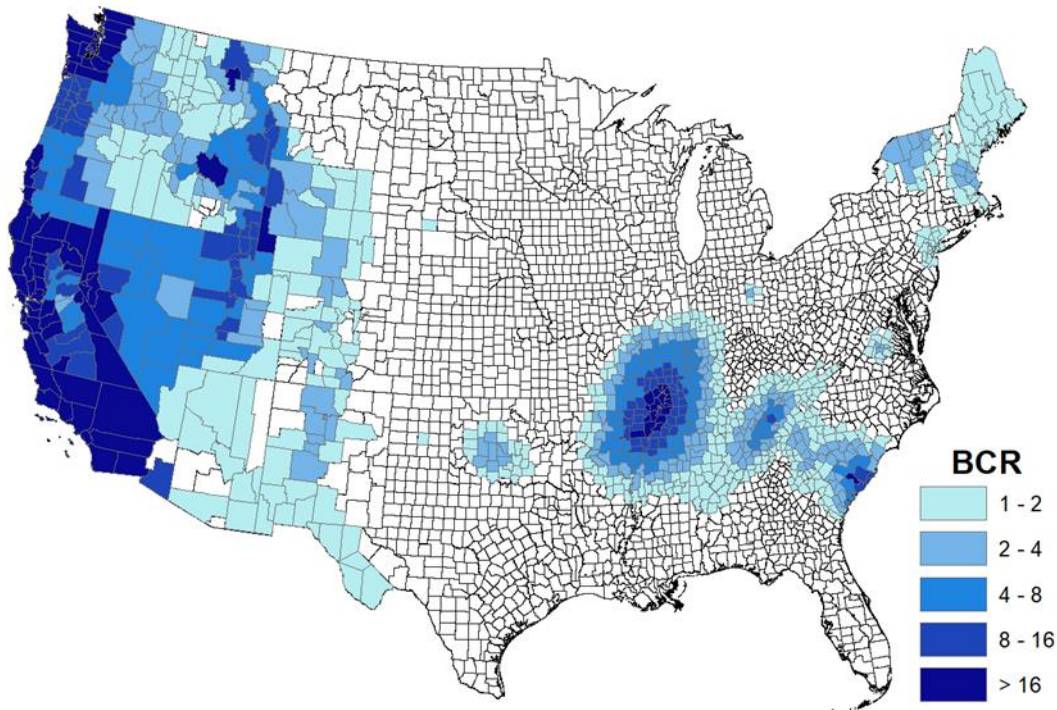

Figure 2-59: Map of BCR from securing hot water heaters to the building frame.

Figure 2-60 shows the contributions to the benefits resulting from adding safety latches to the doors of kitchen cabinets that contain fragile items. The mitigation measure produces most of its benefits by protecting the items in the cabinets. The time-element benefits—additional living expenses and indirect business interruption—represent the avoided labor cleaning up the mess. Figure 2-61 shows that the mitigation measure is cost effective in regions of high seismicity.

## NATURAL HAZARD MITIGATION SAVES:

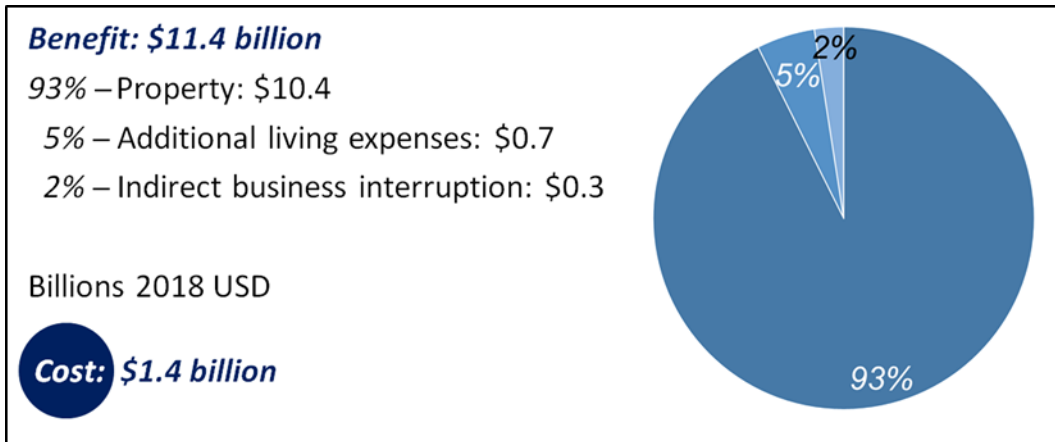

Figure 2-60: Contribution to benefits of adding kitchen cabinet latches.

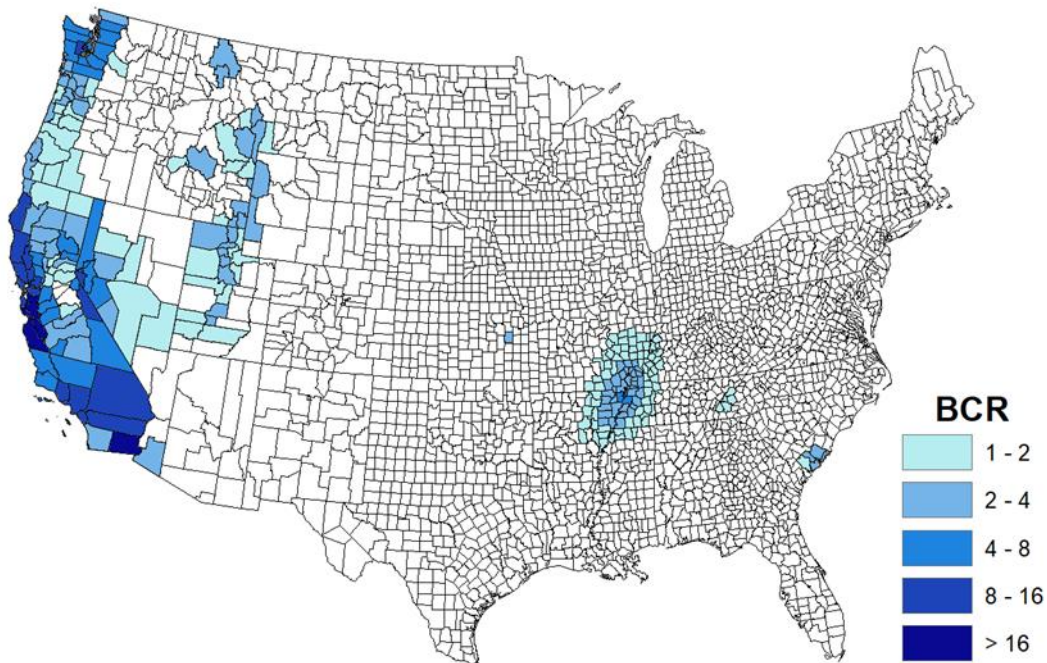

Figure 2-61: Map of BCR from adding kitchen cabinet latches.

Figure 2-62 shows that the benefits resulting from securing bookcases to the building frame come entirely from avoiding the injuries that result when bookcases fall on people. (The value of the time required to upright the bookcase and place books back in it are negligibly small in comparison.) Figure 2-63 shows that the mitigation measure is cost effective in the regions of high seismicity.

## NATURAL HAZARD MITIGATION SAVES:

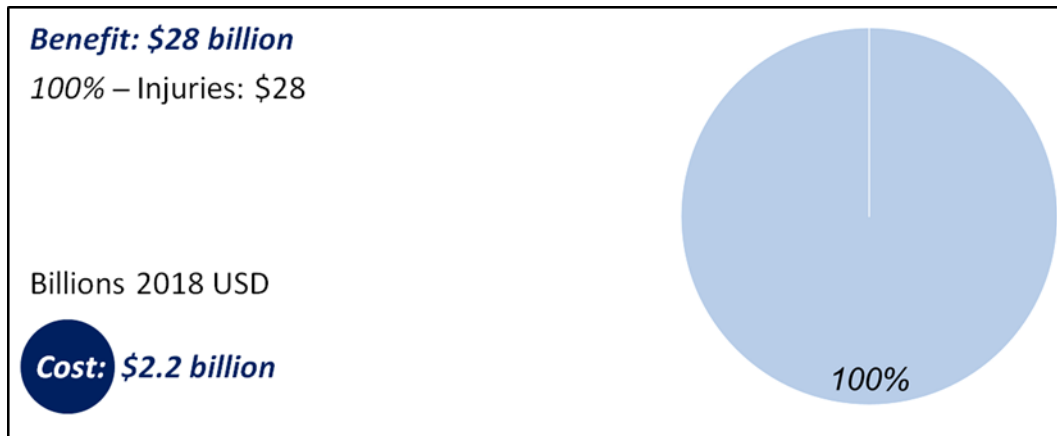

Figure 2-62: Contribution to benefits of securing bookcases to the building frame.

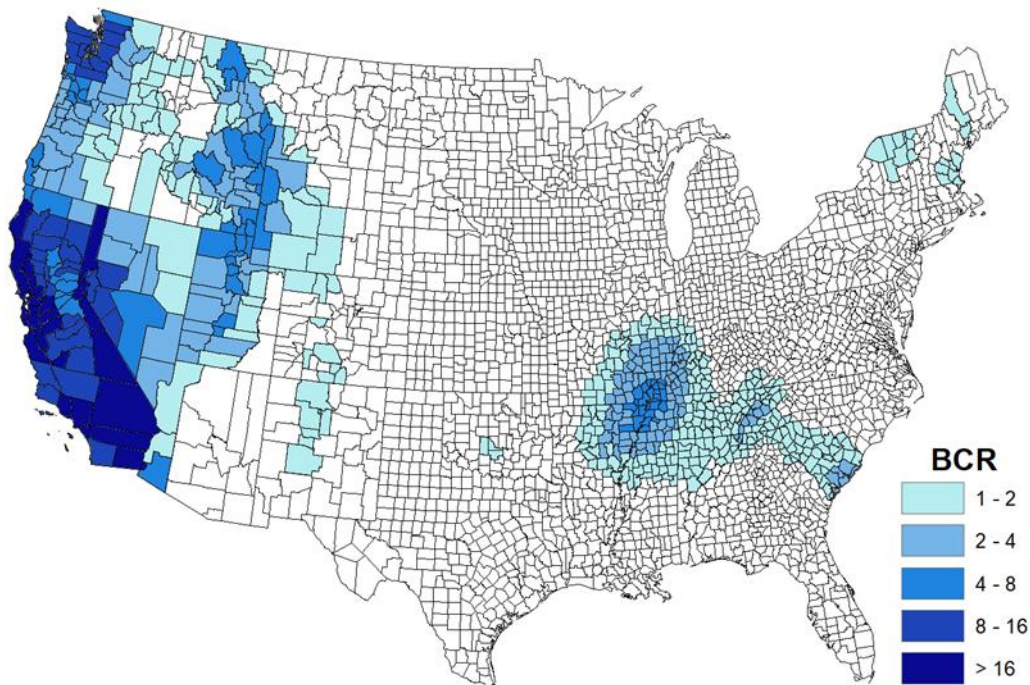

Figure 2-63: Map of BCR from securing bookcases to the building frame.

Figure 2-64 shows that the benefits resulting from strapping freestanding monitors and televisions to a desk or wall come mostly from the avoided cost to replace the damaged equipment; the remainder is the direct and indirect value of cleanup time. Figure 2-65 shows that the mitigation measure is cost effective only in the California counties with the highest seismicity.

## NATURAL HAZARD MITIGATION SAVES:

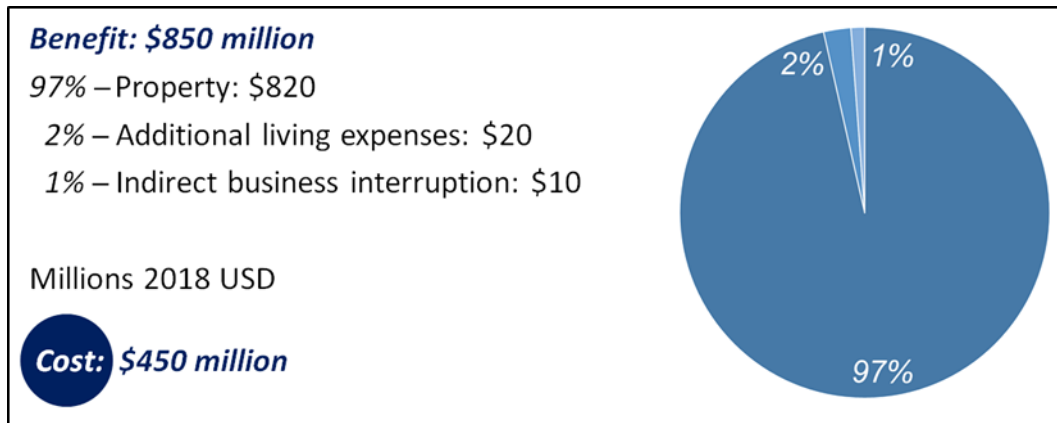

Figure 2-64: Contribution to benefits of strapping freestanding monitors and televisions.



Figure 2-65: Map of BCR from strapping freestanding monitors and televisions.

Figure 2-66 shows that the benefits resulting from securing fragile items to shelves with museum putty come mostly from the avoided cost to replace the damaged items; the remainder is the direct and indirect value of cleanup time. Figure 2-67 shows that the mitigation measure is cost effective only in counties in California, Washington, and a few counties very close to the New Madrid Seismic Zone in the central United States with the highest seismicity.

## NATURAL HAZARD MITIGATION SAVES:

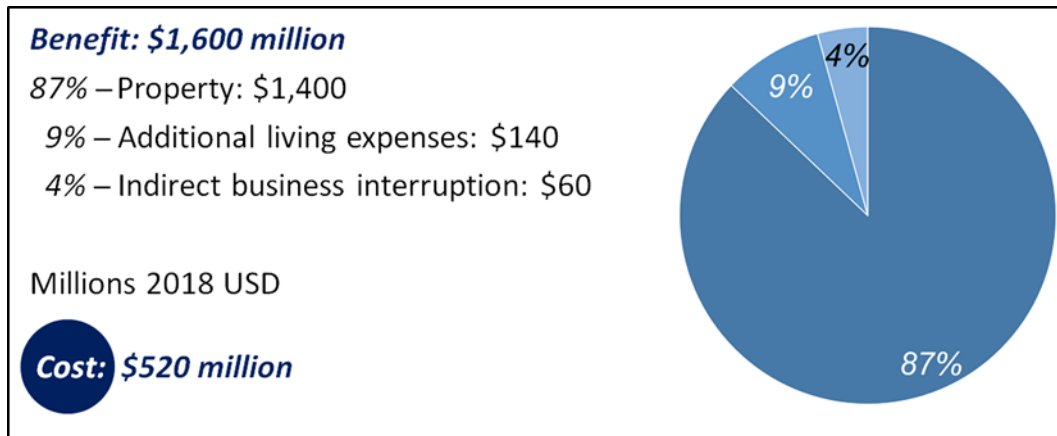

Figure 2-66: Contribution to benefits of securing fragile objects with museum putty.

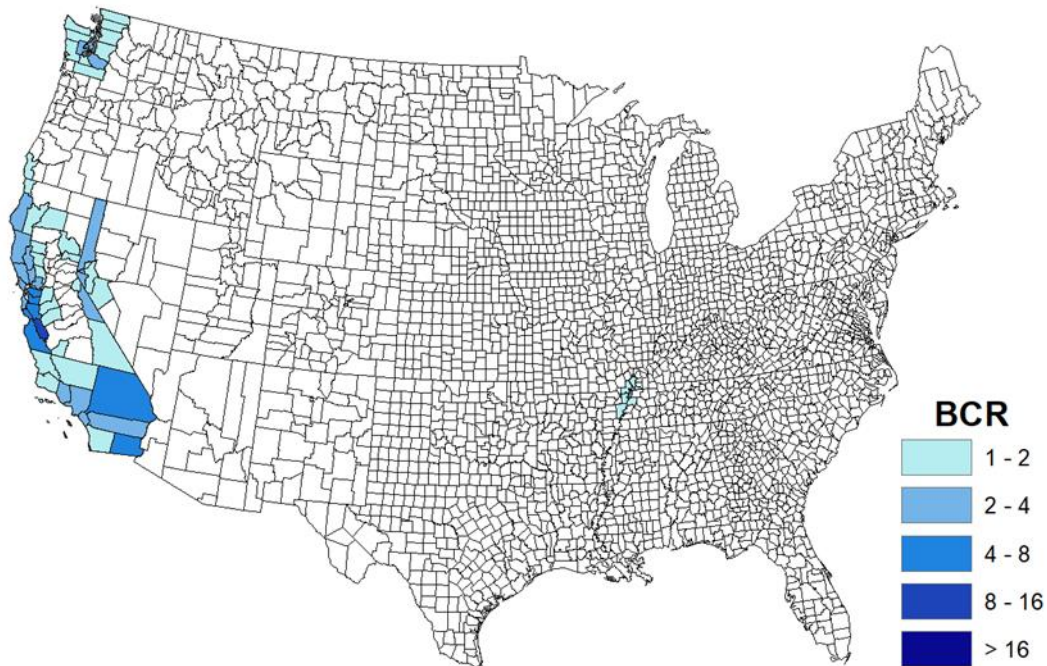

Figure 2-67: Map of BCR from securing fragile objects with museum putty.

### 2.6.4. BCRs for WUI Fire Retrofit of Private-Sector Buildings

The measure considered for WUI fire is the retrofit of existing private-sector buildings to comply with the International WUI Code. As with new construction, we only examine a detached single-family dwelling, as it represents the great majority of buildings in WUI zones as well as many other types of buildings not differing all that much in their fire vulnerability in major WUI fires (Figure 2-68).



**Figure 2-68:** (A) Houses and (B) commercial buildings burned in the 2017 Tubbs Fire. (Image credits: (A) Frank Schulenberg 2017, (B) ATS 2017, both CC BY-SA 4.0)

To make a typical house comply with requirements for class-1 ignition-resistant construction as defined in the 2018 International Wildland-Urban Interface Code (International Code Council 2017), one must replace the building cladding, enclose underfloor areas, and protect eaves and soffits with a 1-hour fire-resistance-rated construction. One must replace windows with “tempered glass, multilayered glazed panels, glass block or have a fire protection rating of not less than 20 minutes;” replace doors to achieve a fire protection rating of not less than 20 minutes; install automatic sprinklers; and in some cases, enhance the water supply. It is common (though not universal) for existing homes to already have a class-A roof as defined in Section 1505.6 of the 2018 International Building Code, so no cost is assigned to replace the roof and retrofit of roof valleys. It similarly is assumed that gutters and downspouts are made of non-combustible materials and do not require replacement and that the building already has adequate access for fire apparatus, so no access retrofit costs are assumed.

The project team conservatively estimated the present value of the cost to implement these retrofit measures for a typical 2,000-square-foot existing house to be \$72,000 (2018 USD) on average. Retrofitting an existing house to comply with the 2018 International Wildland-Urban Interface Code costs much more than achieving compliance for new construction because retrofit involves removing and replacing of much of the building envelope, as opposed to building the house to be fire resistant in the first place. Much of the initial, cheaper, less fire-resistant, construction effort is wasted if one wants to achieve better fire resilience after the initial development is finished.

Figure 2-69 shows the benefit-cost ratio for WUI fire retrofit, by county. Warmer colors indicate a higher benefit-cost ratio. Counties are shaded to indicate the highest BCR within the county boundary; many places in the shaded counties are not within the wildland-urban interface.

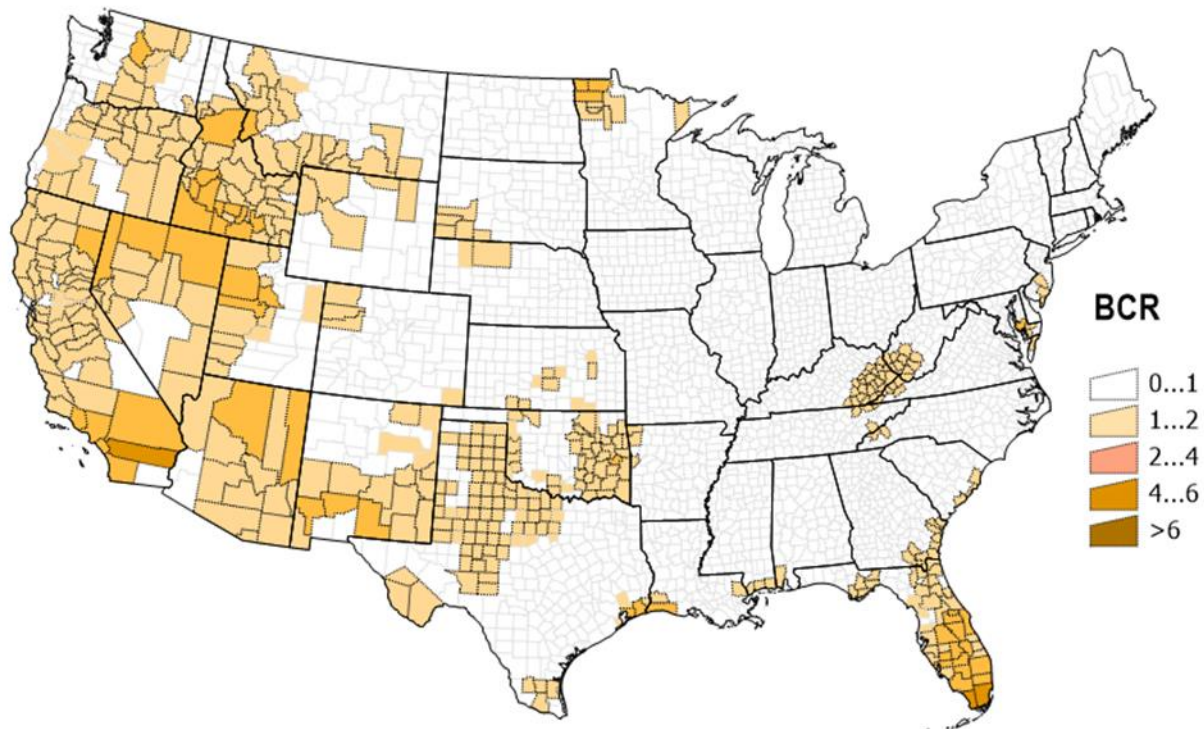

Figure 2-69: BCR of WUI fire retrofit to comply with 2015 IWUIC for existing buildings, by county.

Approximately 2.45 million households in the U.S. at risk of wildland-urban interface fire have a WUI retrofit BCR equal to or greater than 1.0. Many more households face WUI fire risk, but have lower BCRs, for example because the fire hazard is low. The total property value (structure plus contents) for these households plus nearby non-residential buildings (stores, schools, etc.) is \$1.3 trillion. The total cost of retrofitting this building stock (residential and nonresidential) to comply with the International Wildland-Urban Interface Code would be \$240 billion (18% of the value at risk). If all of these homes and other buildings were retrofitted to comply and if the retrofit were maintained during the life of the property (especially by maintaining vegetation), the present value of avoided future losses would total approximately \$430 billion, equivalent to a national average BCR of 2:1. Figure 2-70 presents a breakdown of benefits by category.

The \$430 billion in benefits accrues over the estimated life of the structure (75 years), so it equates with an annual national benefit of \$5.7 billion. As a fraction of value at risk, the figure of \$5.7 billion per year equates with a pure premium of 0.4% per year, or \$4.00 per \$1,000, roughly equivalent to the cost of fire insurance. (Pure premium is an insurance term that refers to the portion of the insurance premium that the insurer expects to pay to the insured in claims, plus the administration cost of paying claims.) That is, given the average BCR of 2:1, retrofitting to comply with the International Wildland-Urban Interface Code is equivalent to cutting the cost of fire insurance in half.



## NATURAL HAZARD MITIGATION SAVES:

**Benefit: \$430 billion**

93% – Property: \$400

4% – Deaths, nonfatal injuries, & PTSD: \$17

2% – Additional living expenses: \$9

1% – Indirect business interruption: \$4

Billions 2018 USD

**Cost: \$240 billion**

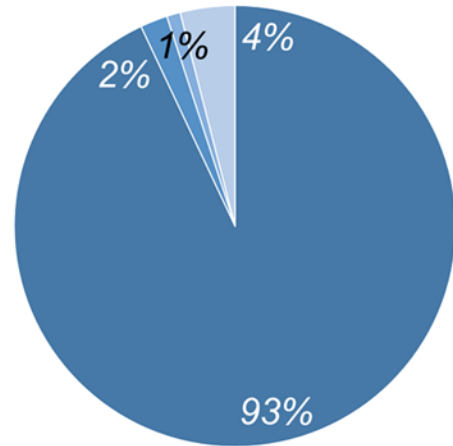

Figure 2-70: Contribution to benefits from retrofitting buildings to comply with the 2018 International Wildland-Urban Interface Code.

Note that the per-house retrofit cost is highly uncertain; it realistically could be as low as \$16,000 on average, implying a much higher benefit-cost ratio, perhaps as high as 8:1. See Section 5.15 for details.

## 2.7. AGGREGATE BENEFITS AND COSTS

The project team identified a methodology to estimate aggregate benefits and costs associated with the mitigation strategies. Table 2-16 recaps the costs and benefits presented earlier in this chapter, in terms of billions of dollars and BCR. Again, the rows for exceeding I-Code requirements for 1 year refer to the overall long-term costs and benefits accruing from 1 year of new construction of new buildings to exceed I-Code requirements, not the benefits associated with 1 year of reduced risk. However, as each additional year of construction is implemented, the cost and benefit amounts will increase, with the overall BCR likely to remain close to the same, barring changes in any of the variables.

If all new buildings were built to the IEMax design to exceed 2015 I-Code requirements for 1 year, new construction would save approximately \$4 in avoided future losses for every \$1 spent on additional, up-front construction cost. The project team determined the total costs and benefits for 1 year of design to exceed 2015 I-Code requirements by totaling the benefits and costs of the 5 mitigation categories in Table 2-16. Figure 2-71 shows the contributions to the calculation of these benefits.

## NATURAL HAZARD MITIGATION SAVES:

Table 2-16: Costs and benefits associated with constructing new buildings in 1 year to exceed 2015 I-Code requirements (in \$ billions).

Mitigation category	Cost (billions)	Benefit (billions)	BCR
Exceed 2015 I-Code requirements for riverine flood for 1 year	\$0.91	\$ 4.30	5
Exceed 2015 I-Code requirements for hurricane surge for 1 yr	\$0.01	\$ 0.05	7
Exceed 2015 I-Code requirements for hurricane wind for 1 year	\$0.81	\$ 4.20	5
Exceed 2015 I-Code requirements for earthquake for 1 year	\$1.20	\$ 4.30	4
Comply with 2015 International IWUIC Code for 1 year	\$0.80	\$ 3.00	4
<b>Total, 1 year of design exceeding 2015 I-Code</b>	<b>\$3.7</b>	<b>\$15.9</b>	<b>4</b>

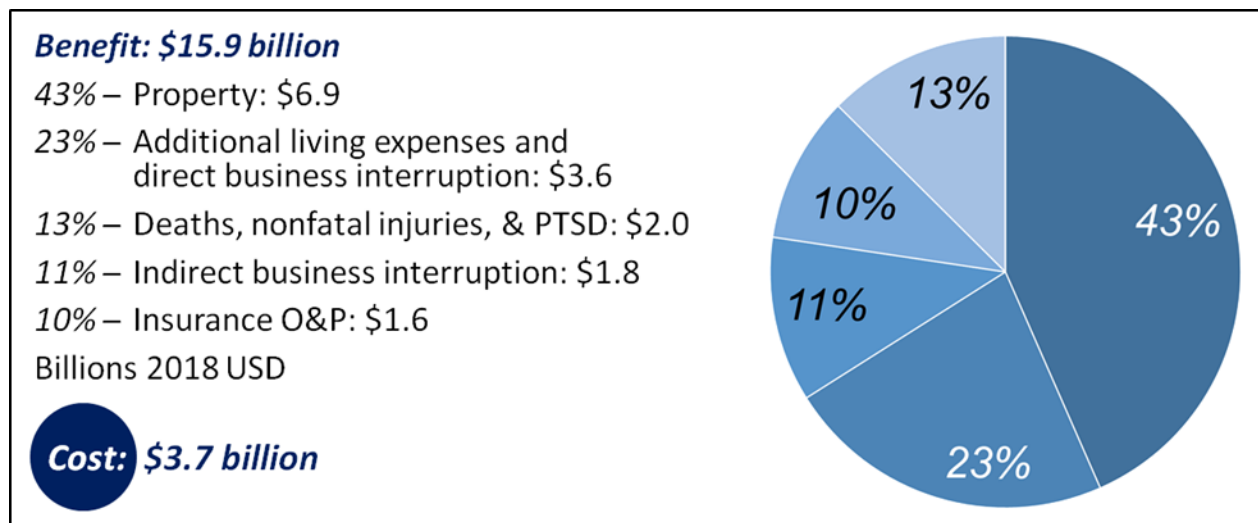

Figure 2-71: Total costs and benefits of new design to exceed 2015 I-Code requirements.

Considering the subtotal for the past 23 years of federally funded natural hazard mitigation, at the 2.2% cost-of-borrowing discount rate, the program team's analysis suggests that society will ultimately save \$6 for every \$1 spent on up-front mitigation cost, as shown in Table 2-17. Figure 2-72 shows the contributions to the calculation of these benefits.

## NATURAL HAZARD MITIGATION SAVES:

Table 2-17: Costs and benefits associated with 23 years of federal grants (in \$ billions).

Mitigation category	Cost (billions)	Benefit (billions)	BCR
Grants for riverine flood 1993-2016	\$ 11.50	\$ 82.00	7
Grants for wind 1993-2016	\$ 13.60	\$ 70.00	5
Grants for earthquake 1993-2016	\$ 2.20	\$ 5.70	3
Grants for fire at WUI 1993-2016	\$ 0.06	\$ 0.17	3
Total from federal grants 1993-2016	\$ 27.4	\$157.9	6

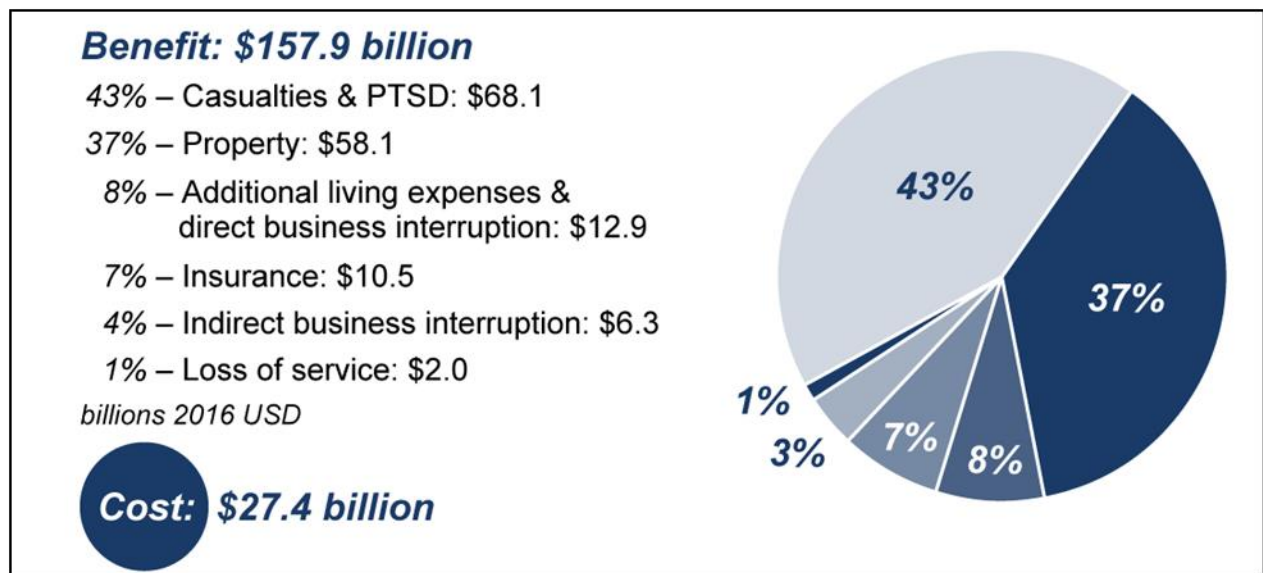

Figure 2-72: Total costs and benefits of 23 years of federal mitigation grants.

The costs and benefits of adopting 2018 I-Code requirements are shown in Table 2-18. It shows that current building codes cost an estimated \$1.2 billion per year in additional construction cost, but save 11 times that amount in avoided future losses. The baseline or starting point for each peril varies: flood benefits and costs are relative to NFIP elevation requirements, and consider only properties in special flood hazard protection areas (100-year floodplains). For wind, the baseline is pre-Hurricane Andrew construction along the Gulf and Atlantic coasts. For earthquake, the baseline is structural strength and stiffness 67% of their current values, like buildings built around 1990, for places in the contiguous 48 states where earthquake strength exceeds wind strength for a typical commercial building. Figure 2-73 shows the contributions to the calculation of these benefits.

## NATURAL HAZARD MITIGATION SAVES:

**Table 2-18:** Costs and benefits associated with constructing new buildings in 1 year to adopt 2018 I-Code requirements (in \$ billions).

Mitigation category, 1 year of new construction	Cost (billions)	Benefit (billions)	BCR
Adopt 2018 I-Code for riverine flood (from NFIP)	\$0.10	\$0.6	6
Adopt 2018 I-Code for hurricane wind (from 1990)	\$0.54	\$5.5	10
Adopt 2018 I-Code for earthquake (from 1990)	\$0.60	\$7.0	12
<b>Total, 1 year of design to adopt 2018 I-Code requirements</b>	<b>\$1.2</b>	<b>\$13</b>	<b>11</b>

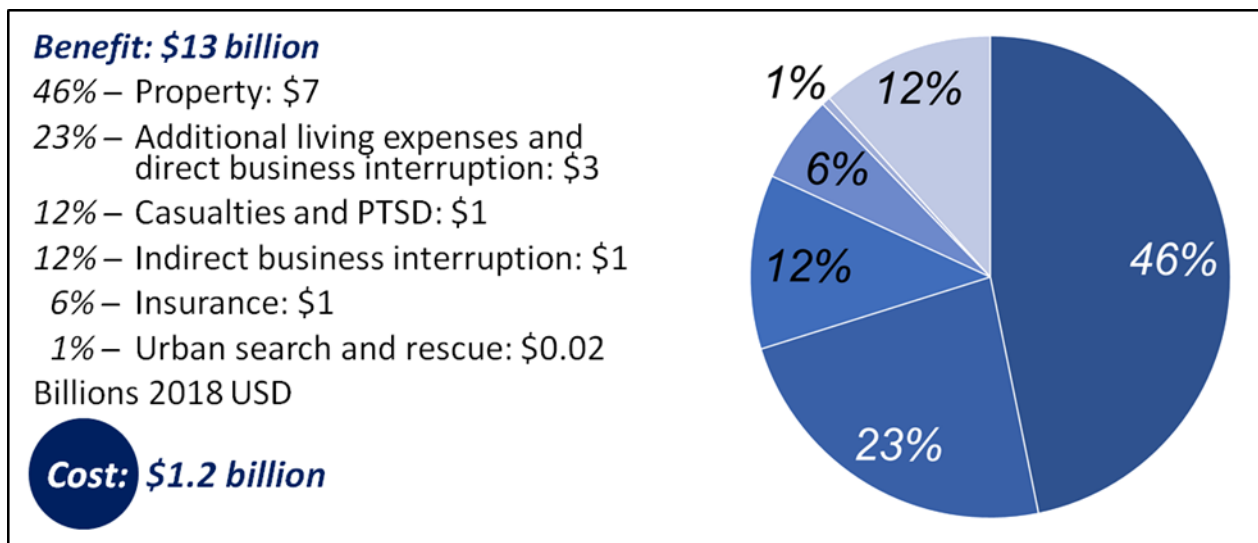

**Figure 2-73:** Total costs and benefits of adopting 2018 I-Codes.

## 2.8. RECAP OF INTERIM STUDY FINDINGS

To recap, first, all 12 categories of natural hazard mitigation studied to date appear to be cost effective, with BCRs varying between 3:1 and 12:1. They show once again that natural hazard mitigation saves, both in the private and public sectors, and for a variety of perils. Second, the subtotals for designing to exceed 2015 I-Code requirements in the future, 23 years of past grants show that both broad categories of natural hazard mitigation, and adopting 2018 I-Codes also all appear to be cost effective, with BCRs of 4:1, 6:1, and 11:1, respectively. Third, all major stakeholder groups enjoy net benefits from new design to exceed code requirements for flood, wind, and earthquake, and to comply with the 2015 IWUIC in the case of fire. These results show that society can cost effectively protect itself from natural hazard risk in multiple ways, both by mitigating past problems and by preventing future ones.

## 2.9. NATURAL HAZARD MITIGATION SAVES IN EVERY STATE

Considering the past 23 years of federal grants to mitigate flood, wind, earthquake, or fire at the WUI, every state in the contiguous United States is estimated to save at least \$10 million in avoided future losses. Most states will save at least \$1 billion, and four—Louisiana, New Jersey, New York, and Texas—will save at least \$10 billion in avoided future losses. See Figure 2-74.

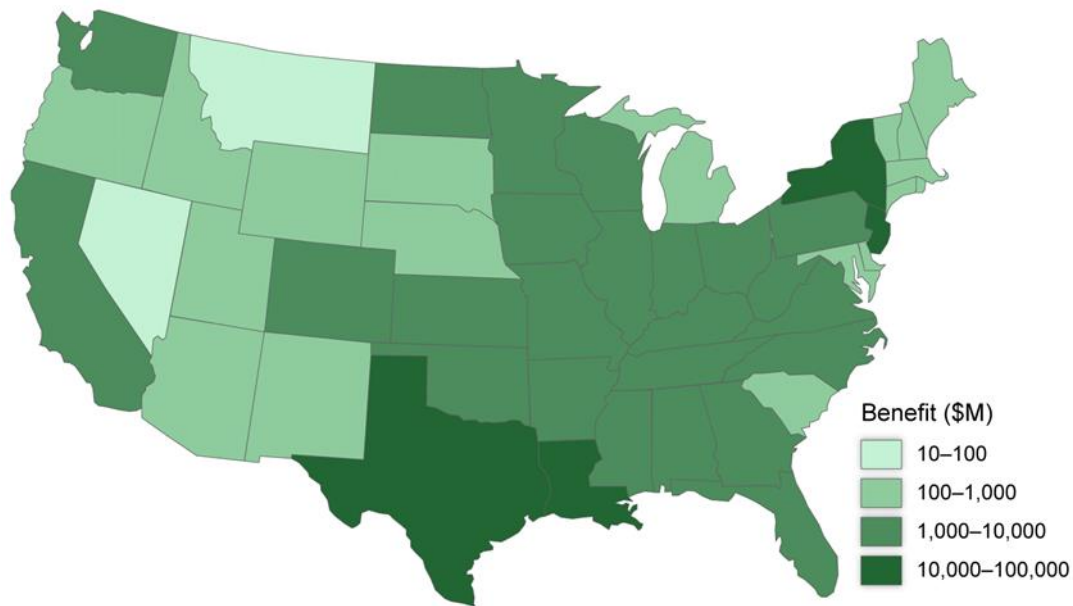

Figure 2-74: Aggregate benefit by state from federal grants for flood, wind, earthquake, and fire mitigation.

## 2.10. ALL STAKEHOLDERS BENEFIT FROM ADOPTING OR EXCEEDING I-CODE REQUIREMENTS

The project team set out to determine who wins and who loses when it came to designing to exceed 2015 I-Code requirements, and found that there are no losers, at least on average, in the long run, at the broad level of these stakeholder groups. The research produced similar findings for the last 30 years of code development: that every stakeholder group has benefited overall from improvements in code requirements for natural hazards.

Figure 2-75 shows that all four categories of designing to exceed 2015 I-Code requirements—for flood, wind, earthquake, and fire at the WUI—produce positive net benefits to developers, title holders, lenders, tenants, and the community. All of society wins when builders make new buildings meet an IEMax level of design to exceed 2015 I-Code requirements where it does not make financial sense, on a societal level, to do so. The benefits to tenants and owners only accrue to those who own or occupy buildings designed to exceed 2015 I-Code

## NATURAL HAZARD MITIGATION SAVES:

requirements, not, for example, to the people who live or work in older buildings or buildings that are not designed to exceed I-Code requirements. However, even those who do not own or occupy those buildings enjoy a share of the community benefits. (See Section 4.23 for an in-depth examination of stakeholder benefits.)

Figure 2-76 similarly shows that designing to comply with 2018 I-Code requirements—for flood, hurricane wind, and earthquake—produces positive net benefits to developers, title holders, lenders, tenants, and the community, relative to design requirements of a generation ago.

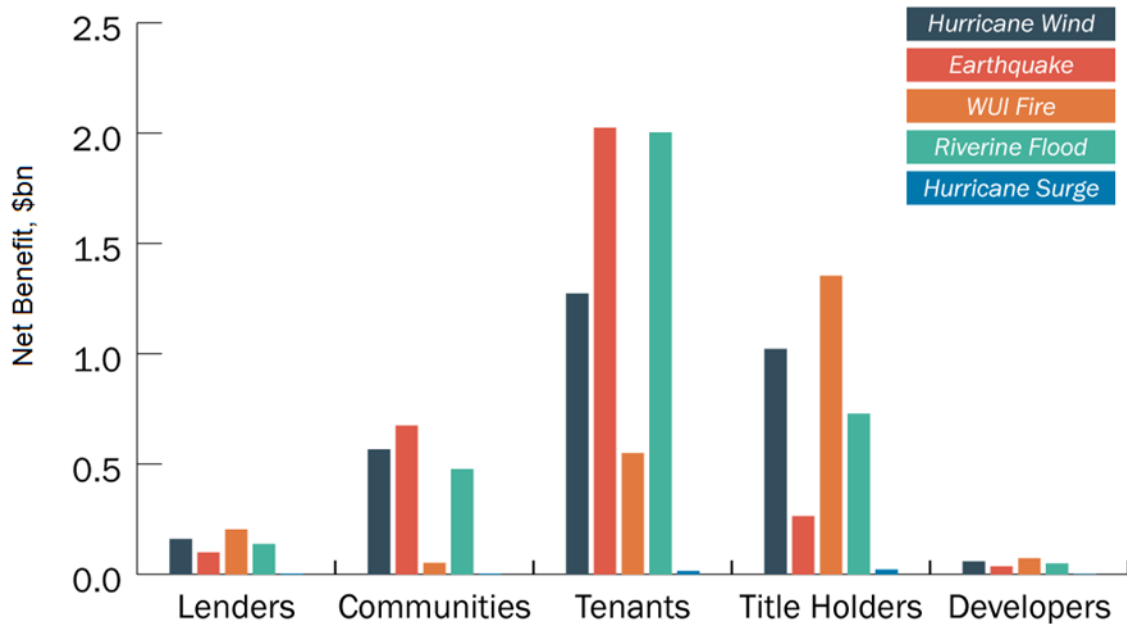

Figure 2-75: Stakeholder net benefits resulting from 1 year of constructing all new buildings to exceed select 2015 IBC and IRC requirements or to comply with 2015 IWUIC.

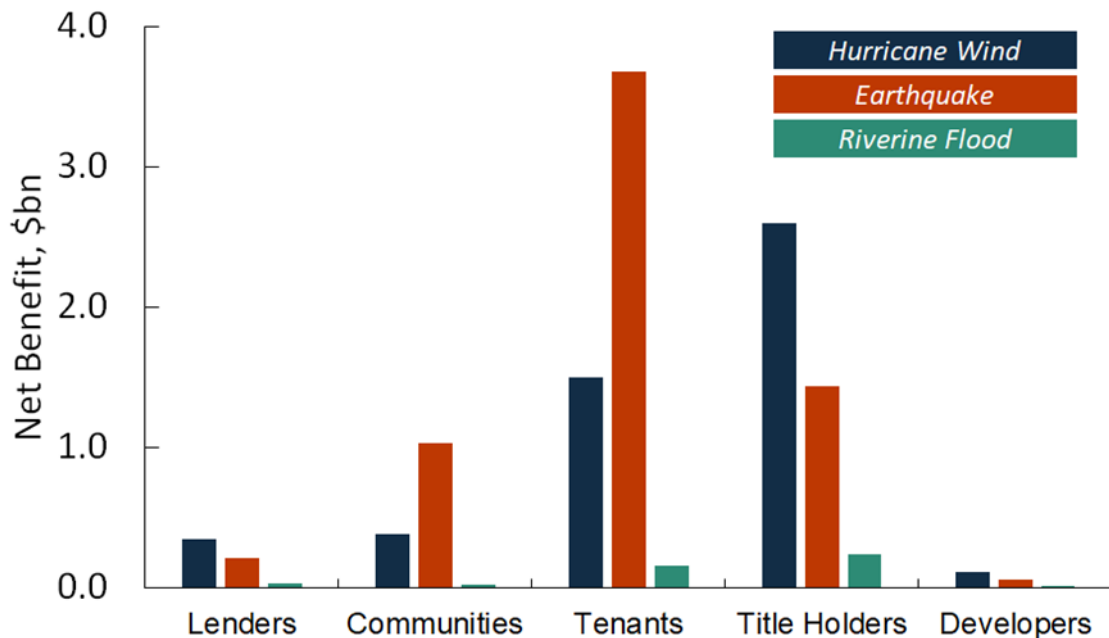

Figure 2-76: Stakeholder net benefits per year of new construction resulting from the last 30 years of code development.

## 2.11. SYNERGIES ACROSS MITIGATION STRATEGIES

Synergies exist where two or more dissimilar mitigation actions are undertaken at a single facility or single system of facilities. “Dissimilar mitigation actions” are those actions that attempt to mitigate risk in different ways, such as combining efforts to strengthen an existing building using above-code measures with emergency planning for the same facility. A system of facilities refers to facilities that interact in important ways (such as the different buildings on a medical campus). While the project team examined systems of facilities (such as two buildings on the University of California San Francisco medical campus for the federal grant earthquake mitigation sample), the project team did not examine cases where two or more dissimilar mitigation actions have been undertaken at them.

Moving forward, the project team might examine synergies, but they do not yet apply. Possible exceptions that have not been quantified:

- Designing to exceed 2015 I-Code earthquake requirements should reduce losses resulting from fire following an earthquake. Strengthening and stiffening a building to better resist earthquake damage will also tend to reduce damage to its fire-resistive features and thus reduce damage from fire following an earthquake. However, the present loss estimates for designing to exceed 2015 I-Code requirements do not include fire losses.
- Widely adopting the 2015 IWUIC for new buildings (as in the study of above-code measures) would tend to reduce losses to existing buildings (as under federal mitigation grants) in the same

neighborhood. The phenomenon resembles a preventive anti-epidemic measure to prevent occurrence and spread of infectious disease in a population.

- Designing to exceed 2015 I-Code earthquake requirements should reduce losses resulting from wind. Similarly, adopting an IBHS FORTIFIED Home Hurricane measure might reduce earthquake losses. Both measures improve the building's ability to resist lateral forces. The synergy benefit is likely to be small or negligible for the cases examined here because of details of the load path. The benefit would be more significant for manufactured homes, especially the addition of an engineered tie-down system (ETS) to an otherwise unrestrained manufactured home.

## 2.12. APPLYING ALTERNATIVE DISCOUNT RATES

### 2.12.1. OMB Discount Rates

OMB procedures call for BCAs to be performed considering a 3% discount rate and a 7% discount rate to reflect the time value of money. In cases where benefits all accrue from reduced future losses (as in the case of designing to exceed I-Code requirements and retrofitting existing buildings), using a 3% discount rate and a 75-year useful life of a new building reduces the present value of monetary benefits by about 19%, e.g., the present value of monetary benefits under a 3% discount rate is about 0.81 times the present value at the cost-of-borrowing discount rates documented in Appendix H of the Interim Study. Using a 7% discount rate for monetary benefits produces a present value of monetary benefits equal to about 0.39 times the present value of benefits at the cost-of-borrowing discount rate. The analysis does not discount deaths, nonfatal injuries, or PTSD for reasons discussed in the *2005 Mitigation Saves* study and elsewhere in the Interim Study. As a consequence, benefit totals that include both monetary and non-monetary benefits do not scale by 0.81 or 0.39, for 3% or 7% discount rates respectively.

In the case of code adoption, some benefits accrue from reduced future losses and other benefits accrue from reduced up-front construction costs. Some costs result from higher up-front construction costs and some from higher future losses. In this case, the effect of using a different discount rate does not have a predictable effect on BCR, because in some cases a higher discount rate reduces benefits (where code adoption reduces future losses), whereas in others a higher discount rate reduces the costs (where code adoption increases future losses, but those future losses are valued less because they take place in the future). Thus, a higher discount rate can decrease BCRs in some counties while increasing them in others, so the overall BCR under a higher discount rate can be the same, higher, or lower than under a lower discount rate. Table 2-19, Table 2-20, and Table 2-21 present the BCRs found at multiple discount rates.



**Table 2-19:** Total BCR of exceeding 2015 I-Codes at various discount rates.

Mitigation category	BCR at various discount rates		
	2.2%	3%	7%
Exceed 2015 I-Code requirements for riverine flood	5	4	3
Exceed 2015 I-Code requirements for hurricane surge	7	6	3
Exceed 2015 I-Code requirements for hurricane wind	5	4	2
Exceed 2015 I-Code requirements for earthquake	4	3	2
Comply with 2015 IWUIC	4	3	2
<b>Total, 1 year of exceeding 2015 I-Codes</b>	<b>4</b>	<b>4</b>	<b>2</b>

**Table 2-20:** Total BCR of federal mitigation grants at various discount rates.

Mitigation category	BCR at various discount rates		
	2.2%	3%	7%
Grants for riverine flood	7	6	3
Grants for wind	5	5	5
Grants for earthquake	3	2	1.3
Grants for fire at WUI	3	2	1.3
<b>Total, 23 years of grants</b>	<b>6</b>	<b>5</b>	<b>4</b>

**Table 2-21:** Total Incremental BCR of adopting 2018 I-Codes from the identified baselines at various discount rates.

Mitigation category	BCR at various discount rates		
	2.2%	3%	7%
Adopt 2018 I-Code requirements for riverine flood	6	5	2
Adopt 2018 I-Code requirements for hurricane wind	10	8	4
Adopt 2018 I-Code requirements for earthquake	12	10	6
<b>Total, 1 year of adopting 2018 I-Codes</b>	<b>11</b>	<b>9</b>	<b>5</b>

### 2.12.2. Calculating BCRs with a 3% Discount Rate

Using a 3% discount rate to reflect the time value of money produces the total costs and benefits shown in Table 2-22, Table 2-23, and Table 2-24, expressed in billions of dollars. The benefit in each category is smaller than using a cost-of-borrowing discount rate and the aggregated benefits are smaller (\$13.2 billion rather than \$15.9 billion and \$139.8 billion rather than \$157.9 billion respectively), but even at the higher discount rate, natural hazard mitigation still appears to be cost effective in every category.

## NATURAL HAZARD MITIGATION SAVES:

If all new buildings were built to the IEMax, above-code design for one-year, new construction would save approximately \$4 in avoided future losses for every \$1 spent on additional, up-front construction cost. Actually, the 3.6 BCR underestimates the true BCR, since it assumes the same degree of design to exceed 2015 I-Code requirements as estimated for the IEMax design at the cost-of-borrowing discount rate. With the higher discount rate, fewer locations would be designed to higher levels, and both costs and benefits would drop, rather than just costs. In any case, designing to exceed 2015 I-Code requirements remains cost effective in all five categories.

Considering the total for the past 23 years of federally funded natural hazard mitigation at a 3% discount rate, society ultimately saves approximately \$5 for every \$1 spent. See Table 2-23.

Considering the adoption of 2018 I-Codes relative to construction to various lesser standards, using a 3% discount rate suggests society would ultimately save \$8 for every \$1 spent, as detailed in Table 2-24.

**Table 2-22:** Total cost, benefit, and BCR of exceeding 2015 I-Codes, using a 3% discount rate.

Mitigation category	Cost (billions)	Benefit (billions)	BCR
Exceed 2015 I-Code requirements for riverine flood	\$ 0.91	\$ 3.67	4
Exceed 2015 I-Code requirements for hurricane surge	\$ 0.01	\$ 0.04	6
Exceed 2015 I-Code requirements for hurricane wind	\$ 0.81	\$ 3.40	4
Exceed 2015 I-Code requirements for earthquake	\$ 1.13	\$ 3.59	3
Comply with 2015 IWUIC	\$ 0.80	\$ 2.48	3
<b>Total, 1 year of exceeding 2015 I-Codes</b>	<b>\$ 3.77</b>	<b>\$ 13.213.18</b>	<b>4</b>

**Table 2-23:** Total cost, benefit, and BCR of federal mitigation grants, using a 3% discount rate.

Mitigation category	Cost (billions)	Benefit (billions)	BCR
Grants for riverine flood	\$ 11.50	\$ 66.37	6
Grants for wind	\$ 13.60	\$ 68.48	5
Grants for earthquake	\$ 2.20	\$ 4.83	2
Grants for fire at WUI	\$ 0.06	\$ 0.14	2
<b>Total, 23 years of grants</b>	<b>\$ 27.4</b>	<b>\$ 139.8</b>	<b>5</b>

**Table 2-24:** Total cost, benefit, and BCR of adopting 2018 I-Codes from various baselines and geographic areas, using a 3% discount rate.

Mitigation category	Cost (billions)	Benefit (billions)	BCR
Adopt 2018 I-Code requirements for riverine flood	\$ 0.1	\$ 0.5	5
Adopt 2018 I-Code requirements for hurricane wind	\$ 0.5	\$ 4	8
Adopt 2018 I-Code requirements for earthquake	\$ 5.2	\$ 43	8
Total, 1 year of exceeding 2015 I-Codes	\$ 5.8	\$ 48	8

### 2.12.3. Calculating BCRs with a 7% Discount Rate

Using a 7% discount rate to reflect the time value of money produces the total costs and benefits shown in Table 2-25, Table 2-26, and Table 2-27, expressed in billions of dollars. The benefit in each category is smaller than using a cost-of-borrowing discount rate because future benefits are more heavily discounted. The aggregate benefits are much smaller (\$7.3 billion rather than \$15.9 billion and \$101.9 billion rather than \$157.9 billion respectively), but even at the higher discount rate, natural hazard mitigation still appears to be cost effective in every category.

Consider the total for 1 year of designing to exceed 2015 I-Code requirements and to comply with the 2015 IWUIC. New construction would save approximately \$2 in avoided future losses for every \$1 spent on additional, up-front construction cost. Now consider the subtotal for the past 23 years of federally funded natural hazard mitigation. At a 7% discount rate, society saved approximately \$4 for every \$1 spent.

Considering the adoption of 2018 I-Codes relative to construction to various lesser standards, using a 7% discount rate suggests society would ultimately save \$5 for every \$1 spent, as detailed in Table 2-27.

**Table 2-25:** Total cost, benefit, and BCR of exceeding 2015 I-Codes using a 7% discount rate.

Mitigation category	Cost (billions)	Benefit (billions)	BCR
Exceed 2015 I-Code requirements for riverine flood	\$ 0.91	\$ 2.28	3
Exceed 2015 I-Code requirements for hurricane surge	\$ 0.01	\$ 0.03	3
Exceed 2015 I-Code requirements for hurricane wind	\$ 0.81	\$ 1.61	2
Exceed 2015 I-Code requirements for earthquake	\$ 1.20	\$ 2.16	2
Comply with 2015 IWUIC	\$ 0.80	\$ 1.26	2
Total, 1 year of exceeding 2015 I-Codes	\$ 3.77	\$ 7.33	2

**Table 2-26:** Total cost, benefit, and BCR of federal mitigation using a 7% discount rate.

Mitigation category	Cost (billions)	Benefit (billions)	BCR
Grants for riverine flood	\$ 11.50	\$ 33.81	3
Grants for wind	\$ 13.60	\$ 65.10	5
Grants for earthquake	\$ 2.20	\$ 2.88	1.3
Grants for fire at WUI	\$ 0.06	\$ 0.07	1.3
Total, 23 years of grants	\$ 27.4	\$ 101.9	4

**Table 2-27:** Total cost, benefit, and BCR of adopting 2018 I-Codes from various baselines and geographic areas using a 7% discount rate.

Mitigation category	Cost (billions)	Benefit (billions)	BCR
Adopt 2018 I-Code requirements for riverine flood	\$ 0.1	\$ 0.2	2
Adopt 2018 I-Code requirements for hurricane wind	\$ 0.5	\$ 2	4
Adopt 2018 I-Code requirements for earthquake	\$ 5.2	\$ 25	5
Total, 1 year of exceeding 2015 I-Codes	\$ 5.8	\$ 27	5

## **2.13. JOBS CREATED BY ADOPTING OR EXCEEDING COMMONLY ADOPTED I-CODE REQUIREMENTS**

If all new buildings were built to exceed commonly adopted I-Code requirements to the incrementally efficient maximum for 1 year, the extra materials and labor would add \$3.6 billion in construction expenses. The project team elsewhere estimated that new construction adds or replaces about 1% of existing construction each year. As of 2016, existing buildings totaled approximately \$36.2 trillion (Porter, unpublished), so all new construction amounts to about 1% of that quantity, or approximately \$362 billion in annual new construction. (Not purchase price, just the replacement cost of the buildings. Note also that the 1% figure is a rule of thumb; actual new construction varies from year to year.) Thus, adding \$3.6 billion in construction costs for 1 year of design to exceed commonly adopted I-Code requirements (Table 2-16) equates with a 1% increase in current annual construction costs. Here, exceeding commonly adopted I-Code requirements means building new buildings to comply with IBHS FORTIFIED Hurricane standards, making new buildings stronger and stiffer to resist earthquakes than required by the 2015 I-Codes, building new buildings more than 1 foot above base flood elevation to resist flooding damage, and adopting the 2015 IWUIC where it is cost effective to do so.

Similarly, the last few decades of code development have raised construction costs slightly, by approximately \$1.2 billion (about 0.3% of \$362 billion) for each year of new construction over what they would have been if buildings were designed next year as they were around 1990 (Table 2-18).

## NATURAL HAZARD MITIGATION SAVES:

Applying Equation 4-44 to all perils (flood, wind, earthquake, and WUI fire), the project team estimated that code development since 1990 has added 30,000 new jobs to the construction-material industry, and that new design to exceed 2015 I-Code requirements would add another 87,000 jobs.

The project team did not attempt to quantify job creation for federally funded natural hazard mitigation to existing buildings. See Section 4.23 for a discussion on how the project team calculated job creation.

### 2.14. AVOIDED DEATHS, INJURIES, AND CASES OF PTSD

The project team estimated that new buildings designed to exceed 2015 I-Code requirements and to comply with the 2015 IWUIC would avoid deaths, nonfatal injuries, and incidents of PTSD that by U.S. government standards would be worth spending \$2.0 billion. Considering the relative rates of deaths and injuries in applying above-code measures for earthquake, that \$2 billion equates with preventing approximately 32,000 nonfatal injuries, 20 deaths, and 100 cases of PTSD.

The past 23 years of federally funded natural hazard mitigation is estimated to prevent deaths, nonfatal injuries, and PTSD worth \$68 billion, equivalent to approximately 1 million nonfatal injuries, 600 deaths, and 4,000 cases of PTSD. (See Section 4.18 for more details on the calculation of injuries, deaths and PTSD.)

#### Box 2-3. Natural-Hazard Mitigation Saves Lives

The past 23 years of mitigation provide the majority of the estimated savings in deaths, nonfatal injuries, and PTSD, compared with 1 year of designing to exceed 2015 I-Code requirements, probably because (a) past grants have focused on mitigating the most-risky existing buildings, and (b) current I-Codes do a very good job of protecting life. However, both kinds of mitigation do save lives. Together, they will prevent an estimated 620 deaths, 1 million injuries, and 4,100 cases of PTSD. The BCRs presented here already reflect the enhanced life safety using U.S. government figures of the acceptable cost to avoid future statistical deaths and injuries, but it seems worthwhile to remember that the safety benefits across these mitigation strategies reflect the safety of more than 1 million people and their families who will be able to continue their lives after a natural disaster because foresighted individuals, communities, and governments took action and invested money to protect them before disaster struck.

**Evaluating Reasonableness of the Results.** The U.S. National Center for Health Statistics estimated that floods and storms killed approximately 475 people in the United States in the years 2006 through 2010 inclusive (Berko et al. 2014), or about 100 deaths per year. Because this period does not include 2005, in which Hurricane Katrina killed between 1,200 and 1,800 people, the longer-term average might be closer to 200 deaths per year. Compare these statistics with avoiding 20 deaths per year from designing to exceed 2015 I-Code requirements and about 30 avoided deaths per year from federal grants for natural hazard mitigation the fatality estimates seem reasonable on an order-of-magnitude basis.

It is harder to validate the estimated number of nonfatal injuries, since the estimates include the vast majority (perhaps 9 out of 10) that do not require treatment in a hospital, either because they are self-treated or treated by medical professionals outside of a hospital. Approximately 1,600 nonfatal injuries and instances of PTSD occur per disaster-related fatality. In the 1994 Northridge Earthquake, Seligson and Shoaf (2003) estimated that approximately 250 nonfatal injuries required medical attention in a hospital for each death, 500 nonfatal injuries were treated by medical personnel outside of a hospital for each fatality, and nearly 7,000 people self-treated injuries per fatality. The figure estimated here—1,600 injuries per death—lies within the range of injuries per death suggested by Seligson and Shoaf.

### 2.15. SAVINGS TO THE FEDERAL TREASURY

The *2005 Mitigation Saves* study estimated the savings to the federal treasury that resulted from FEMA-funded natural hazard mitigation. The estimate resulted from multiplying federal expenditures during the period 1993–2003 by the ratio of average annual property damage and casualty reduction to average annual property damage and casualty reduction in the United States during the same period. In the 2005 study, the project team estimated that ratio to be approximately 0.17. In the *Report*, the ratio is estimated to be 0.086, based on the quantities shown in Table 2-28. Using essentially the same methodology as the *2005 Mitigation Saves study*, the project team estimated that the natural hazard mitigation efforts ultimately save the federal treasury \$920 million annually, as detailed in Table 2-29. That \$920 million figure is smaller than the \$970 million figure estimated in 2005 (about \$1.4 billion in 2018 USD) because savings are estimated using a factor that has in its denominator the total annual costs of natural hazards. The total annual costs of natural hazards has risen greatly since 2005, despite the increase in annual federal mitigation expenditures: from \$7.1 billion in the years before 2005 to about \$9.2 billion in recent years (both in 2018 USD)—an increase of 30%. The estimate of the factor  $f$  is therefore lower than in 2005 by about half: \$5.0 billion annual reduction in the cost of natural disasters, divided by the average annual cost of natural disasters in three sample years, \$58.3 billion. Thus,  $f = 5.00 / 58.3 = 0.086$ .

**Table 2-28:** Factor  $f$  used to estimate savings to the Federal Treasury.

Quantity	Billions
Total benefit $B$	
Code compliance for 1 year, billions of 2018 USD	\$ 13.10
Above-code design for 1 year, billions of 2018 USD	\$ 16.16
Utilities and transportation lifelines, billions of 2018 USD	\$ 2.50
Federal mitigation grants, 23 years, billions of 2018 USD	\$152.61
Total benefit $B$ from natural hazard mitigation	\$184.37
Fraction of total benefit $B$ from natural hazard mitigation	
Code compliance for 1 year	7%
Above-code design for 1 year	9%

## NATURAL HAZARD MITIGATION SAVES:

Quantity	Billions
Utilities and transportation lifelines	1%
Federal mitigation grants, 23 years	83%
$\Delta$ EAL: annual reduction in catastrophe losses, i.e., annuity with present value $B$ with discount rate 2.2% (Appendix H) and effective life of 75 yr	
Code compliance for 1 year	\$ 0.36
Above code design for 1 year	\$ 0.44
Utilities and transportation lifelines	\$ 0.07
Federal mitigation grants	\$ 4.14
Total $\Delta$ EAL from natural hazard mitigation, billions of 2018 USD	\$ 5.00
Average annual cost of natural disasters, 3 sample years <sup>(a)</sup>	
2011	
2011 money, billions of 2011 USD	\$ 16.00
2011 deaths, billions of 2011 USD	\$ 5.00
2011 nonfatal injuries by approximate ratio with deaths <sup>(b)</sup>	\$ 49.97
2011 total, billions, inflated to billions of 2018 USD <sup>(c)</sup>	\$ 80.16
2014	
2014 money only, billions of 2014 USD	\$ 25.00
2014 add deaths and injuries by approximate ratio	\$ 7.50
2014 total, billions, inflated to 2018 USD <sup>(c)</sup>	\$ 34.74
2016	
2016 money <sup>(e)</sup> , billions of 2016 USD	\$ 46.00
2016 deaths <sup>(e)</sup> , billions of 2016 USD	\$ 1.31
2016 nonfatal injuries by approximate ratio	\$ 12.66
2016 total, inflated to 2018 USD	\$ 59.97
Average of 3 years, billions of 2018 USD	\$ 58.29
Factor $f$ : ratio of $\Delta$ EAL to average annual cost of natural disasters	0.086

(a) Based on numerous sources including National Oceanic and Atmospheric Administration (2017b)

(b) About \$10 nonfatal injuries per \$1 fatal injuries, as elsewhere in this study

(c) Inflated using gross domestic product implicit price deflator (Federal Reserve Bank of St. Louis)

(d) New York Times (<https://www.nytimes.com/interactive/2015/08/04/upshot/regional-natural-disasters.html>)

(e) Insurance Journal (<https://www.insurancejournal.com/news/national/2017/01/10/438452.htm>)

**Table 2-29:** Estimated annual savings to the Federal Treasury resulting from the four categories of natural hazard mitigation examined here.

Category of Federal Government Expenditures Saved	Quantity (base year \$ million)	Year	Quantity (2018 \$ million)	<i>f</i>	Savings (2018 \$ million)	Source of base data
Public assistance	\$5,229	2013	\$ 5,696	0.086	\$ 489	Federal Emergency Management Agency (2013d)
Individual assistance/human services	\$1,400	2015	\$ 1,481	0.086	\$ 127	Government Accountability Office (2014)
Mission assignments and standby grants	\$ 44	2016	\$ 46	0.086	\$ 4	Federal Emergency Management Agency (2016b, Table 5 Readiness support contracts and interagency agreements)
FEMA administrative costs	\$ 442	2016	\$ 462	0.086	\$ 40	Federal Emergency Management Agency (2017a)
Mitigation grants and contracts	\$ 387	2013	\$ 421	0.086	\$ 36	Federal Emergency Management Agency (2013d)
U.S. Small Business Administration default and administrative costs	\$1,032	2014	\$1,103	0.086	\$ 95	Small Business Administration (2012-16)
U.S. Army Corps of Engineers emergency measures	\$ 33	2016	\$ 35	0.086	\$ 3	U.S. Army Corps of Engineers (2016, Fig. 2)
Subtotal			\$9,243		\$ 795	
Federal tax revenues recouped					\$ 125	Multihazard Mitigation Council (2005, Table 6-8, ratio of subtotals)
<b>Grand total</b>					<b>\$ 920</b>	
Contribution to total						
Code compliance					\$ 67	7% of grand total
Above-code design					\$ 80	9% of grand total
Utils & trans. lifelines					\$ 13	1% of grand total



Category of Federal Government Expenditures Saved	Quantity (base year \$ million)	Year	Quantity (2018 \$ million)	<i>f</i>	Savings (2018 \$ million)	Source of base data
Federal grants					\$ 760	83% of grand total

## 2.16. OTHER SENSITIVITY TESTS

### 2.16.1. Designing to Exceed 2015 I-Code Requirements for Coastal Flooding

The 2017 project team examined how several uncertain input variables affect the estimated BCR for designing to exceed 2015 I-Code requirements for coastal flooding in coastal V- and VE-zones. These inputs included: 1) SLR; 2) discount rates; 3) storm surge height; and 4) economic life of the building.

The team tested five sea-level-rise scenarios, selected from among those examined by National Oceanic and Atmospheric Administration (2017), in addition to one other scenario. Each scenario depicts a path in which global mean sea level (GMSL) will rise by the end of the 21st century—ranging between zero and 2.5 meters (about 8 feet). See Table 2-30. Scenario 3 represents a baseline assumption.

**Table 2-30:** Sensitivity of the BCR for greater elevation of new coastal buildings to sea level rise (Low, Intermediate-low, intermediate-high, and extreme).

Scenario	1	2	3 (baseline)	4	5
National Oceanic and Atmospheric Administration (2017) label	(N/A)	Low	Int-low	Int-high	Extreme
GMSL rise by 2100 (m)	0.0	0.3	0.5	1.5	2.5
BCR (BCR)	6.4	7.0	7.3	8.4	9.1

The table shows that while SLR influences the BCR for building coastal buildings higher above BFE, the measure can be highly cost effective regardless of the degree of SLR.

Additional sensitivity tests. The project team also varied the discount rates, the economic life of the building, and the wave height, examining how each uncertain input affects the BCR. The team considered four discount rates: (1) baseline (cost-of-borrowing, approximately 2.2%), (2) OMB required value of 3%, (3) OMB required value 7%, and (4) no discounting. The project team tested sensitivity of BCR to the economic life of a new building: the baseline 75 years, plus two additional scenarios that adjust the economic life of the building by ± 15 years. Finally, wave height is uncertain. NOAA’s MOM wave heights used for this analysis are discussed at length in Section 4.11.2. Although these are scaled using FEMA FIS, they represent not only an independent view, but a source of uncertainty. The project team adjusted the wave heights by ± 25% at all locations, for all storm categories. Table 2-31 presents the results.

**Table 2-31:** Sensitivity of the BCR for greater elevation of new coastal buildings to other input variables.

	Baseline	Discount rate			Economic life		Wave height	
		0%	3%	7%	60 years	90 years	-25%	+25%
BCR	7.3	13.9	6.0	3.4	6.5	7.8	5.3	9.1

The table shows that regardless of uncertainty in these input variables, it is cost effective to design new coastal buildings higher above BFE than the 2015 I-Codes require. The BCR is most sensitive to wave height and discount rate, both with a range of approximately 3.8 (ignoring the 0% option discount rate). A reasonable domain of economic life produces a range of about 1.3.

### 2.16.2. Designing to Exceed 2015 I-Code Requirements for Hurricane Wind

The project team tested how strongly various uncertain inputs affect the BCR of compliance with the IBHS FORTIFIED Home and Commercial Hurricane Program. The project team varied three key parameters, each time keeping the others at their baseline value: 1) discount rate; 2) economic life of the building; and 3) design wind speeds. The analysis was conducted for discount rates of 0%, 3% and 7% (as opposed to approximately 2.2%, which was used as the baseline), for a 50-year and 100-year building life (as opposed to 75 years) and design wind speeds of  $\pm 5$  mph of those listed in ASCE 7-16 (American Society of Civil Engineers Structural Engineering Institute 2017). Table 2-32 shows how the BCR for the IEMax uptake of IBHS FORTIFIED Home and Commercial Hurricane varies with three important inputs. Figure 2-77 illustrates the table.

**Table 2-32:** Sensitivity of BCR for adopting IBHS FORTIFIED Home and Commercial Hurricane to three important inputs.

	Baseline	Discount rate			Economic life		Wind speed	
		0%	3%	7%	50 years	100 years	-5 mph	+5 mph
BCR	5.3	10.6	4.0	2.2	4.4	5.8	3.5	8.0

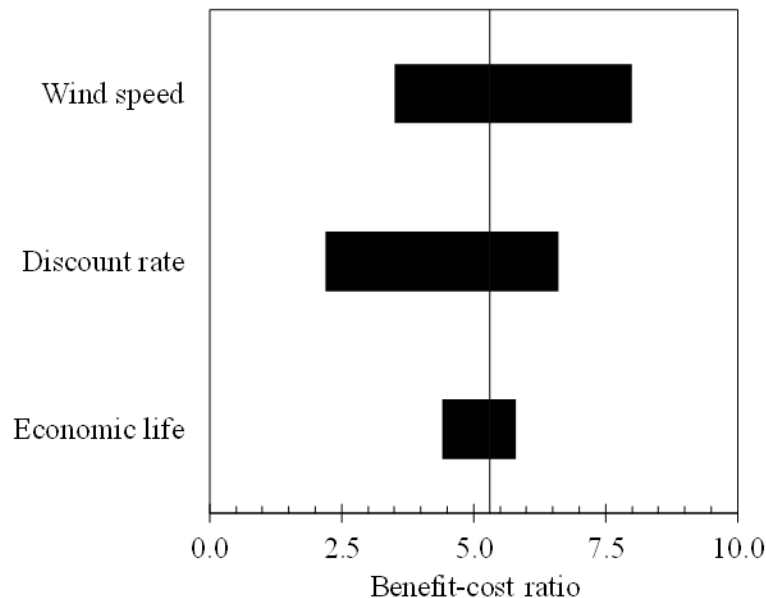

**Figure 2-77:** Sensitivity of BCR for designing to exceed 2015 I-Code requirements for wind to major uncertain variables.

Table 2-32 and Figure 2-77 both show that regardless of uncertainty in important inputs, designing to exceed 2015 I-Code requirements for hurricane wind using IBHS FORTIFIED Home and Commercial Hurricane can be cost effective, even with a very high discount rate of 7%. The fact that the BCR shows little sensitivity to uncertainty in the economic life of a new home (varying about  $\pm 15\%$  for a  $\pm 33\%$  change in economic life) reflects the fact that the last 25 years of economic life are the most discounted—they matter much less than the first 25 years. As for wind speed, the table shows that BCR is sensitive (varying by a factor of 1.5 either way) to where a building lies within a 10-mph wind speed band. A 10-mph band of basic wind speed (the wind speed with 700-year MRI) is about the width of a typical coastal county, which implies that two identical buildings, one on the Gulf or Atlantic Coast and the other at the far inland end of the county, will experience substantially different benefits from designing to exceed 2015 I-Code requirements.

### 2.16.3. Designing to Exceed 2015 I-Code Requirements for Earthquake

Benefits and costs of designing to exceed 2015 I-Code requirements for earthquake depend on more than how much the designer increases strength and stiffness. They also depend on the added cost of construction, building economic design life, building replacement cost, and several intermediate parameters of the vulnerability functions, which one might approximate with an overall multiplier on vulnerability. The project team tested the sensitivity of the BCR to these uncertain parameters using the values shown in Table 2-33. In most cases the project team chose high and low values by judgment. The table shows the baseline benefit, cost, and BCR on the first row, then the benefit, cost, and BCR for each what-if condition. The table includes the effects of varying discount rate, for completeness.

**Table 2-33:** Sensitivity of BCR for designing to exceed 2015 I-Code earthquake requirements to various uncertain parameters.

Parameter	Value	Benefit (\$ billion)	Cost (\$ billion)	BCR
Baseline				
		4.37	1.23	3.6
Discount rate				
Baseline	Varies			
OMB low	3%	3.59	1.13	3.2
OMB high	7%	1.83	0.79	2.3
Economic life (years)				
Baseline	75			
Short	50	3.50	1.24	2.8
Long	100	3.38	1.10	3.1
Replacement cost (multiple of baseline value)				
Baseline	1.00			
Low	0.67	3.84	1.19	3.2
High	1.50	5.25	1.32	4.0
Vulnerability (multiple of baseline value)				
Baseline	1.00			
Low	0.67	2.74	0.99	2.8
High	1.50	7.30	1.86	3.9
Construction cost to exceed 2015 I-Code earthquake requirements (x baseline)				
Baseline	1.00			
Low	0.67	4.86	1.23	3.9
High	1.50	4.09	1.48	2.8

The table shows that designing to exceed 2015 I-Code earthquake requirements is always cost effective for some fraction of the buildings built in 1 year (see the column labeled “cost”). It is always  $\pm 25\%$  of the baseline, meaning that in every scenario, designing to exceed 2015 I-Code requirements for earthquake would make sense on a BCR basis for 20 to 30% of the building stock. In each case, the overall nationwide average BCR varies within  $-50\%$  to  $+10\%$  of the baseline value. This illustrated in Figure 2-78, which sorts the uncertain input parameters (each corresponding to one of the horizontal bars) in decreasing order from top to bottom of the range of BCRs. The x-values of the ends of the bars correspond to the minimum and maximum BCRs resulting from varying that input. In some cases, one end of the bar

## NATURAL HAZARD MITIGATION SAVES:

corresponds to the baseline input, e.g., discount rate, where the baseline is less than either of the two values used by OMB.

All the values seem reasonable relative to the baseline. Higher discount rates should generally reduce cost effectiveness, because benefits accrue for reduction in future losses, and the less one values future dollars, the less the benefit. A longer economic life should increase cost effectiveness, since benefits accrue for a longer period of time. More value exposed to loss should generally increase the BCR. Similarly, greater vulnerability should generally increase the BCR, because more strength and stiffness will make a bigger difference in future losses. In addition, higher construction cost for designing to exceed 2015 I-Code requirements should generally decrease cost effectiveness.

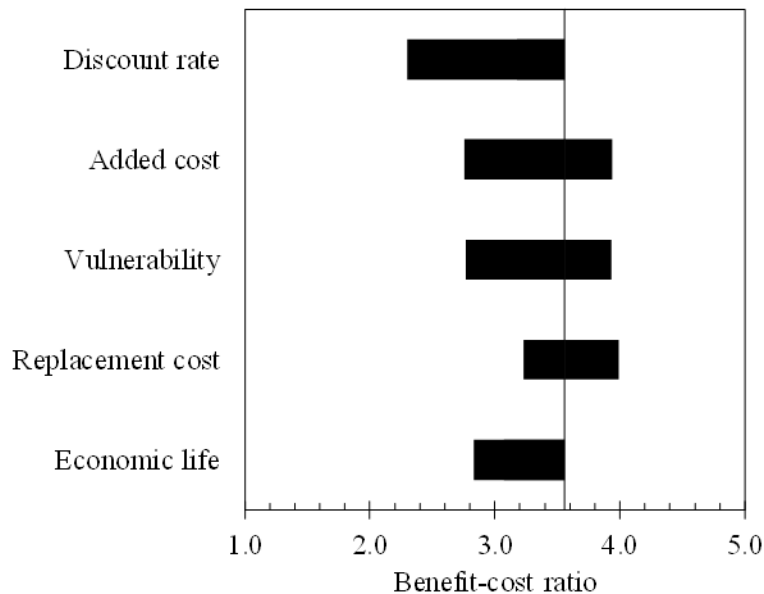

Figure 2-78: Diagram of sensitivity analysis of BCR for designing to exceed 2015 I-Code requirements for earthquake.

### 2.16.4. Designing to Comply with 2015 IWUIC

Figure 2-79 shows the sensitivity of the results for complying with the IWUIC to various inputs, where key inputs were varied  $\pm 33\%$ . Results are most affected by increases in BP or flame intensity level (e.g., the hazard) and the cost (e.g., value) of the house, all of which directly increase mitigation benefits. Increasing the cost of structural compliance is the next most-significant variable driving up overall cost and decreasing the BCR, as does an increase in interest rates (which drives up the cost of future vegetation management). The cost of mortality has a negligible effect: between 1990 and 2012, firefighter and civilian fatalities associated with wildland fire averaged between 10 to 20 and 5 to 10 per annum, respectively, according to the International Association of Wildland Fire (IAWF) (IAWF 2013). Very few of these occurred in structures, so the reduction of fatalities that would result from complying with the 2015 IWUIC, while accounted for, translated into a negligibly small dollar amount. The cost of PTSD is more significant. While

## NATURAL HAZARD MITIGATION SAVES:

negligibly few are killed, everyone suffers stress if their home is under threat, or destroyed, by fire. The cost of PTSD is significant, although still not widely recognized.

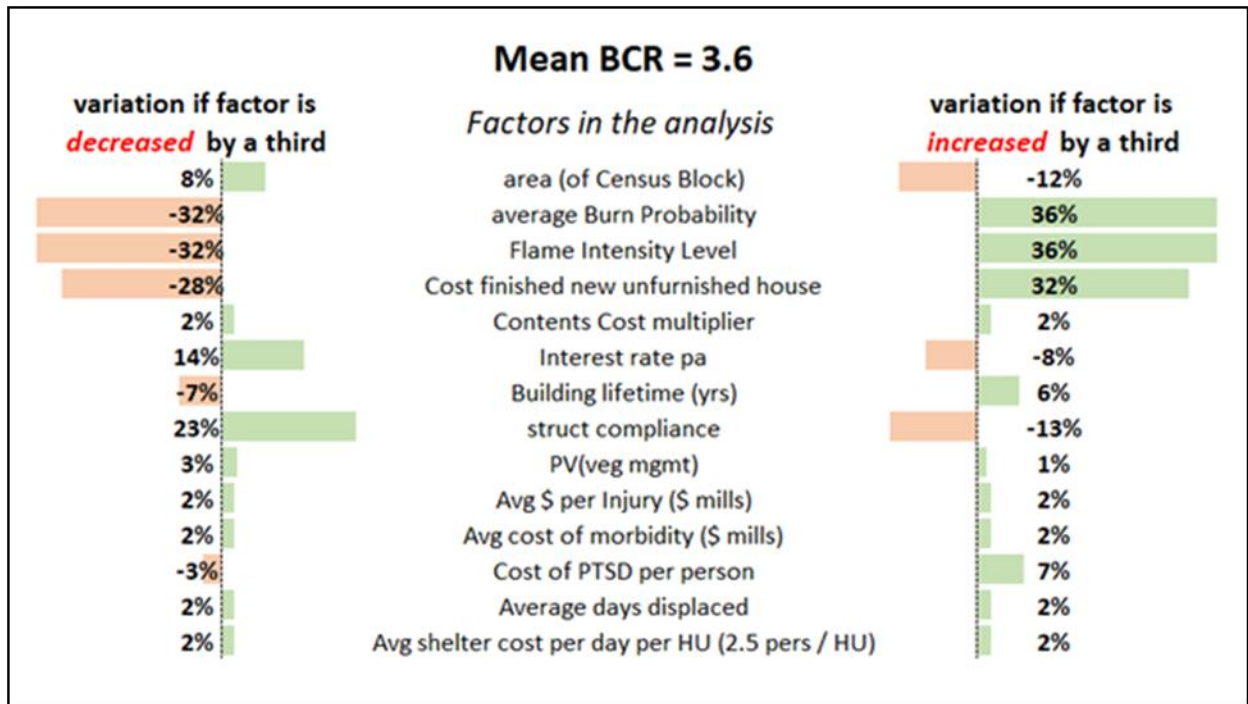

Figure 2-79: Sensitivity tests for compliance with 2015 IWUIC.

### 2.16.5. Federal Grants

In light of the findings that (1) designing to exceed 2015 I-Code requirements is cost effective regardless of reasonable values of the input variables, (2) the *2005 Mitigation Saves* study found similar results for federally funded natural hazard mitigation, and (3) BCRs for federal mitigation grants work are similar to, and somewhat higher than, those calculated in the *2005 Mitigation Saves study*, it seemed unnecessary for the project team to perform additional sensitivity analyses of federal mitigation grants work for the ongoing study.

## 3. Review of Mitigation Guidance and Quantification of Benefits

### 3.1. BUILDING ON PRIOR WORK

While the *2005 Mitigation Saves* study is a widely recognized study of mitigation measures and their BCRs, it is not the only such work. In preparation of the expanded Interim Study, the project team identified and reviewed relevant literature on building codes and standards (including guidance on going above such codes), methods to quantify disaster-related losses, and prior efforts to determine BCRs.

### 3.2. RELEVANT BUILDING CODES AND STANDARDS

Most communities in the United States require new buildings to comply with requirements of the IBC (e.g., International Code Council 2015a) or IRC (e.g., International Code Council 2015b) (Federal Emergency Management Agency 2019a). The IRC attempts through prescriptive methods to achieve approximately the same level of performance as the IBC does through engineering calculations (see International Code Council 2015b pg. vii). Code adoption—which particular version of the I-Codes or other model building codes each community uses—varies between states, and in some states, between cities.

To specify minimum design loads for wind, earthquake, and flood, the IBC adopts ASCE/SEI 7 by reference (American Society of Civil Engineers Structural Engineering Institute 2017). This standard also specifies the most widely accepted standard procedures in the United States for characterizing site conditions such as soil (for earthquake loading) and surface roughness (for wind loading) and for estimating one aspect of hazard as a function of another, such as ground motion on one soil type given ground motion on another.

ASCE/SEI 7 does not address fire at all, except for seismic requirements for fire sprinklers and fire protection of seismic isolation. The IBC addresses fire protection, though not fire at the WUI. Instead, the ICC offers the IWUIC (International Code Council 2015c). The IWUIC establishes “minimum standards to locate, design and construct buildings and structures or portions thereof for the protection of life and property, to resist damage from wildfires, and to mitigate building and structure fires from spreading to wildland fuels.” The IWUIC addresses access (especially for firefighting), water supply, ignition-resistant construction and materials, and defensible space (meaning the continuous maintenance of a largely flammable-free zone within 30 to 100 feet of a building for the life of the building).

### 3.3. HOW PAST DESIGN AND CONSTRUCTION DIFFERS FROM CURRENT I-CODES

#### 3.3.1. How Past Wind Design and Construction Differs from Current I-Codes

The wind loads prescribed for a particular structure are dependent on both the geographic location of the building and the wind hazard maps published at the time of design. Both the wind hazard and design requirements have changed from pre-Hurricane Andrew (circa 1990 construction) to 2018 I-Codes. Since hurricane damage is typically observed at the roof, a comparison of the required roof design pressures was necessary for the analysis.

The design wind roof pressures for ASCE 7-88 and ASCE 7-16 were compared by calculating the loads on the components and cladding (C&C) of the structure. In ASCE 7-88, a single basic wind speed map is provided. These values relate to a fastest-mile speed (or peak wind speed) with an annual probability of 0.02, also known as the 50-year mean recurrence interval(MRI). The map changed (both wind contours and design wind speeds) in ASCE 7-95, i.e., the values provided in ASCE 7-95 changed to nominal design 3-second gusts (mph), and mapped values varied from a 50- to 100-year MRI. With the release of ASCE 7-10, the design approach moved from an allowable stress design (ASD) approach to a strength/load resistance factor (LRFD) approach. This led to the revision of contours and design values for the basic wind speed maps. In addition, these maps incorporated considerable empirical data from Hurricane Katrina and other events. ASCE 7-16 (given an Occupancy Category II) currently provides nominal design 3-second gusts values, and assumes a 7% probability of exceedance in 50 years, an MRI of 700. In this study, the scope is limited to all hurricane prone regions as identified in ASCE 7-16, e.g., where basic wind speeds are greater than 115 mph.

To compare the design pressures across both codes (ASCE 7-88 and ASCE 7-16), the project team first had to calculate a wind speed that was consistent across both codes. In this case, a middle ground of the ASD wind speeds of ASCE 7-02 was chosen as the baseline. ASCE 7-88 values were converted from fastest mile to 3-second gusts (or equivalent ASCE 7-02 wind speed), using Table 1609.3.1 of the 2000 IBC, and ASCE 7-16 speeds were converted to ASCE 7-02 values using the equation  $V_{700}$  (or ASCE 7-16)  $\times \sqrt{0.6}$  (Equation 16-33 of 2012 IBC). Since the mapped wind contours do not align, the mapped ASCE 7-16 wind contour was chosen as the baseline boundaries. The project team then calculated the basic wind speed weighted area averages for ASCE 7-88. As an illustration, suppose within the ASCE 7-16 wind speed map that considers a 140 mph wind contour, only the 130 and 140 mph ASCE 7-02 wind contours intersect. The 130 mph contour accounts for 60% of the region within and the 140 mph contour accounts for the other 40%. The equivalent ASCE 7-02 wind speed for the ASCE 7-16, 140 mph wind contour would be equal to  $0.6 \times 130 \text{ mph} + 0.4 \times 140 \text{ mph}$ , or 134 mph. This procedure is repeated for all hurricane wind contours and both ASCE 7-88 and ASCE 7-02. A comparison of the equivalent ASD wind speeds can be viewed in Table 3-1.



Table 3-1: Comparison of allowable stress design wind loads (3-second gusts).

ASCE 7-16	Equivalent ASD wind speeds (mph)	
$V_{ult}$ (mph)	ASCE 7-16	ASCE 7-88
115	89.1	80.3
120	93.0	91.8
130	100.7	97.8
140	108.4	102.1
150	116.2	106.7
160	123.9	109.4
170	131.7	110.0
180	139.4	110.0

After the equivalent wind speeds between code editions were established, the C&C design pressures were calculated using the procedures set forth for 1990 construction (1990 BOCA and 1991 SBC) and ASCE 7-16. Design pressures are a function of building configuration, height, roof slope, exposure, amongst other building specific attributes. In the 1990 version of the NBC, a single design pressure (psf) is applied to the entire roof structure. With these loads, a design professional can specify the appropriate construction materials and hardware to resist the required shear and uplift demand. Later versions of the code established the additional loading observed at the roof edges, corners and ridges and required different net design wind pressures ( $p_{net30}$ ), and therefore specified unique zones. These zones are observed in ASCE 7-02, and were revised in ASCE 7-16 (see Figure 3-1). Once the design pressures were calculated for each zone (where required), the project team calculated an area weighted average, so a single design pressure could be compared across all three codes.

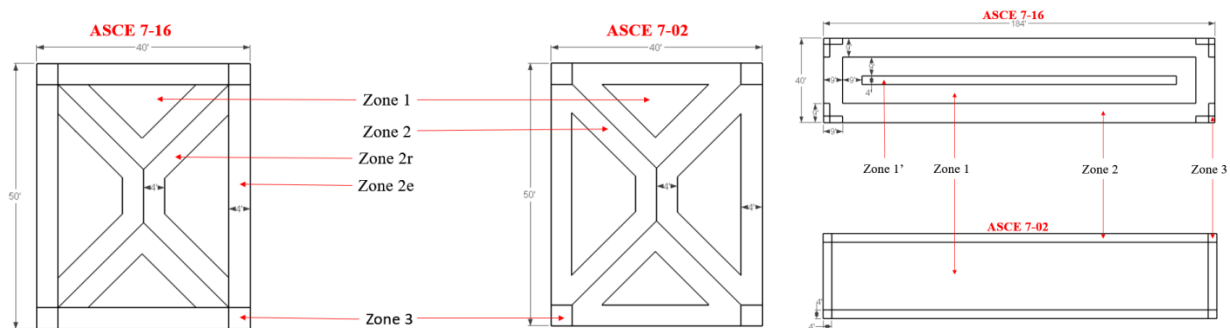

Figure 3-1: Evolution of ridge, end, and corner zones for roof design pressures.

For a flat, built-up roof common for commercial structures, a comparison of ASCE 7-88 and ASCE 7-16 requires an approximately 198% increase in design wind pressures. For single-family residential structures, a comparison of ASCE 7-88 and ASCE 7-16 requires an approximately 173% increase in design wind pressures. Table 3-2 and

## NATURAL HAZARD MITIGATION SAVES:

Table 3-3 compare the equivalent ASD design pressures for each version of the I-Code. This increased loading directly relates to increased roof design strengths, which is achieved by such measures as better and tighter roof sheathing nailing, hurricane straps for roof wood framed trusses, better roof cover and adhesives, better attachment to open web steel joists by way of stronger welds or mechanical fasteners.

**Table 3-2:** Comparison of commercial roof design pressures.

ASCE 7-16	Equivalent ASD design pressures (psf)	
V <sub>ult</sub> (mph)	ASCE 7-16	ASCE 7-88
115	32.2	15.5
120	35.1	20.1
130	41.1	22.9
140	47.7	24.9
150	55.1	27.0
160	62.4	28.3
170	70.4	28.6
180	78.9	28.6
Average increase	134%	198%

**Table 3-3:** Comparison of residential roof design pressures.

ASCE 7-16	Equivalent ASD design pressures (psf)	
V <sub>ult</sub> (mph)	ASCE 7-16	ASCE 7-88
115	28.1	16.7
120	30.6	21.6
130	35.9	24.6
140	41.7	26.7
150	47.8	29.0
160	54.4	30.3
170	61.4	30.6
180	68.8	30.6
Average increase	107%	173%

### 3.3.2. How Past and Some Current Flood Design and Construction Differs from Current I-Codes

Approximately 38% of communities that belong to the NFIP across the United States do not incorporate freeboard into their floodplain ordinance. This means that buildings constructed within these communities and located in the SFHA areas designated as Zone A are only required to be constructed to the BFE or the 1 percent annual chance of flooding. In Zone A, the top of the lowest floor must be at or above the BFE. Since 2015, the I-Codes have required at least one foot of freeboard be incorporated into the elevation requirements. Additional other requirements are included in the minimum requirements for protection of mechanical, electrical, and plumbing systems, incorporation of flood damage resistant materials, uses for enclosed areas below the BFE, and flood opening when there are enclosures. When freeboard requirements are added, the NFIP minimum requirements below the BFE are required to be adjusted to reflect the new minimum elevation requirement of BFE + 1 foot or whatever the minimum freeboard requirement states.

Beyond freeboard, ASCE 24-14 and, by reference, the I-Codes specify various detailing requirements that are not mandated by NFIP. The 2018 IRC requires that concrete slabs, stairways, ramps, decks, and porches in coastal high-hazard areas and coastal A-zones to be self-supporting or to break away from and not harm the structure.

Adoption of the I-Codes provides a valuable pre-construction review process for communities that wish to incorporate freeboard. While it is possible for communities to adopt freeboard through floodplain management ordinances alone, adoption of the I-Codes incorporates multiple checks and codifies the NFIP requirements so that building inspectors are verifying compliance throughout construction. This also provides designers and contractors with specifics on how to meet the NFIP requirements. Through the inspection process, code officials can also make sure that the minimum elevation requirement is being met prior to the survey necessary for the Elevation Certificate. While not evaluated in this study, the inspection process reduces additional cost of rework by contractors, avoidable costs to homeowners for noncompliance, and through improved compliance, reduces damage in communities.

While NFIP requirements state that all materials below the BFE must be flood damage-resistant materials, some level of damage is experienced when floodwaters reach these areas below BFE. The lack of freeboard increases the chance that areas below the BFE will be exposed to floodwater and thus need to be cleaned or repairs made. With one foot of freeboard, even during a base flood event, most floor framing for houses on crawlspaces would not be touched by floodwaters and minimize disruption for homeowners.

The adoption of the I-Codes also standardizes the inclusion of freeboard into the construction process. Although this increases the initial cost of construction, most home buyers finance the cost of the home. Since financing only requires home buyers to initially invest a portion of the entire cost through a down payment, the additional cost of freeboard is minimized. The remaining cost of freeboard is divided

monthly into mortgage payments. Homes within the SFHA are required to maintain flood insurance for federally backed mortgages, and lending institutions also require maintaining flood insurance even if they do not intend to sell the mortgage. Premium reductions are available to homes that have freeboard incorporated into the lowest floor elevation. These premium reductions are available to the homeowner immediately and can result in a return on investment (ROI) for the homeowner in potentially as little as 1 year, but often within only a few years. Future premium reductions will result in savings for the homeowner as long as they maintain flood insurance. Since home buyers are often unaware of the lowest floor elevation during the home selection process, the incorporation of freeboard throughout a jurisdiction reduces the effort necessary for the homeowner to determine the elevation prior to purchase.

Freeboard additionally provides a factor of safety both for current flood potential for events where due to uncertainty the flood level for a flood more frequent than the 1 percent annual chance event could exceed the BFE and to address future conditions where flood elevations can change due to future development either constricting flow or increased runoff. The one foot of freeboard additionally can provide protection over the life of the building for future climatic changes that could make higher flood levels more frequent. Incorporation of freeboard into the minimum design elevation also decreases the potential for floodborne debris to impact the superstructure of the building. Floodborne debris is often evaluated at or below the flood level. The freeboard means that debris during a base flood event would strike the foundation walls rather than the floor framing system. Floodborne debris was not possible to model during this study due to the complexity in the probability of floodborne debris and that most damage functions do not address debris strikes.

### 3.3.3. How Past Earthquake Design and Construction Differs from Current I-Codes

Seismic design requirements have evolved in many ways since their introduction in the 1927 edition of the Uniform Building Code. Appendix M recaps the major developments since 1927 in the Uniform Building Code and IBC and presents a quantitative analysis of changes in design strength and stiffness. Notable developments in the recent past (since 1990) include:

1. Long-term gradual increases in required strength and stiffness.
2. Improvements in nonstructural component design, such as the addition of compression struts and splay wires to suspended ceilings.
3. Additional detailing requirements, such as anchoring electrical equipment, that are triggered based on a combination of design-level shaking and the use to which the building is put, such as whether the building is a hazardous or essential facility.
4. Redundancy provisions.
5. Vertical and horizontal irregularity requirements.
6. Material design specification changes, such as changes to welded steel connections in moment frames after the 1994 Northridge Earthquake.
7. Overstrength factor and special seismic load combinations.

8. Increased diaphragm and anchorage requirements.
9. Building separation requirements.
10. Soil report requirements.
11. Enhanced observation and testing requirements.

Of these developments, the present study quantified the BCR of the long-term increases in strength and stiffness. If the various other detailing requirements were accounted for, the benefits would probably be greater and BCR would likely be higher, making the BCRs presented here somewhat conservative.

### 3.4. OPTIONS TO EXCEED COMMONLY ADOPTED CODE REQUIREMENTS

#### 3.4.1. Options to Exceed Minimum Wind Design Requirements

The project team identified multiple options to make a new building more resistant to wind loads than current codes require

**Building a Safe Room.** According to the introductory webpage for *FEMA P-320 - Taking Shelter from the Storm: Building a Safe Room for Your Home or Small Business* (Federal Emergency Management Agency 2014f), "Having a safe room in your home or small business can help provide near-absolute protection for you and your family or employees from injury or death caused by the dangerous forces of extreme winds. Near-absolute protection means that, based on our current knowledge of tornadoes and hurricanes, the occupants of a safe room built according to the guidance in this publication will have a high probability of being protected from injury or death. Our knowledge of tornadoes and hurricanes is based on numerous meteorological records as well as extensive investigations of damage to structures from extreme winds. Having a safe room can also relieve some of the anxiety created by the threat of an oncoming tornado or hurricane." See also ICC 500 and ICC 600 (International Code Council 2014a, b).

*FEMA P-361: Safe Rooms for Tornadoes and Hurricanes: Guidance for Community and Residential Safe Rooms*, Chapter A-3 offers cost estimates for adding safe rooms to new buildings, and some guidance for performing a BCA. For example, its authors estimate that to "design and construct a portion of a new building to resist 250-mph winds from a 140-mph basic wind speed" would add 5% to 7% to the construction cost of the building. The cost is "associated primarily with additional cost of structural elements and envelope opening protection."

**City of Moore Code Enhancements.** In 2014 the City of Moore, Oklahoma, after experiencing a third deadly tornado in 15 years, adopted enhancements to the 2009 IRC that effectively increased design wind speeds from 90 mph to 135 mph and added 12 detailing requirements (City of Moore, 2014a and Ramseyer and Holliday, 2014). See City of Moore Municipal Code, Part 5, Chapter 2, Article A Section 5-204.C as of June 18, 2014, for the city's modifications to the 2009 IRC (City of Moore 2014b). They are also duplicated in Appendix C of the Interim Study.

**IBHS FORTIFIED Home.** The Insurance Institute for Business & Home Safety (IBHS) offers a suite of design standards labeled “FORTIFIED Home” that aims to better protect existing and new buildings from hurricanes, hail, and high winds relative to the minimum requirements of the IRC.<sup>13</sup> Each of its three new-building standards, FORTIFIED Home Hurricane Standards (Insurance Institute for Business & Home Safety 2012), FORTIFIED Home High Wind and Hail Standards (Insurance Institute for Business & Home Safety 2015a) and FORTIFIED Home High Wind Standards (Insurance Institute for Business & Home Safety 2015b) provide three optional levels to exceed I-Code design requirements. Each set of standards has a bronze, silver, and gold designation, with silver aiming for generally greater protection than bronze, and gold better than silver. The gold hurricane designation, for example, aims to “minimize damage and loss resulting from a [Saffir-Simpson Hurricane Wind Scale (SSHWS)] Category 3 hurricane.” FORTIFIED Homes involve the following enhancements:

1. Improve roof sheathing attachment and roof deck sealing (bronze, silver, and gold).
2. Sheath gable end walls, if necessary (bronze, silver, and gold).
3. Improve the attachment of outlookers at gable ends (bronze, silver, and gold).
4. Reduce chances of attic ventilation system failure (bronze, silver, and gold).
5. Protect all openings (glazed openings, entry doors, and garage doors) (silver and gold).
6. Strengthen gable ends over 4 feet in height (silver and gold).
7. Improve the anchorage of attached structures (porches and carports) (silver and gold).
8. Provide a continuous uplift connection between roof support members, exterior bearing walls, multi-story floors, down to the foundation (gold only).
9. Adequately secure chimneys to the structure (gold only).
10. Ensure that windows and doors meet appropriate design pressures in addition to being protected from windborne debris (gold only).

IBHS has begun development of a standard to address high winds in the central United States that covers a basic windspeed of 140 mph in ASCE/SEI 7-10 Exposure Category B, which comprises most buildings in urban and suburban areas. (The IBC’s basic windspeed for Risk Category II—most buildings—in most of the central United States is Exposure Category C is 115 mph. That basic windspeed is estimated to have a 7% exceedance probability in 50 years.) The IBHS standards and the American Wood Council’s *Wood Frame Construction Manual* (AWC 2015) for 140 mph exposure B include prescriptive load path requirements that are similar to those recently adopted in the Moore, Oklahoma Municipal Code and that appear in Appendix Y of the *Oklahoma Uniform Building Code* (Oklahoma Uniform Building Code Commission 2016).

**IBHS FORTIFIED Commercial.** IBHS also offers a suite of design standards labeled “FORTIFIED Commercial” that aims to better protect new commercial buildings from hurricanes winds relative to the minimum

---

<sup>13</sup> Note that in some locations, state and local requirements exceed those of the IRC, such as those adopted after Hurricane Andrew in Florida’s Miami-Dade or Broward Counties. The authors do not consider these local differences from the IRC, and do not calculate the BCR of exceeding them.

requirements of the IBC.<sup>1</sup> Similar to IBHS FORTIFIED Home, this standard provides three optional levels (Bronze, Silver, and Gold) to exceed I-Code design requirements. FORTIFIED Commercial involves the following enhancements:

1. Roof-related components and connections shall meet ASCE 7 wind load requirements with an additional factor of safety (as defined by IBHS) (bronze, silver and gold).
2. Protect glazed openings to minimize water and wind/water pressures intrusion (silver and gold).
3. Design wall systems for code-specified wind pressure resistance and impact resistance similar to that for protected glazed openings (silver and gold).
4. Design exterior entry doors for code-specified wind pressure resistance and are impact rated (silver and gold).
5. Elevate electrical and mechanical equipment and connections above the 500-year flood level or 3 feet above BFE. Electrical connections should also be installed with a transfer switch or docking station (silver and gold).
6. Provide a continuous uplift connection between roof support members, exterior bearing walls, multi-story floors, down to the foundation (gold only).
7. Install backup power that capable of powering critical electrical systems that maintain vital business operations (gold only).

### 3.4.2. Options to Exceed Minimum Flood Design Requirements

The most recognized, organized effort to mitigate flood damage to buildings in the United States is the FEMA NFIP. The NFIP insures property from flood damage and promotes flood risk mitigation strategies. In voluntarily participating communities (counties, municipalities, and tribal nations), buildings that are newly constructed, significantly improved, or significantly repaired must comply with NFIP requirements. Communities also have the option to adopt the IBC, IRC, and the IEBC (International Code Council 2015d).

While acquisition is identified as the most effective mitigation strategy in terms of eliminating residual risk to the structure and ongoing risk to emergency responders (Association of State Floodplain Managers 2014), one of the main flood-mitigation strategies in the NFIP regulations and I-Codes is that buildings in the riskiest flood zones be elevated 1 foot above the height of water expected in the 1% annual chance flood zone, known as the BFE. Such elevation above BFE also is called freeboard. Additional requirements exist for adding freeboard for critical facilities depending on the type of facility and flood zone (International Code Council 2014c, Federal Emergency Management Agency 2013b). Communities that use I-Codes have the option to establish a DFE that exceeds I-Code requirements (International Code Council 2014c).

In addition, FEMA offers design requirements for other modifications to reduce flood damage (Federal Emergency Management Agency 2015a, b). Options include dry floodproofing to prevent water from entering buildings; elevating sensitive equipment to be less likely to experience flooding; and designing lower levels to allow flooding without damage. Walls or levees offer yet another option.

## NATURAL HAZARD MITIGATION SAVES:

According to NFIP requirements, flood damage-resistant materials must be used for construction below the BFE. Flood-resistant materials are able to withstand at least 72 hours of flooding without sustaining significant damage (Federal Emergency Management Agency 2008b). There are five classifications of flood damage-resistant materials, and only Class 4 and 5 materials can be used below the BFE in the SFHA.

A 2014 nationwide FEMA study found that NFIP floodplain management practices avoid \$1.87 billion in damages annually (Federal Emergency Management Agency 2014a). Including model building codes as part of the NFIP would further reduce losses from flood and other hazards and also benefit land use planning (Federal Emergency Management Agency 2013c). The most significant benefit of implementing building codes would likely come from elevating buildings located in flood zones. Multiple FEMA studies (Federal Emergency Management Agency 2014a, 2014b, 2013c, 2008a, Jones et al. 2006) have found that adding freeboard is one of the most effective ways to reduce losses in the most hazardous flood zones. Since NFIP requirements have been implemented, hundreds of thousands of buildings have been built to its minimum levels, while relatively few have included extra freeboard (Federal Emergency Management Agency 2013c).

Over 22,000 communities participate in the NFIP (Federal Emergency Management Agency 2016a). Approximately 70% of NFIP communities already use I-Codes (Federal Emergency Management Agency 2019a). In addition, 34 states have adopted I-Codes statewide. Many of the states with mandatory enforcement are on the east and west coasts. In the remaining 16 states, approximately 87% of communities that are in the SFHA participate in the NFIP, and about 75% of them have adopted I-Codes (Federal Emergency Management Agency 2019a, Federal Emergency Management Agency 2019b). If I-Codes became a requirement at the federal or state level, these states would need additional resources to administer the building codes, train personnel to do so, and support increased coordination between state, local, and federal agencies. Implementing I-Codes in the NFIP would initially increase costs in areas that do not already use them, but in the long term, implementation would increase property values, reduce hazard losses, reduce insurance rates, and improve the financial stability of the NFIP (Federal Emergency Management Agency 2013c). Rural communities may have fewer resources and need more third-party options for code enforcement, but the benefits are similar to those in urban communities (Federal Emergency Management Agency 2013c, White House 2016).

Data from the NFIP's Community Rating System (CRS) can be used to identify communities that have additional elevation requirements in states that do not enforce a statewide building code. Such communities are most common in the southeastern (especially Florida) and the WUS, along with a few communities in the Midwest and Northeast (Federal Emergency Management Agency 2014b).

Elevating a residential building typically costs tens of thousands of dollars, and adding freeboard might add approximately 1% of the total construction cost per foot of elevation, although flood insurance premium discounts can offset the costs of additional freeboard within a few years (Federal Emergency Management Agency 2013c, 2008a). Note that insurance premium discounts can be complex and nuanced when pre-flood insurance rate map (FIRM) and post-FIRM rates are taken into account. A report



## NATURAL HAZARD MITIGATION SAVES:

for FEMA (2008a) found that 1 to 2 feet of additional freeboard was almost always cost effective for the 1% annual chance flood, and three to four feet was cost effective in some situations. Adding 1 to 2 feet of freeboard also earns a larger reduction on NFIP premiums. Adding 3 to 4 feet does not earn a major reduction compared to 2 feet (Federal Emergency Management Agency 2010a). Additional freeboard can also mitigate against risk associated with error or uncertainty in flood risk maps and risk associated with climate change, making buildings more likely to withstand a particularly severe flood. FEMA pilot studies have indicated that 1 to 2 feet of additional freeboard could save a medium-size city, such as Charleston, South Carolina, tens of millions of dollars and save over \$10 billion across FEMA Region IV (the southeastern United States) if the entire region experienced the 1% annual chance flood. In FEMA Region IV, 42% of buildings already had freeboard (Federal Emergency Management Agency 2014b). Table 3-4 recaps the foregoing options.

**Table 3-4:** Flood damage mitigation strategies and general cost effectiveness, based on Federal Emergency Management Agency (2015).

Option	Cost	Damage reduction	Measure lifetime
Building elevation or fill basement	Moderate to high	High	30-50 years
Flood openings	Low	High	15-20 years
Elevate utilities	Low to moderate	Moderate	15-20 years
Flood wall or levee	High	Moderate	50-100 years
Dry floodproofing	High	Moderate	15-30 years
Flood-resistant building materials	Moderate	Limited	10-20 years

Some developers are already implementing additional elevation as one of the key strategies for mitigating future flooding impacts. The area in and around Long Island, New York offers many examples where developers are choosing to exceed state and local requirements by including additional elevation to protect their investments from future flooding. For example, on an East Rockway waterfront property previously occupied by a marina destroyed in Hurricane Sandy, the Beechwood Organization is elevating 84 new condominiums over parking, placing all mechanical equipment on roofs, and other similar measures. The additional efforts that exceed state requirements cost approximately \$5 million. Likewise, in Glen Cove, RXR Realty is raising the ground level of a 56-acre waterfront development, Garvies Point, by 6 to 10 feet. In its Shipyard project in Port Jefferson, the Tritec Real Estate Company is elevating the 112 apartments over a parking garage and installing drainage pumps in the garage, even though the waterfront complex is located outside the designated flood plain. In downtown Riverhead, the Community Development Corporation of Long Island and Conifer Realty are building 45 apartments that will be on the second floor or higher to protect them from floods. The electrical systems will be at least 2 feet above the height of 1% annual chance flooding (McDermott 2017).

Besides increasing elevation, flood openings are the only strategy that can be implemented at the single-building level that FEMA (Federal Emergency Management Agency 2015a) has estimated to have a high potential to reduce damage. Flood openings can be used to meet IBC requirements. They not only have a lower cost than elevation but also have a lower expected lifetime. Filling in basements, abandoning a lower floor, and elevating the lowest interior floor all have similar costs to building elevation, although these measures may not meet all codes. Using flood-resistant materials has limited potential to reduce damage. Construction of walls or levees around a building is a high-cost, long-lasting measure that may be effective in reducing damages (Federal Emergency Management Agency 2015a). However, there are limits on how high walls and levees can be. They may not be high enough to prevent damage, and they must be maintained. Also, nearby terrain and geotechnical conditions may make walls and levees impractical.

In light of the advantages and disadvantages of the options considered here, additional freeboard seems to warrant the most attention for the portion of the Interim Study concerned with exceeding minimum flood design requirements.

### 3.4.3. Options to Exceed Minimum Earthquake Design Requirements

**Option 1: Adopt I-Codes where no code is currently required.** Communities that do not adopt or enforce the IBC and IRC, or who adopt them but weaken the disaster-resistant aspects, could adopt the I-Codes without weakening the disaster-resistant aspects, and enjoy the benefits of the mitigation already provided by those codes. There are jurisdictions across the United States that do not adopt the I-Codes in full, including those in the Central and Eastern United States (CEUS) where seismic risk is less widely appreciated. The lack of modern building codes with seismic code provisions intact in those places poses a particularly acute problem. Furthermore, adoption and enforcement of modern building codes is not a one-time process. It must be continuously maintained. Many jurisdictions across the United States face budgetary challenges. Building codes and building departments are often threatened with pressure to lower costs to promote development. The pressure threatens a building code system funded to support modern adoption and enforcement of codes and training.

**Option 2: Stronger.** Porter (2016a) explores an option for seismic design beyond life safety: designing all new buildings with a seismic importance factor of 1.5, e.g., making them 50% stronger than what ordinary buildings are required to be under the requirements of the 2015 IBC. Making buildings stronger makes them less likely to collapse. One could make new buildings stronger than ASCE/SEI 7-10 requirements by a factor of 1.25, 1.5, or some other higher value, depending on material, location, and other considerations. For example, there is evidence from the Consortium of Universities for Research in Earthquake Engineering (CUREE)-Caltech Woodframe Project (Porter et al. 2006), that stronger design can be cost effective, especially near large active faults.

Some entities routinely require new buildings to be stronger than code requirements, such as Caltech had for three decades. Caltech dropped the use of a 1.5 importance factor around 1997. Caltech Design and Construction (2014) justified the change based on improvements in the 1997 *Uniform Building Code* (UBC).

A Caltech professor explained, “The building code caught up with what we were doing. The newer designs seemed strong enough (we require pushover curves), so the emphasis shifted to other things such as shearwall layout and using improved technology such as non-buckling braces.” (J. Hall, written communication, October 24, 2017.) At least two consulting clients of project team members also required some new buildings that they build and occupy to exceed code-minimum strength requirements.

Some readers may object that strength and stiffness generally go together, or that it is rarely possible to make a building 50% stronger without also making it stiffer. Reinforced concrete and reinforced masonry shearwall buildings largely derive their shear strength from steel reinforcing and their stiffness from concrete or mortar. One can add steel to increase their strength without significantly increasing stiffness. Such buildings are common throughout the United States. Similarly, the strength of woodframe buildings is commonly limited by connectors and their stiffness commonly controlled by sheathing. Strength and stiffness do not increase in proportion to each other in these common building types.

**Option 3: Stronger and Stiffer.** As a closely related alternative to strength, engineers could design new buildings to be both stronger and stiffer than ASCE/SEI 7-10 requires, by a common factor. For example, engineers could design a new building to resist shaking of 1.25 times what ASCE/SEI 7-10 requires, and to be commensurately stiffer as well. (More precisely, to deflect less at design-level shaking.) One could set the requirement at 1.25 times, 1.5 times, or some other value possibly as high as 5.0 or even higher, again depending on materials, location, etc. Compelling advantages of the strength-and-stiffness option include reducing collapse (and, by extension, the red-tagging and yellow-tagging of buildings) and reducing repair costs, since much of the costly (if not life-threatening) damage that buildings experience in earthquakes results from excessive deformation.

Again, the strength option would probably tend to produce greater stiffness, since providing greater strength tends also to provide greater stiffness, but the strength-and-stiffness option would ensure and control the increase in stiffness. Note that increasing stiffness can aggravate some aspects of damage, especially to acceleration-sensitive components, even as it reduces damage to the (generally more costly) drift-sensitive elements. Greater stiffness can also increase earthquake forces on the building, especially for mid- and high-rise buildings.

**Option 4: Performance-based.** A third option: engineers could design new buildings using performance-based earthquake engineering, for example, using FEMA P-58 (Federal Emergency Management Agency 2012d). FEMA P-58 provides an analytical method to estimate building performance in terms of repair costs, life-safety impacts, and loss of function, and to iterate design to achieve the owner’s performance goals. Engineers can finely tune the structural and nonstructural design. Except in cases of the simplest buildings, regular in both plan and elevation, a reasonably accurate FEMA P-58 analysis requires a nonlinear dynamic structural model. It is probably only practical for a modest subset of buildings: large ones built for owners who intend to occupy them for decades. It seems impractical to examine the BCR for FEMA P-58 in any kind of general way. It is building-specific and allows the designer to tailor hundreds or thousands of features to achieve any of a variety of performance objectives.

**Other options.** Additional options include various design features: base isolation (e.g., Mayes et al. 1990), supplemental energy dissipation (e.g., Constantinou et al. 1998), buckling-restrained braced frames (e.g., Sabelli et al. 2003 and NIST 2015), rocking structural systems, and energy-dissipating structural connections (e.g., Christopoulos et al. 2002). These all offer promise as techniques to reduce damage, but they are all somewhat specialized, applicable to one or a few classes of building, and not to the general building stock (GBS).

### 3.4.4. Complying with the IWUIC

Fire hazard exists in several different environments: urban, rural, and the contact between these two, which is called the wildland-urban interface (WUI). Fire also aggravates other perils such as earthquakes, floods, and tropical cyclones. WUI fires have recently caused record-setting losses. For example, California's 2018 wildfire season proved to be the most destructive and deadly one on record. As of early December, more than 8,000 fires burnt an area in excess of 1.8 million acres, the largest burned acreage recorded in a California fire season (National Interagency Fire Center 2018a) and destroyed more than 24,000 structures (National Interagency Fire Center 2018b).

Historically, building codes have been dominated by urban fire risk reduction since the Great Fire of London in 1666, and enhancements continue to be made for the reduction of this hazard. Examples of historic code enhancements abound and are too numerous to detail here, but a few examples included requiring non-combustible roofing materials (whether outlawing thatched roofing in London after the Great Fire and in 18th century Japanese cities, or outlawing wood shake roofs in Los Angeles in the 1970s), requiring fire stopping in U.S. wood frame buildings in the early 20th century, requiring panic bars and unlocked exits in U.S. public assembly buildings (as a result of the 1911 Triangle Shirtwaist Fire in New York), and requiring enclosed stairways and sprinklers in high-rise buildings (the latter requirement still incomplete in many jurisdictions).

Moving to today, the WUI fire risk in the United States has only relatively recently become recognized as quite severe. The ICC first promulgated the IWUIC (International Code Council 2015c) in 2003. Uptake has been sparse. Even though a large part of the country is at risk, only about 10% of the 70,000 communities in the United States at risk of wildland fire have yet to adopt the code (IAWF 2013). According to IAWF (2013), over 220 million acres (twice the area of California) have been designated as high-risk from WUI fire. These areas contain 46 million single-family homes, several hundred thousand businesses, and more than 120 million people (38% of the U.S. population). Furthermore, the potential for increased population within the WUI is large: only 14% of the available WUI lands in the WUS have been developed, leaving 86% available for development. Nationally, those figures are 30% developed, with 70% remaining to be developed. And the U.S. population is actually moving into the WUI. Since 1990, the United States has experienced an unprecedented conversion-growth rate of 3 acres per minute, 4,000 acres per day and close to 2 million acres per year of conversion from wildlands to WUI. Losses because of WUI fire are not merely theoretical. Over 38,000 homes have been lost since 2000, with financial loss of WUI fires in 2009

of approximately \$14 billion. The costs for firefighting (not losses) exceed \$4.7 billion per year, and many other loss costs are not generally accounted for (IAWF 2013).

The WUI fire situation differs from flood, earthquake, or wind in that it has only been systematically addressed in the past few decades. In light of these observations, the project team chose to estimate the benefits and costs of complying with the 2015 IWUIC, rather than seeking to exceed it. It requires, generally, non-combustible roofing and fire-rated cladding, glazing, and underfloor protection; assurance of water supply; defensible space; and, in some places, residential sprinklers.

### 3.5. OPTIONS TO ADOPT OR BETTER ENFORCE MINIMUM DESIGN REQUIREMENTS

Option 1 for exceeding common earthquake requirements (see Section 3.4.3) applies more generally to other perils: a community that does not enforce recent I-Codes with their disaster-resistant features could do so, and better address flooding, windstorm, and other perils. A building owner or developer in one of those communities could build to comply with recent I-Codes despite not being required to do so. The word “recent” matters here. Model building codes with seismic design requirements have evolved greatly since their introduction in the United States with the 1927 UBC, developed by the International Conference of Building Officials (ICBO). Beginning with the 1927 UBC and continuing through the 2018 IBC (International Code Council 2018), model codes have included generally-expanding mandatory requirements to resist both common loads and rare, extreme ones. Similar statements can be made regarding the evolution of the *Southern Standard Building Code*, developed by the Southern Building Code Congress International (SBCCI) 1946 et seq., and the NBC developed by the Building Officials and Code Administrators International, Inc. (BOCA) 1950 et seq.

The model codes have more or less continuously enhanced public safety and property protection, with occasional reductions to better balance reliability and economic efficiency. One could say that disaster resilience begins with building codes. It also seems likely that any effort to design in excess of code requirements would have a higher BCR, the lower the baseline requirements. That is, if a new building is not required to meet the minimum requirements of the 2015 I-Codes, but elects to exceed them, the BCR is likely higher than if the 2015 I-Codes are required and a new building elects to exceed them.

It may be useful to review some recent enhancements. Box 3-1 summarizes enhancements made in the 2015 and 2018 I-Codes relative to the 2012 edition. The rest of this section summarizes some recent research into the costs and benefits of meeting modern code requirements, relative to older codes or no codes.

### Box 3-1. Mitigation Recently Incorporated into the I-Codes and Related Documents

#### Flood

2015 IBC: Refers to standards from *ASCE 24-Flood Resistant Design and Construction* and *FEMA Technical Bulletin 2* (Federal Emergency Management Agency 2008b) on flood-resistant materials. Clarifies determination of substantial damage and significant improvement.

2018 IBC: Adds an appendix with updated design loads for tsunami-resistant design of essential facilities and critical infrastructure.

2015 IRC: Requires 1 foot of additional elevation above BFE for Zones V, coastal A, and A. Clarifies determination of substantial damage and significant improvement.

2018 IRC: Requires that concrete slabs, stairways, ramps, decks and porches in coastal high-hazard areas and Coastal A Zones must either break away so they do not harm structure or be self-supporting.

ASCE 24: Uses Flood Design Class instead of Risk/Occupancy Class. Flood Design Class ranges from 1-4, with 4 being the most critical. There are different elevation requirements for different classes in different flood zones. Requires flood openings in zones V and coastal A for structures such as garages.

#### Wind

2015 IBC: Adds new requirements for tornado shelters in certain buildings in areas where tornado shelter design wind speeds are 250 mph or greater. Clarifies special inspection requirements. Updated reference standard to ICC 500-2014 (International Code Council 2014a).

2018 IBC: Updates tables detailing wind structural design requirements by region to align with the latest wind design standards and to include special wind regions of mountainous terrain and gorges.

2018 IRC: Increases number of king studs in high wind regions to better support headers.

#### Seismic

2015 IBC: Adds seismic design maps for Guam and American Samoa. Adds new diaphragm anchorage requirements. Clarifies special inspection requirements. Reference to 2013 edition of *ASCE 41-Seismic Rehabilitation of Existing Buildings* (American Society of Civil Engineers 2013).

2018 IBC: Requires structural observation of high-rise buildings and Risk Category IV buildings (e.g., hospitals and police and fire stations) to ensure that complex, critical design elements are reviewed and constructed correctly.

SCE/SEI 7-10 3rd printing: Adds new errata corrections, new commentary, and new supplement A.

2018 IRC: Updates seismic maps and corresponding design criteria.

#### Fire at the WUI

2015 IWUIC: Requires non-combustible roof and rated cladding, glazing and underfloor protection, assured water supply, and defensible space (changes relative to 2003 edition).

## NATURAL HAZARD MITIGATION SAVES:

The Insurance Service Office (ISO) Building Code Effectiveness Grading Schedule (BCEGS) rates approximately 19,000 communities on their adoption and quality of enforcement of building codes based on interviews (Wright et al. 2014). Insurers use it to assess how a community enforces its codes. CRS and BCEGS data show the connections between code adoption, enforcement, and losses.

Burby et al. (2000) examined the linkage between building code enforcement and construction activity in central cities, that is, in heavily populated cities at the center of a large metropolitan area. They showed that, “Central cities can capture a larger share of the market for single-family detached housing in their metropolitan areas and also spur commercial rehabilitation if they adopt more business-friendly approaches to building code enforcement. These gains can be achieved without reducing the degree of compliance with building regulations as long as enforcement efforts are strong. In short, one key to increasing economic development in central cities is to foster the right kind of enforcement, rather than having weak enforcement of building regulations.”

Spence (2007) examined the linkage between building code enforcement and outcomes in natural disasters. He found that, “The widespread destruction of buildings in the earthquakes of Kocaeli, Turkey, in 1999 and Gujarat, India, in 2001 was not due to inadequate codes. Destruction occurred because codes were not generally adopted.” His finding supports the assertion that adoption and enforcement of modern codes can prevent catastrophes in large natural disasters.

Burby (2006) drew similar conclusions for U.S. construction subject to hurricanes, citing prior authors who found that “In South Carolina, building code violations were found to be an important cause of damages from Hurricane Hugo in 1989. In south Florida, a quarter of the \$16 billion in insured losses from Hurricane Andrew in 1992 were attributed to Dade County’s failure to enforce its building code.”

NEHRP Consultants Joint Venture (2013) examined the costs and benefits associated with Memphis, Tennessee, adopting the 2003 IBC in place of the 1999 *Southern Standard Building Code* (SBC). Examining six particular buildings, they found that the marginal cost to adopt the IBC’s seismic design requirements rather than those of the 1999 SBC ranged from zero to 1.0%. They found that the 2003 IBC would produce better seismic performance through higher design base shear and detailing requirements that improve strength or structural behavior in the inelastic range of response. They also concluded that, “Requirements for seismic bracing and anchorage of nonstructural components reduce potential for nonstructural damage and loss of building (or system) functionality.”

FEMA (Federal Emergency Management Agency 2014e) estimated losses avoided as a result of adopting and enforcing I-Codes. In particular, the study estimated the average annualized losses (AALs) from flooding, hurricane, and earthquake among 702,000 land parcels in eight southeastern states of FEMA Region IV, with provisions of the I-Codes that differ from prior codes. Flood provisions include requirements for foundation type and additional elevation above BFE. Hurricane provisions include opening protection (shutters), continuous load path, roof-deck attachment, roof cover, and strength and reinforcing in masonry wall systems. Seismic provisions require the design of new buildings considering the

site-specific seismic hazard. The authors of the FEMA study estimated a total of approximately \$500 million AAL avoided at these 702,000 parcels, mostly from hurricane and flood losses avoided in Florida.

Approximately one-third of states have not adopted the I-Codes (Federal Emergency Management Agency 2019a). Doing so comes with up-front costs of potentially higher construction costs and enforcements costs to the local jurisdiction, but provides benefits of greater life safety and property protection in natural disasters, and, perhaps, lower long-term operating and maintenance costs. Code adoption and enforcement could provide buyers with a lower total cost of ownership in many places, and a community BCR in excess of 1.0. If so, the long-term owner who opts to build above code in a community where no code is adopted or enforced would enjoy a BCR greater than those estimated here for an owner whose baseline is the 2015 I-Codes. However, the total cost of ownership to a developer with a short-term ownership horizon might be higher. The developer would bear the initial burden of a higher construction cost, but would own the property too briefly to enjoy savings from lower maintenance costs and lower repair costs after future natural disasters.

The adoption and enforcement of modern codes seems worth special study, but for reasons already stated in Section 3.4.3, the *Report* focuses on exceeding I-Codes where they are already in force. Later examination within the ongoing study may identify benefits and costs of adopting and enforcing I-Codes where they are not currently in force, or where important resilience features are weakened.

### **3.6. ESTIMATING BENEFITS AND COSTS OF ADOPTING CODE REQUIREMENTS**

Studies on the benefits and costs of adopting the I-Codes with respect to reduced flood-related losses primarily focus on building subject to the IBC as discussed in the FEMA report, *Including Building Codes in the National Flood Insurance Program* (Federal Emergency Management Agency 2013b). This study includes a reference to a Hazus pilot study, which indicated \$87-\$163 million in reduced direct and indirect losses for 21,671 structures in a study area for Charleston County, South Carolina. Multiple FEMA studies (Federal Emergency Management Agency 2014a, 2014b, 2013c, 2008a, Jones et al. 2006) have found that adding freeboard is one of the most effective ways to reduce losses in the most hazardous flood zones. While this work did not directly address the I-Codes, however, since the I-Codes primarily address one foot of freeboard for Risk Category II buildings, they provide an appropriate representation of the costs and benefits when adjusted for inflation. The BCRs however should be similar since both the costs and the benefits would both be impacted by inflation.

The Institute's Building Seismic Safety Council (BSSC) examined the costs of adopting seismic provisions emerging in the early 1980s, and found that the new provisions would add an average 1.6% to the construction cost of 52 particular hypothetical buildings in 7 particular cities around the United States (Weber 1985). The average was 0.9% in cities that had already adopted seismic provisions and 2.1% in cities that had not. NEHRP Consultants Joint Venture (2013) performed the most detailed BCA of seismic code adoption of which the project team is aware. Its authors estimated the costs and benefits to redesign



six particular buildings in Memphis, Tennessee, to comply with the seismic provisions of the 2012 I-Codes as opposed to the 1999 SBC (SBCI 1999). Adopting the 2012 I-Codes would add 0 to 1% to the construction cost of the six buildings (and less to the purchase price, since construction cost typically amounts to between 1/3rd and 2/3rds of purchase price). Design to the 2012 I-Codes would increase seismic design base shear of these buildings by a factor that varied between 1.0 and 1.9, with an average strength increase of a factor of 1.6, i.e., 60% stronger. The authors of the NEHRP Consultants Joint venture study estimated annualized repair costs for three of the six buildings. Ignoring the building whose strength did not significantly change under the I-Codes (a hospital), annualized loss to the other two buildings (an apartment building and an office building) was reduced by approximately 50%, as were the estimated collapse probability and number of fatalities.

Recently, Simmon et al. (2018) estimated the BCR of Florida's adoption of the 2001 Florida Building Code (FBC), which took effect on March 1, 2002. They used 10 years of paid insured loss data to estimate empirically that the FBC reduced windstorm insured losses to dwellings (presumably, the building, contents, ancillary structures, and additional living expenses) by \$6 per \$1 of added construction cost.

### **3.7. ESTIMATING BENEFITS AND COSTS OF EXCEEDING CODE REQUIREMENTS**

Simmons et al. (2015) estimated a BCR of approximately 3.2 for the City of Moore, Oklahoma's enhancements to wind design requirements. They estimated benefits in terms of reduced future insurance losses, which would include many, though not all, of the benefit categories in Box 1-2.

Awando et al. (n.d.) studied the IBHS's FORTIFIED Home program. That brief study, based on 321 data points purchased from CoreLogic, estimated the marginal effect of FORTIFIED home construction standards on home resale value while controlling for other housing characteristics. The authors of that study found that switching from a conventional construction standard to a FORTIFIED designation increased the resale value of the home by 6.8%.

### **3.8. EFFORTS TO ESTIMATE BENEFITS AND COSTS OF PRIVATE-SECTOR RETROFIT**

#### **3.8.1. Literature on Flood Retrofit of Private-Sector Buildings**

Mitigation of flood-prone buildings is a balancing act of technical feasibility, reductions in flood vulnerability, homeowner preferences, and cost effectiveness. Available literature shows that multiple flood mitigation options are available for single-family dwellings subject to riverine flooding. Narrowing the options to a practical number to evaluate here required setting some selection criteria. Table 3-5 lists common flood mitigation options and the project team's selection rationale.

Table 3-5: Summary table of flood mitigation options considered for single-family houses subject to riverine flooding.

Mitigation option	Analyzed here	Notes
Acquisition	Yes	This is a common grant mitigation measure and the most effective option because it removes people and property from the floodplain.
Retrofit elevation	Yes	A common mitigation measure for both mitigation grants and privately funded by homeowners. This can bring a building into current floodplain management compliance.
Wet floodproofing basements	Yes	While this measure does not bring a building into compliance, it is common and does not result in homeowners losing storage space for low-value contents.
Wet floodproofing living areas	No	This mitigation option has been used in other parts of the world, such as the UK, but could result in homeowners not evacuating during a flood and could result in contaminants getting into the living space. It will not bring the house into compliance.
Dry floodproofing basement areas	No	Dry floodproofing of basements is allowed by the NFIP in specific communities, but otherwise it will not bring a building into compliance and if not properly done can result in structural damage to the foundation. Homeowners also may be tempted to stay in the house to make sure the pumping systems are working properly, which puts them at risk of being trapped by floodwaters.
Dry floodproofing living areas	No	This measure does not bring a house into compliance and for many wood-frame structures is impractical. If improperly engineered, it can lead to significant structural damage. Homeowners also may be tempted to stay in the house to make sure the pumping systems are working properly, which puts them at risk of being trapped by floodwaters.
Emergency measures and sandbagging	No	House wrapping (plastic films), sandbags, and other measures that are temporary are difficult to assess in their reliability to be properly implemented or engineered. The measures widely vary in effectiveness and costs.

## NATURAL HAZARD MITIGATION SAVES:

Mitigation option	Analyzed here	Notes
Ring levees and flood walls	No	These measures can be overtopped by floodwaters, they can change the flood conditions for surrounding buildings, and they must properly be engineered to be effective. They also do not bring a building into compliance.
Elevating air conditioners or heat pumps	Yes	This measure alone may not bring a house into compliance, but it is inexpensive.
Relocating ductwork	Yes	This measure alone may not bring a house into compliance. However, ductwork commonly is damaged in flooding that may not reach the lowest floor elevation. Depending on the flood conditions, it may require repeated replacement over the life of the house.
Relocating basement/crawlspace furnaces and/or water heaters	Yes	This measure alone may not bring a house into compliance. Furnaces and water heaters located in basements and crawlspaces could require frequent replacement depending on flood conditions.

FEMA Building Science Branch provides a library of publications that treat flood mitigation and post-flood building evaluation. Several were considered here; see Table 3-5. The study considered that homeowners may want to bring their home into compliance with current floodplain management requirements, which would both reduce their flood vulnerability and flood insurance premiums. Other measures were considered and while they may not bring a house into compliance with the current floodplain management requirements, they are less expensive. Ideally, houses could be removed from the floodplain all together, which is why the project team examined buy-outs.

The two primary resources considered for this study were FEMA P-259, *Engineering Principles and Practices for Retrofitting Flood-Prone Residential Structures* (3<sup>rd</sup> Edition – Federal Emergency Management Agency 2012e) and FEMA P-312, *Homeowner's Guide to Retrofitting: Six Ways to Protect Your Home From Flooding* (3<sup>rd</sup> Edition – Federal Emergency Management Agency 2014g). These guides provide background on retrofit elevation, wet floodproofing, dry floodproofing, flood walls, and ring levees. They also provide some background on retrofits to mechanical and plumbing systems. A third FEMA publication FEMA P-348, *Protecting Building Utility Systems From Flood Damage – Principles and Practices for the Design and Construction of Flood Resistant Building Utility System* (2<sup>nd</sup> Edition – Federal Emergency Management Agency 2017d) is more comprehensive. The technical feasibility of retrofits, whether they will bring a building into compliance, and some cost information can be found in these documents.

FEMA's post-disaster assessments known as mitigation assessment team (MAT) reports also help to understand the effectiveness of these measures. In particular, FEMA P-765, *Midwest Floods of 2008 in*

*Iowa and Wisconsin* (Federal Emergency Management Agency 2009e) provides some background on common damage from flooding to basement areas, living spaces, and mechanical equipment. Other MAT reports for hurricanes such as Sandy (FEMA P-942), Katrina (FEMA 549), and Isaac (FEMA P-938) provide context for retrofit elevation and mechanical and plumbing retrofits. These MAT reports also resulted in recovery advisories that contain recommendations on how to properly implement some of these retrofits.

FEMA 480, *Floodplain Management Requirements* (Federal Emergency Management Agency 2005b) and the *National Flood Insurance Program Flood Insurance Manual* (October 2018 Edition) provide valuable information on compliance with local floodplain management requirements and calculating insurance rates. FEMA's *Hazard Mitigation Assistance Guidance* (Federal Emergency Management Agency 2015) provides FEMA grant criteria.

FEMA technical bulletins provide information on retrofit costs and design requirements. These include NFIP Technical Bulletin 1, *Openings in Foundation Walls and Walls of Enclosures* (Federal Emergency Management Agency 2008e) and NFIP Technical Bulletin 2, *Flood Damage-Resistant Materials Requirements* (Federal Emergency Management Agency 2008f). Technical Bulletin 1 provides information on the required number of flood openings. Technical Bulletin 2 provides a list of flood-resistant materials that only require cosmetic cleaning after 72 hours of floodwater exposure.

Two additional documents provide confirmatory information about retrofit design requirements: *Flood Proofing – Techniques, Programs, and References* (U.S. Army Corps of Engineers 2000) and the Hawkesbury-Nepean Floodplain Management Steering Committee (Australia) (2006) publication *Reducing Vulnerability of Buildings to Flood Damage – Guidance On Building In Flood Prone Areas*.

### 3.8.2. Literature on Hurricane Wind Retrofit of Private-Sector Buildings

#### 3.8.2.1. Literature on the IBHS FORTIFIED Home Program to Existing Residential Dwellings

The Insurance Institute for Business & Home Safety (IBHS) FORTIFIED Home program for existing residences (<https://fortifiedhome.org/fortified-home-or-commercial/>) aims to mitigate wind risk to dwellings by strengthening known weaknesses. Several other hurricane wind retrofit programs exist as of this writing. These include Rebuild Northwest Florida (<https://www.rebuildnwf.org/>), SC Safe Home (<https://online.scsafefhome.sc.gov/>), Mississippi Windstorm Retrofit Mitigation Program (<http://www.beaconagencyllc.com/node/7>), and Federal Alliance for Safe Homes (FLASH, <http://www.flash.org/protect.php>), which offers a variety of mitigation suggestions. The project team performed a benefit-cost analysis of the IBHS FORTIFIED Home program because of its nationwide applicability, detailed standards, technical guidance, and because it was developed in conjunction with FEMA's Wind Retrofit Guide for Residential Buildings (FEMA P-804, Federal Emergency Management Agency 2010b). Although specific mitigation requirements between the IBHS and FEMA programs differ slightly, the general framework and mitigation levels are similar.

## NATURAL HAZARD MITIGATION SAVES:

Hurricane wind retrofit programs such as IBHS FORTIFIED Home Hurricane aim to provide a greater degree of damage reduction than the model building codes, which mostly aim to protect life safety. IBHS FORTIFIED Home limits damage by exceeding the minimum requirements of the model building codes with stronger roofing, better door and window protection, stronger exterior cladding, and better protection of the load path between building components and between the building and ground. Anecdotal evidence indicates enhanced mitigation efforts are successful. An Insurance Institute for Business & Home Safety (IBHS) report following Hurricane Charley stated that an unnamed insurance company “insured 5,636 policies in Charlotte County when Hurricane Charley made landfall in 2004. Of these policies, approximately 80% were written for homes that were constructed before the implementation of modern engineering-based design in 1996. The remainder of the policies was written for homes constructed under the SBCCI (Southern Building Code Congress International) high wind requirements or the 2001 Florida Building Code.... Claim frequency was reduced by 60% for homes constructed under the new building codes.... The severity of a claim was reduced by 42% for homes built to the newer codes.” The study identifies the frequency of building component failures from a sample of 270 claims. The incidence of damage to roofs, windows, and garage doors were all lower in modern construction (although an increase in pool cage/screened porch and soffits damage was observed in newer homes), which demonstrates the general effectiveness of improved design.

FEMA 549 (Federal Emergency Management Agency 2006e) presents a mitigation assessment report following Hurricane Katrina, detailing typical structural damage observed after the event. The authors report: “The most common wind-related structural failures observed in light-framed construction were roof framing failures. Failures were observed in both new and old construction. Insufficient attachment of roof sheathing panels to the supporting framing was the most common problem.” Strengthening roof sheathing connections using closer nail spacing will help to mitigate such failures. The FEMA report says that “breaches of the building envelope (such as door or window failure) can result in increased internal pressure, which can damage interior partitions and ceilings and increase the wind load on structural and envelope components.” The use of impact-rated or opening-protection products for glazed openings and garage doors will help mitigate these types of failures. In addition, the assessment team “found structures (including houses under construction) without proper connectors, or with inconsistently spaced, insufficient, or poorly attached connectors.” A continuous load path helps to maintain the structural integrity and prevent any systematic failure due to a single weak point in construction.

Several other post-event assessment reports identify deficiencies and damage associated with outdated, insufficient, or improper construction practices enforced at the time of construction. After Hurricane Hugo, Miller (1990) observed that “80% of the roofs of Charleston were damaged by Hugo’s winds.” After Hurricane Andrew, FEMA (Federal Emergency Management Agency 1992) identified “an absence of or improper installation of framing connections, load transfer straps, or bracing from non-loadbearing walls to connecting wall and roof components was noted. This condition contributed significantly to the primary failure of the framing system.” After Hurricane Irma in Florida in 2017, FEMA (Federal Emergency Management Agency 2018a) observed that “wind-induced structural damage to MWFRS (main wind-force resisting system) was not widespread and, where observed, mostly occurred in older (pre-FBC [Florida

## NATURAL HAZARD MITIGATION SAVES:

Building Code]) buildings.... Overall, newer construction generally sustained much less damage than older construction, so the requirements incorporated in the FBC, along with floodplain management regulations, appear to be working as intended.” The common theme behind all post-event assessment reports is that implementation of modern building codes, when enforced, reduces damage compared with older building codes.

IBHS FORTIFIED requirements for an existing home vary with location, era, and quality of construction. They generally exceed the building-code requirements in force at the time of construction. Homeowners can choose one of three IBHS FORTIFIED programs: FORTIFIED Roof, FORTIFIED Silver, or FORTIFIED Gold. FORTIFIED Roof is the simplest and least expensive. (FORTIFIED Roof used to be called FORTIFIED Bronze, but the name change did not come with material changes.) Each higher designation (Roof to Silver to Gold) offers greater protection at generally higher cost and more reduction in expected damages. Each higher designation includes all the requirements of the lower ones, plus additional requirements.

Each IBHS designation focuses on strengthening susceptible components within the building system. FORTIFIED Roof aims to minimize wind damage to the structure by improving the roof sheathing attachments, preventing water intrusion via a sealed roof deck, ensuring roof covering conditions meet certain standards, and ensuring that roof-mounted vents are high-wind rated. If gable ends are present, they need to be protected against water intrusion. In cases where they are over four feet tall, structural sheathing must be installed and overhangs must be constructed to IBHS standards. FORTIFIED Silver aims to protect the building envelope with the installation of impact-protected shutters at all exterior openings. Soffits are protected to resist water intrusion. Attached structures (such as porches and carports) must be designed to resist wind uplift. Gable ends over four feet tall must be braced to withstand the required design wind pressures. FORTIFIED Gold addresses system-wide deficiencies by ensuring a continuous load path from roof to foundation. Roof-to-wall connections, wall-to-floor connections (if more than one story), and floor-to-foundation connections must be capable of resisting the design loads. If chimneys are present, they must be properly attached to the structure. Figure 3-2 shows sample photos of a retrofit requirement for IBHS FORTIFIED Roof, Silver, and Gold.



**Figure 3-2:** Examples of retrofit measures required by IBHS (A) Sealed roof deck over seams between roof sheathing, as required for FORTIFIED Roof. (B) Shutter installation required for FORTIFIED Silver. (C) Continuous load path required for FORTIFIED Gold. (photos used with permission from IBHS)

### 3.8.2.2. Literature on Engineered Tie-Downs for Manufactured Housing

In response to the passage of the National Manufactured Housing Construction and Safety Standards Act of 1974 (U.S. Code Title 42 Chapter 70 sections 5401-5426), the U.S. Department of Housing and Urban Development (HUD) developed and since 1976 has enforced the Manufactured Home Construction and Safety Standards (U.S. Code of Federal Regulations Title 24 part 3280), which provide minimum design, construction, and other performance requirements for manufactured homes that are designed to be used as dwelling units. Prior to this, no standard regulations existed for manufactured housing. Among other things, the new standards improved the wind resilience of manufactured homes.

In 1994 (following the damage caused by Hurricane Andrew in 1992), the standards were revised to reflect different wind hazard regimes with three zones (Figure 3-3): Zone I reflects “standard wind loads,” which generally means inland from the Gulf and southern Atlantic coasts and inland from the Alaskan coast. Zones II and III comprise high-wind areas (and stricter design requirements) along the Gulf, Atlantic, and Alaskan coasts. Zone-II homes were rated for 100 mph winds (fastest-mile wind speed, yet another way to measure wind speed). Zone III was rated for 110 mph winds. Zone I corresponds to the original 1976 HUD standards. For the present analysis, Hazus fragility functions for both pre- and post-ETS installation are considered for all manufactured homes that comply with the post-1976 HUD standards.

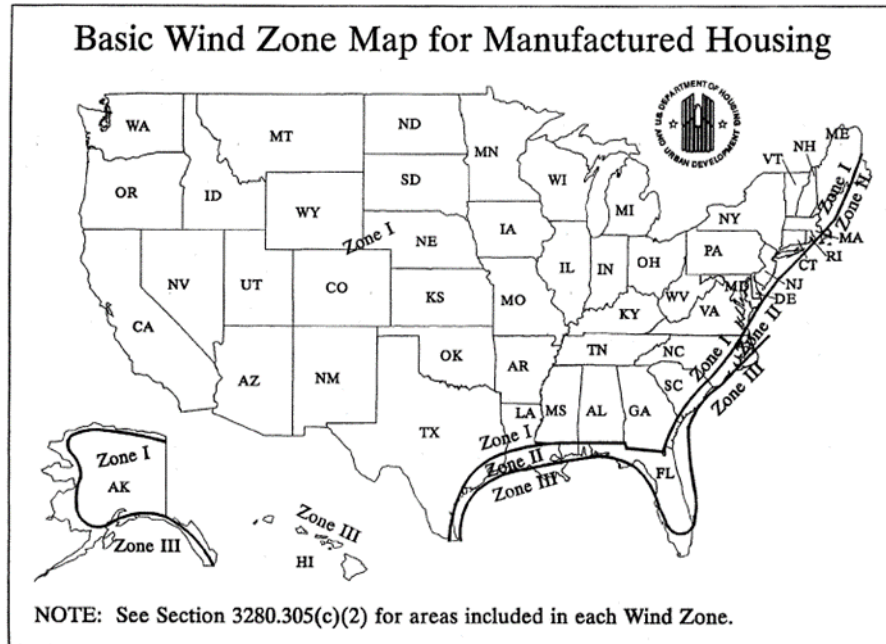

Figure 3-3: Wind zones for manufactured housing (Code of Federal Regulations Title 24 Section 3280.305)

The Manufactured Home Construction and Safety Standards (U.S. Code of Federal Regulations Title 24 section 3285.401) provides guidelines for anchoring manufactured homes to resist high winds.

Specifications provided by the manufacturer must show the assembly is able to resist the overturning and lateral forces due to the wind loads and safety factors specified in sections 3280.305 and 3280.306. For wind zones II and III, in addition to the increased design loads, the tie-down system also must be installed with longitudinal ties (in addition to the vertical ties required in wind zone I). The anchorage systems shall indicate:

- i. The minimum anchor capacity required.
- ii. That anchors should be certified by a professional engineer, architect, or a nationally recognized testing laboratory as to their resistance, based on the maximum angle of diagonal tie and/or vertical tie loading and angle of anchor installation, and type of soil in which the anchor is to be installed.
- iii. That ground anchors are to be embedded below the frost line, unless the foundation system is frost-protected in accordance with sections 3285.312(b) and 3285.404 of the Model Manufactured Home Installation Standards.
- iv. That ground anchors must be installed to their full depth, and stabilizer plates must be installed in accordance with the ground anchor listing or certification to provide required resistance to overturning and sliding.
- v. That anchoring equipment should be certified by a registered professional engineer or architect to resist these specified forces in accordance with testing procedures in ASTM D3953-97, Standard Specification for Strapping, Flat Steel and Seals (incorporated by reference, see section 3280.4).



Some states are attempting to incentivize homeowners currently residing in older manufactured homes to install tie-downs where none are present. For example, in 1997 the State of Florida created the Hurricane Loss Mitigation Program “to act as a specialized, state-funded mitigation program aimed at minimizing damages caused by hurricanes. The program began as an active response to the devastation brought by Hurricane Andrew, specifically to the insurance market in the State of Florida. With an annual budget of \$7 million, provided by the Florida Hurricane Catastrophe Trust Fund, the program is funding activities that promote property resiliency through retrofits made to residential, commercial, and mobile home [sic] properties, the promotion of public education and public information, and through hurricane research activities.” (<https://www.floridadisaster.org/dem/mitigation/hurricane-loss-mitigation-program/>) Of interest from the current study was the “Mobile Home [sic] Tie-Down Program,” which is managed by Tallahassee Community College (2019). The state’s Florida Hurricane Catastrophe Trust Fund pays for the program, with a mission to enhance tie-down and anchoring systems of existing manufactured homes. From 2000 through 2014, approximately 30,496 manufactured homes, with an obligated cost of approximately \$43 million, were tied down with funding from the program. This equates to approximately \$1,500 per installation. However, their data suggest a downward trend in costs with a retrofit in 2014 costing approximately \$1,000 (2018 USD), when adjusted for inflation.

Although installation of an ETS can prevent large losses at modest cost, the system must properly be installed and maintained to perform as intended. After Hurricane Hugo in 1989, Miller (1990) reported in South Carolina that “about 70% of the homes had shifted from their piers; half of those were completely off their supports.” Reasons included pullout from wet surfaces, strap failure, improper attachment to I-beams, and improper installation of ground anchors. FEMA 548 (Federal Emergency Management Agency 2006e) following Hurricane Katrina observed unanchored or improperly anchored homes were prone to wind-related damage. Field photos showed manufactured homes had rolled over or shifted laterally on their piers. Following Hurricane Charley, the Institute for Building Technology and Safety (2005) reported to HUD that manufactured homes’ “tie-down straps were frequently observed to be corroded and rusted.”

While HUD regulations address tie-downs, the department also is aware of room for improvement. A DRM International (2003) report prepared for HUD reviewed the current standards and provided possible future action items, including: more anchor testing; prohibiting continuous tie-down straps from one anchor head to another; improving corrosion protection for straps (doubling the zinc coating on both sides of the strap); and revisions requirements related to frost-line embedment, angles of ground anchor installation, and lateral and vertical chassis and surface attachments.

### 3.8.3. Literature on Seismic Retrofit of Private-Sector Buildings

#### 3.8.3.1. Literature on Soft-Story Wood-Frame Multifamily Dwellings

*The problem of soft-story wood-frame multifamily dwellings.* Weak ground stories in wood-frame buildings led to numerous, notable collapses in the 1971 San Fernando, 1989 Loma Prieta, and 1994 Northridge earthquakes, among others. The ground story of these buildings had fewer walls than upper stories, more

unfinished walls (meaning they lacked interior sheathing, such as gypsum board or lath and plaster), and more openings, largely to allow for garage space and entries. See Section 2.6.3.1 for examples, and chapter 5 of Benuska (1990) for technical details of the Earthquake Engineering Research Institute's reconnaissance of the Loma Prieta earthquake.

EQE International and the Governor's Office of Emergency Services (1995) compiled damage statistics from the 1994 Northridge earthquake, observing from the data that "Multi-family dwellings, in general, performed more poorly than single-family dwellings. ... There is a tendency for larger wood-frame residential structures ... to have higher damage factors [and that] two-story woodframe [sic] construction appeared to have more catastrophic failures and that damage seemed to be more prevalent."

Vukazich et al. (2006) surveyed 7,391 multifamily dwellings in Santa Clara County, finding that 36% had a soft first story. ATC-38 (Applied Technology Council, 2000) surveyed 106 multi-story wood-frame buildings located near strong-motion instruments in Los Angeles after the 1994 Northridge earthquake, finding that 10 of them appeared to have an open first-floor facade, 59 did not, and 37 had unknown conditions, suggesting that 14% of multistory wood-frame buildings in the San Fernando Valley of Los Angeles in 1994 had soft-story conditions, within a possible range of 9% and 44%.

***Local ordinances related to soft-story retrofit.*** Several cities have taken the problem of soft-story failures of multifamily dwellings seriously enough to require seismic evaluation and remediation. The City of San Francisco mandated seismic retrofit through its Earthquake Safety Implementation Program (San Francisco Board of Supervisors, 2013). Likewise, the City of Los Angeles included pre-1980 soft-story wood-frame buildings among its four principal vulnerabilities in its Resilience by Design program (Mayoral Seismic Task Force, 2015). As of March 7, 2019, owners of almost 14,000 Los Angeles buildings had received notices requiring them to comply with the relevant ordinances. Of the 14,000 buildings, plans were submitted for 8,500 buildings. Of those 8,500 buildings, permits were issued for 3,800 buildings, and work has been completed for 1,800 of them (City of Los Angeles Department of Building and Safety, 2019).

Other California cities to enact evaluation or retrofit programs include Oakland (2009), Alameda (2009), Berkeley (2014), Santa Monica (2017), West Hollywood (2017), and possibly others. As of November 2018, the California cities of Pasadena, Beverly Hills, and Culver City were considering similar ordinances. The ordinances generally express the goal of protecting the public's safety and welfare.

***Design and analysis of adding steel frames or wood shearwalls to soft-story wood-frame multifamily dwellings.*** As part of the CUREE-Caltech Woodframe Project, Reitherman and Cobeen (2003) designed an example apartment building for the broader FEMA project to study, including three as-is versions of varying degrees of construction quality, and two versions with seismic retrofit using steel frames and more structural sheathing. Construction costs were estimated by a professional cost estimator. Porter et al. (2002) assessed the seismic vulnerability of the Reitherman and Cobeen (2003) variants, using emerging

methods of performance-based earthquake engineering, and then performed benefit-cost analyses of the retrofit, considering reduced property repair cost as the sole benefit category.

The San Francisco Community Action Plan for Seismic Safety (CAPSS) studied the cost effectiveness of three seismic retrofits (Applied Technology Council 2009a). The CAPSS study examined three mitigation measures for each of four soft-story wood-frame multifamily dwellings. A public advisory committee for the CAPSS project preferred one of the three measures: the addition of cantilever columns at garage door openings, plus added structural sheathing at ground-floor interior walls. See Figure 2-51. The preferred measure produced the best balance of performance improvement and cost. After adjusting the San Francisco costs to an average national location and accounting for inflation between 2008 and 2018, the retrofit cost an average of \$8.60 per square foot (within a range of \$4.40 and \$10.60) in multi-unit dwellings of four to 12 housing units and 5,250 square feet to 22,300 square feet.

Porter and Cobeen (2009) developed seismic vulnerability functions for the four CAPSS buildings, including building repair cost and structural damage states, but not repair duration, additional living expenses, indirect business interruption, deaths and nonfatal injuries, or urban search and rescue costs. They created nonlinear pseudostatic structural models of the four buildings, performed pushover analysis to estimate drift as a function of spectral acceleration response, developed and integrated new component fragility functions for important structural and nonstructural building components (especially straight sheathing and lath and plaster interior finish), estimated repair costs resulting from structural and nonstructural damage, and integrated the model elements to construct the motion-damage relationships. Leading structural engineers peer reviewed the model elements before their use in CAPSS risk analysis.

As part of FEMA's effort to develop the FEMA P-807 guidelines for the seismic retrofit of soft-story wood-frame buildings, Mar and Korolyk (2012) examined a population of approximately 600 simple surrogate structural models representing three particular example buildings with soft-story conditions (to which Mar and Korolyk refer as weak story, to emphasize strength over stiffness). They analyze the building models using multiple nonlinear dynamic structural analyses. They produced guidelines on how to select the optimal ground-story strength that will best protect the building as a whole and not transfer damage to upper stories. The resulting guidelines appear in Federal Emergency Management Agency (2012 SSWF). The guidelines aid in the design of an optimal retrofit, but do not offer particular options, designs, costs, or vulnerability functions.

The NEES-Soft program (van de Lindt et al. 2013) questioned whether FEMA P-807 produced a truly optimal retrofit, and designed and performed both full-scale laboratory shake-table tests and hybrid tests (meaning a combination of laboratory testing and computer simulation) of several alternatives. These alternatives include the use of a so-called distributed knee brace assembly that adds damping to the ground story, a proprietary steel frame produced by the Simpson Strong-Tie Company, and adding cross-laminated timber panels to the ground story. The NEES-Soft project has not produced seismic vulnerability functions for the buildings it studied.

### 3.8.3.2. Literature on Engineered Tie-Downs for Manufactured Housing

Manufactured housing is up to five times more vulnerable than wood-frame houses, according insurance loss data compiled by Steinbrugge and Schrader (1979). In strong shaking, unbraced manufactured homes commonly can fall off their foundations, causing fires, as illustrated in Section 2.6.3.2. For example, Berlin (1980) and EQE International (1994) both report that at one manufactured housing complex in the 1971 Sylmar earthquake, 95% of manufactured homes fell from their supports. California Department of Housing and Community Development (1991) provides a survey of 27 manufactured housing complexes in San Benito, Santa Clara, and Santa Cruz counties, the epicentral region of the 1989 Loma Prieta earthquake. Its authors found that in these parks, 592 out of 2,432 manufactured homes fell from their supports, at per-park rates ranging from near zero to 70%. Manufactured homes on steel piers tended to fare worse than homes on concrete piers, other things being equal. A few manufactured homes were supported on earthquake resistant bracing systems (ERBS), which act as a backup support without providing positive anchorage to the ground. Homes on ERBS performed well.

California Department of Housing and Community Development (1992) supplemented its 1991 study with further research aimed, in part, to quantify “the extent and cost of repairs to, or replacement of, manufactured homes and mobile homes [sic] damaged because support systems failed or were damaged in an earthquake.” The authors reported the average installed cost of engineered tie-downs (\$1000 in 1992). The authors reported: “Although two manufactured homes were structurally damaged beyond repair during the Loma Prieta Earthquake, structural damage to manufactured homes in earthquakes is normally light or nonexistent. Even when the home falls completely to the ground, the structural integrity of the home itself is most often not affected. ... Following the Loma Prieta Earthquake, manufactured home setup contractors charged an average of \$1500 per transportable section just to raise and reset manufactured homes [i.e., \$3,000 for the typical double-wide]. This did not include any repair work required to be done to the home or its accessories. The average doublewide manufactured home owner, whose home fell to the ground, spent an additional \$14,400 repairing the accessory structures, utilities and home.” The \$14,000 figure included replacement of awnings, decks, skirtings, and screen rooms, and repair of utility systems and other miscellaneous repairs.

California Department of Housing and Community Development does not seem to have performed a similar survey of manufactured housing after the 1994 Northridge earthquake, based on a Google search and a search of its web page. EQE International and California Governor’s Office of Emergency Services (1995) reported the number of individual assistance grant applications from occupants of manufactured housing after the 1994 Northridge earthquake (36,487) and that two deaths occurred in manufactured housing. OES (1994) reports that 6,000 manufactured homes collapsed from their foundations.

An unpublished electronic damage database (which one of the project team members, Porter, helped to compile for EQE International and California Governor’s Office of Emergency Services, 1995) contains a few comments about manufactured housing, but not organized in such a way that one can extract damage data. It also contains post-earthquake safety inspection (tagging) data for 42 locations whose use codes

## NATURAL HAZARD MITIGATION SAVES:

(0900, 0901, 0930, and 090E) correspond with manufactured housing. The database, however, lacks sufficient resolution to normalize tag counts (which in any case are too few in number for statistical relevance) by number of dwellings at each location.

Steinbrugge and Schrader (1979) described damage to manufactured homes in the August 13, 1979 Santa Barbara earthquake. They found that “in low intensity but damaging earthquakes such as the 1978 Santa Barbara event, percentage losses to mobile homes [sic] exceed by 5 times that found in neighboring wood frame dwellings.” They reported: “Excluding coach contents, coaches are essentially undamaged when they do not fall from their supports; generally, recaulking of roofs where double-wide units join or where the patio/porch roof joins the coach is the extent of needed repairs. When they fall, then the skirt is normally severely damaged, the frame may be bent, and holes generally are punched through the floor by fallen coach supports. Also, damage will often be severe to the adjacent porches and attached patio awnings which are separately supported on the ground. It is important to note that once a coach falls off its supports, damage and losses will not significantly increase beyond the initial damage. This remains true even for great earthquakes of long duration.” They also reported aggregate insurance claims data for 118 claims: \$228,442 paid, of which about 79% was for structural repairs and 19% was for content losses. The insured value of the 118 units totaled \$4,445,000, suggesting 5.14% average claim as a fraction of total insured value, and \$1,936 per claim, to which one can add the (generally) \$350 deductible that was common at the time, for a total of \$2,286 per claim. For every \$1 of claim to repair the manufactured home, content losses added about \$0.27 to the insured losses.

The Steinbrugge and Schrader (1979) figure for repair of the manufactured home, \$2,286, is small compared with the \$17,400 figure from the California Department of Housing and Community Development (1992). The latter seems the more plausible of the two figures and less potentially influenced by insurance-company data problems and claims-adjustment practices.

Todd et al. (1994a) offered some qualitative observations about the performance of manufactured homes in the 1994 Northridge earthquake, observing that “The vulnerability of mobile homes [sic] to earthquake ground shaking was demonstrated once again by the Northridge earthquake. For example, in a trailer park near the epicenter, at the intersection of Nordhoff Street and Tampa A venue, nearly every home had moved on its supports. These types of homes are usually supported on small concrete and metal base supports. ... These supports provide little resistance to lateral movements, and toppled during the quake. ... The identical failure was observed in the 1971 San Fernando earthquake. It is clear that no improvements in the practice of supporting manufactured homes adequately against lateral loads have been made during the past twenty-three years.”

In unpublished research for the Florida Department of Transportation, a group of researchers including one of the present project team members (Dash) surveyed Florida occupants of manufactured housing and used state-collected survey data to draw some findings that are probably relevant here. The population residing in manufactured homes tends to be older than the general population. Slightly more than 36% of the Florida households consisted entirely of elderly persons (65 and older). An additional 49%

## NATURAL HAZARD MITIGATION SAVES:

of the households included members 65 years of age or older. About 15% of the population were widowers living alone. These are segments of the population that could be categorized as having special needs, especially during emergencies.

At the national level, the American Housing Survey (U.S. Census Bureau 2017-KP1) shows that occupants of manufactured homes nationwide tend to have lower household income: an average of \$44,000 in 2017, compared with \$77,289, for all housing (Figure 3-4). Approximately 29% of households in manufactured housing units have household income below the 2018 poverty level (\$16,000 to \$21,000 for households of two and three people, respectively.) Compounding the fact that they have lower income, many owners of manufactured houses do not own the land beneath the home, so they have less equity and therefore less ability to borrow to pay for repairs. Residents of manufactured housing nationwide, however, do not tend to be older than the general population (U.S. Census Bureau 2017-KP1; Figure 3-5).

Fothergill and Peek (2004), citing several studies, note that people with low income and socioeconomic status tend to experience greater stress following disaster than do people of higher income and socioeconomic status. They do not, however, quantify that effect.

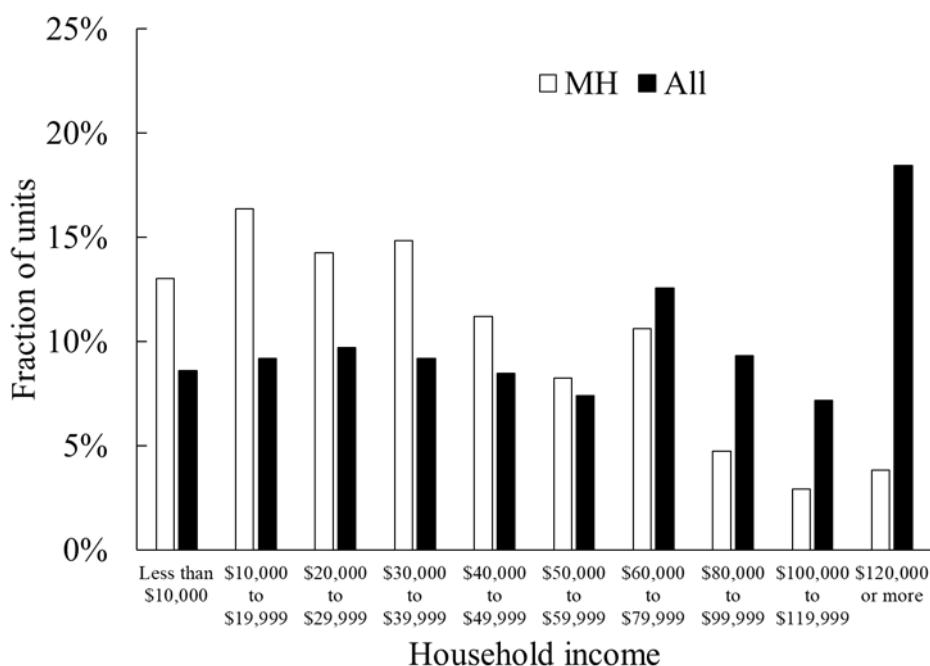

**Figure 3-4:** Occupants of manufactured homes tend to have lower household income than the general U.S. population, according to the U.S. Census Bureau (2017-KP1).

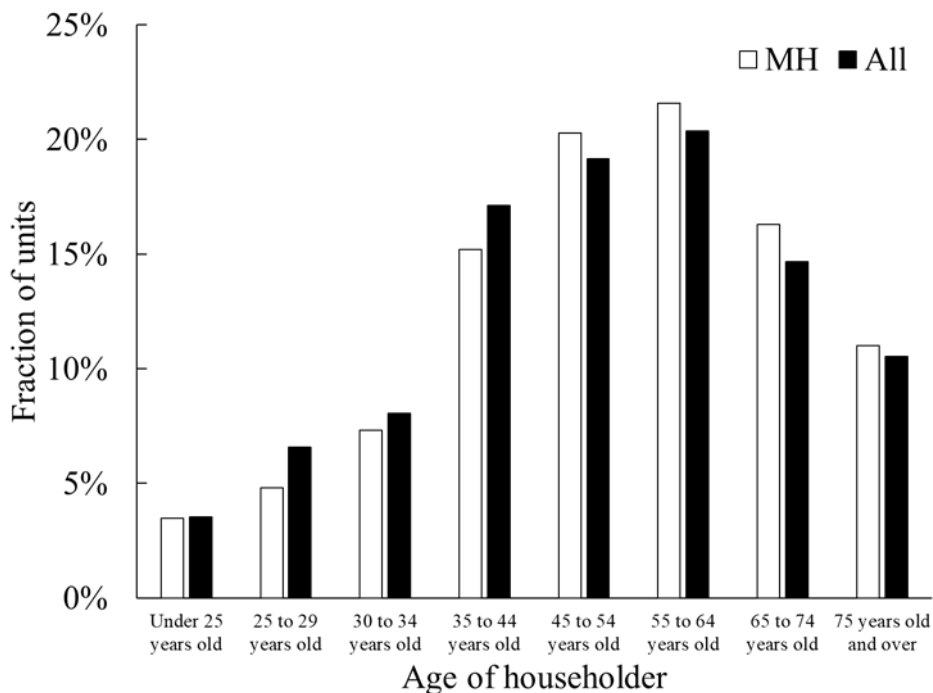
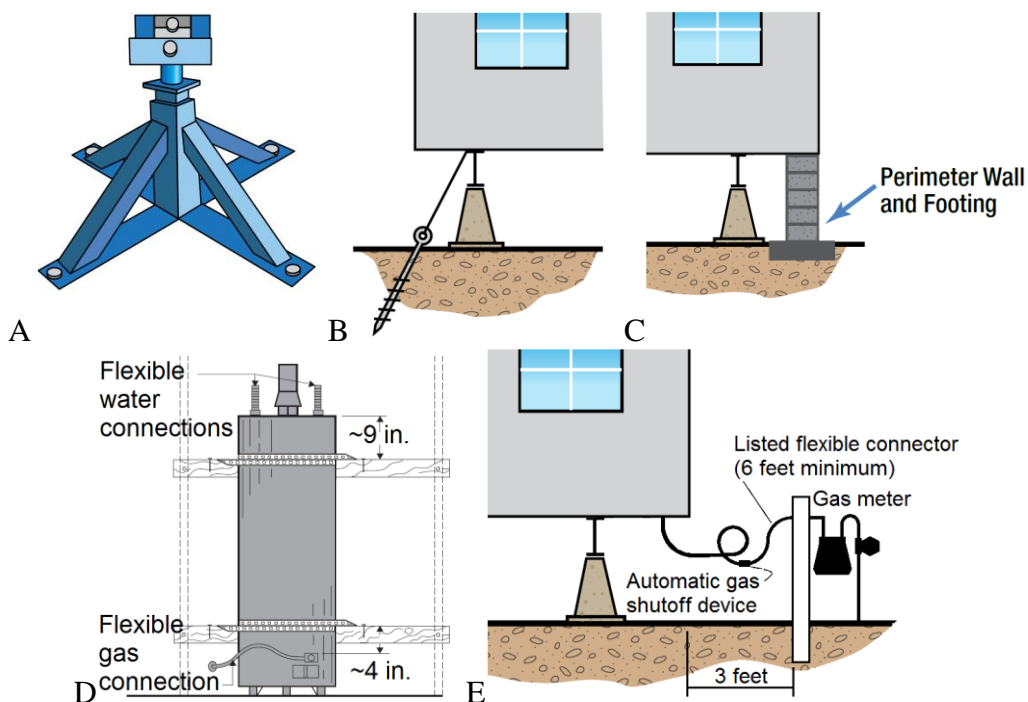

Figure 3-5: Occupants of manufactured homes tend to have the same age distribution as the general U.S. population, according to the U.S. Census Bureau (2017-KP1).

The U.S. Census Bureau’s 2017 American Community Survey (U.S. Census Bureau 2018-KP2) estimates that nationwide, 12% of manufactured homes are not anchored to their foundation. The fraction varies geographically. In California, its estimate is 38%. In Colorado, it is 27%.

In various metropolitan statistical areas, the fractions are as follows: Seattle, Washington, 18%; Portland, Oregon, 31%; Phoenix, Arizona, 21%; Las Vegas, Nevada, 22%; Memphis and Nashville, Tennessee, 12%; Louisville, Kentucky, 4%; Kansas City, Kansas, 23%; and Oklahoma City, Oklahoma, 9%. The American Community Survey is limited in its geographic scope. It does not cover other highly seismic states, such as Utah or South Carolina, or metropolitan statistical areas within them, namely Salt Lake City or Charleston.

There are several ways to improve the seismic resistance of manufactured housing and to reduce or prevent post-earthquake fires. Earthquake-resistant bracing systems (ERBS) act as backup support, usually without providing positive connections between the manufactured house and ground. An ERBS typically costs \$3,000 to \$5,000. Probably more effective and less expensive, an engineered tie-down system (ETS) provides positive connection to the ground and actively resists sideways collapse, costing \$1,000 to \$2,000, according to contractors interviewed by the project team as part of an earlier study (SPA Risk LLC 2014). One can provide a reinforced concrete or reinforced masonry foundation at a much greater cost, anywhere from \$5,000 to \$50,000. When performing any of these actions, it also is probably worthwhile to brace water heaters and add flexible gas connections, together costing \$135 to \$300. See Figure 3-6 for illustrations of these methods.



**Figure 3-6:** Leading options for improving the seismic resistance of manufactured housing and to reduce or prevent-post-earthquake fires. (A) Earthquake-resistant bracing system (ERBS), (B) engineered tie-down system (ETS), (C) perimeter wall and footing, (D) securing water heater, and (E) adding a flexible connection between the gas line and manufactured home, along with an automatic gas shut-off valve. (Images by Henderson Consulting, 2013, and courtesy of SPA Risk LLC, used with permission.)

In 1994, in response to widespread collapse of manufactured housing in the 1994 Northridge earthquake, California amended its Health and Safety Code (California Legislature 1994) requiring tie-downs for new manufactured home installations after September 1994. Because design wind loads generally exceed earthquake forces, the regulation requires the tie-down to resist 15 pounds per square foot of wind pressure (more where the design wind pressure is higher). The act explicitly states its justification and urgency: "To ensure that as many manufactured homes and mobile homes as possible are protected at the earliest possible time from sudden devastation by earthquakes, it is necessary that this act take effect immediately." A number of commercial systems meet the California Health and Safety Code's requirements, e.g., Oliver Technologies Inc. (2007), Tie Down Engineering (2007), and Minute Man Anchors, Inc. (2015).

### 3.8.3.3. Literature on Securing Residential Furniture, Fixtures, Equipment, and Contents

Content damage contributes much of the economic loss in earthquakes. This is because content contributes much of the value to buildings and also some contents are easily damaged. The authors of FEMA E-74 (Applied Technology Council 2011 p. 2-6) estimate that contents add on about 25% to the replacement cost of the construction of an office building. It is common practice in homeowner insurance underwriting to estimate the value of contents at 40% to 75% of the building replacement cost



## NATURAL HAZARD MITIGATION SAVES:

(Insurance.com, 2018). An informal survey by members of the project team among professional engineering colleagues at EQE International in the 1990s suggested that their content replacement costs in homes typically comprise approximately 50% of building replacement costs. Much of this value is rugged: earthquakes tend not to damage soft items such as clothes, books, tables, chairs, sofas, beds, and linens.

Perhaps 10% of residential content value is comprised of fragile items, such as shelving (book cases, freestanding cabinets, and garage storage racks), fragile contents of cabinets and shelves, devices resting on desks or countertops (such as computers, monitors, and kitchen appliances), and water heaters. Figure 3-7 illustrates damage to these component categories. The Associated Press reported (November 30, 2018) that the Mw 7.0 Anchorage earthquake that day reported that “picture frames and mirrors were knocked from living room walls.”

Tenants and owners can reduce content damage with simple mitigation measures. The Earthquake Country Alliance (2019) offers a list of 48 ways to “secure your space,” with a description of the problem posed by one kind of building element and instructions to mitigate the problem. FEMA P-58 (Applied Technology Council 2012) offers fragility functions (which model damageability) and consequence functions (which model the cost of the damage) for each.

One can reduce earthquake damage to these items at relatively low cost and usually without professional help. Several authorities offer detailed recommendations on preventing such damage. FEMA E-74 (Federal Emergency Management Agency 2011 E74) provides a practical guide to reducing the risks of nonstructural earthquake damage, listing “common-sense measures” to reduce earthquake losses from a variety of residential items, such as bookcases, shelving, electronics, water heaters, items on shelves, artwork, and countertop items. The guide offers text descriptions and photos of historic earthquake damage as well as schematic drawings of remediation measures in sufficient detail. Many homeowners can purchase the necessary supplies and perform most of the remediation measures. The U.S. Geological Survey’s (2005) handbook *Putting Down roots in Earthquake Country* and the Earthquake Country Alliance (2018) offers resources for a similar variety of components.

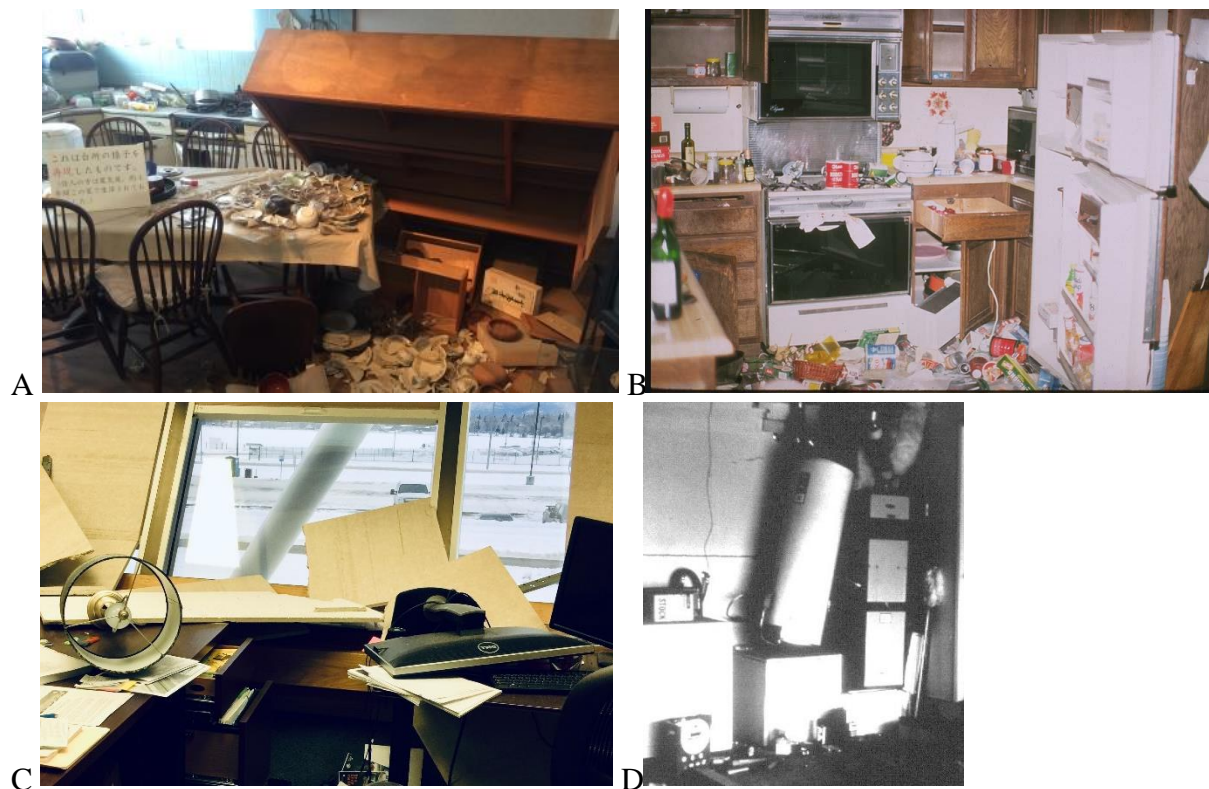

**Figure 3-7:** Damage to contents common to residences. (A) overturned bookcase with fallen contents (Rhiannon Harris on January 22, 2015, with permission; <https://triadfellowship.wordpress.com/2015/01/22/hokudan-earthquake-memorial-park-and-nagoya-flower-market/>) (B) contents spilled from cabinets and countertops in a kitchen near the Northridge Fashion Center after the 1994 Northridge earthquake (Photo Credit: J. Dewey, U.S. Geological Survey.) (C) Overturned desktop contents after the 2018 Anchorage, Alaska earthquake (Alaska Department of Transportation and Public Facilities - CC BY-SA 2.0, <https://commons.wikimedia.org/w/index.php?curid=74853821>), and (D) residential water heater (California Seismic Safety Commission 2005).

The foregoing works do not quantify the damageability of furniture, equipment, fixtures, and contents. However, the authors of FEMA P-58 (Federal Emergency Management Agency 2012d), including one of the project team members (Porter), performed an extensive literature review and supplemental analyses of the damageability of residential furniture, equipment, fixtures, and contents, and developed an extensive fragility database. The database contains fragility information for 400 nonstructural components under various seismic installation conditions.

In the case of benefit-cost analysis of remediating residential furnishings, fixtures, equipment, and contents by the homeowner or tenant, a question arises about whether to include the homeowner or tenant's labor in the cost. The labor to install most remediation measures and cleanup of losses (except overturned water heaters) are likely to fall on the homeowner, who will perceive the effort as a significant expense. It seems

reasonable to include and value that labor. The value of volunteer labor seems most relevant here. Independent Sector (2019) recommends a value of \$24.69 per hour.

In the case of hot water heaters, the Earthquake Country Alliance (2018) advises that securing the water heater can help prevent gas leaks and fires. The advice begs two questions: (1) What fraction of hot water heaters currently are unsecured to the building frame, and (2) If a water heater falls over, what are the chances that it will break its gas line and a fire ignite as a consequence? On the first point, the 2018 International Residential Code (International Code Council 2018) requires only that hot water heaters are installed according to the manufacturer's instructions. California Health and Safety Code Section 19211 (California ND) requires that "all new and replacement water heaters, and all existing residential water heaters shall be braced, anchored, or strapped to resist falling or horizontal displacement due to earthquake motion. At a minimum, any water heater shall be secured in accordance with the California Plumbing Code, or modifications made thereto by a city, county, or city and county pursuant to Section 17958.5." The project team could find no similar requirement in Oregon, Washington, Utah, Missouri, Tennessee, Kentucky, or South Carolina. It seems reasonable to assume that most hot water heaters in California by now are secured to the building frame, and that few are secured in other states.

What happens if a hot water heater falls over? The California Department of Housing and Community Development (1991) reports that fires destroyed two manufactured homes in Watsonville, California, in the 1989 Loma Prieta earthquake, and that "While the cause of the fires ... is not known, it is suspected that the gas piping to either the home itself or to one of the home's gas appliances were ruptured and the escaping gas ignited. Gas appliances within the home are required to be secured in place; however, previous experience indicates that homeowner replacements of appliances often overlook this requirement of HCD and Federal regulations."

Williamson (2000) reports that in the 1994 Northridge earthquake, Southern California Gas Company reported 2,500 overturned water heaters, while the Los Angeles Fire Department reported 21 fires associated with overturned water heaters, suggesting that the chance of an overturned water heater causing a building fire is 0.84%.

Scawthorn et al. (1998) report that the Los Angeles Fire Department estimated that 77 earthquake-related fires in the 1994 Northridge earthquake caused \$12.4 million in property losses (approximately \$21 million in 2018), suggesting a per-ignition property loss (building and contents) of \$273,000 in 2018 USD, which would imply another \$27,000 in additional living expenses, using common insurance ratios of dollars of additional living expenses per dollar of property loss. It also would imply approximately \$14,000 in indirect business interruption, using factors detailed in Appendix K of this report. EQE and OES (1995) report that one fire-related death occurred in the 1994 Northridge earthquake, suggesting on the order of 0.013 deaths per ignition.

Scawthorn (2018) points out that the ignition, growth, and spread of fires after earthquakes is highly nonlinear with earthquake magnitude, because of many factors, such as whether the number of ignitions exceeds the fire department's ability to simultaneously fight them all, i.e., because fires can outnumber

engines. The implication is that the \$273,000 in property losses for each ignition in the 1994 Northridge earthquake might be too small, considering that larger earthquakes might dominate risk. The Northridge earthquake had about 110 total ignitions; Los Angeles Fire Department has about 106 engines. Fire departments in Los Angeles County had about 500 engines in the affected area, and about 500 more engines nearby. Engines outnumbered fires, so there was little fire spread. For a larger event, more fire spread would occur and easily could increase by orders of magnitude. For a hypothetical Mw 7.0 earthquake on the Hayward Fault in the San Francisco Bay Area, Scawthorn (2018) estimated 668 ignitions and \$30 billion in property loss alone, equivalent to \$45 million per ignition, a figure 165 times larger than \$273,000 per ignition.

Finally, it is necessary to estimate the useful life of each mitigation measure. Tops Kitchen Cabinets (2014) suggests that cabinets last on average 50 years. Taylor (2019) advises that tank-type water heaters last an average of eight to 12 years. Average tenure in a home is currently about nine years (U.S. Census Bureau 2016), suggesting that mitigation measures for moveable furnishings have an expected life when first installed of up to nine years.

### 3.8.4. Literature on WUI Fire Retrofit of Private-Sector Buildings

There is substantial literature on retrofit to comply with the International Wildland-Urban Interface Code. Relevant sources include:

- The 2018 International Wildland-Urban Interface Code itself (International Code Council 2017)
- The U.S. Fire Administration's Wildland Urban Interface toolkit ([https://www.usfa.fema.gov/wui\\_toolkit/](https://www.usfa.fema.gov/wui_toolkit/), Figure 3-8)
- The National Fire Protection Association's Firewise USA® website (<https://www.nfpa.org/Public-Education/By-topic/Wildfire/Firewise-USA>, Figure 3-9)
- The Insurance Institute for Building and Home Safety's (IBHS) Prepare for Wildfire website (<https://disastersafety.org/wildfire/>, Figure 3-10)
- Regional websites such as the West Region Wildfire Council in Colorado ([www.cowildfire.org](http://www.cowildfire.org), Figure 3-11) and Oakland Firesafe Council in the San Francisco Bay Area (<http://oaklandfiresafecouncil.org/>, Figure 3-12)

Few authors specifically have examined the issue of costs or benefits of retrofitting buildings to better resist fire in the wildland-urban interface, or the costs and benefits of producing risk information related to WUI fire. Penman et al. (2017) quantified the cost of retrofit in Australian intermix and interface community, finding wide variation in the level of preparedness, although intermix houses were better prepared than those at the interface. Total up-front costs to prepare residents and their homes significantly varied and the financial investment required significantly was higher than residents felt they were able to cover. Penman et al. (2016) found that the largest costs resulted from altering landscaping, which implies that using non-combustible ground cover greatly would reduce ongoing maintenance costs and the present value of retrofit cost.

## NATURAL HAZARD MITIGATION SAVES:

Regarding the decision to create a defensible space, Shafran (2008) modeled the problem as a game played between neighbors in a wildland–urban interface. He found that a household’s defensible space decision depends on the defensible space outcomes at neighboring sites. That is, the decision reflects another aspect of the herd effect in fire risk mitigation. (Herd effect, as used in public health, can be defined as the reduction of infection or disease in the unimmunized segment that results from immunizing a portion of the population.)

Mozumder et al. (2009) studied the value of fire risk information and found that homeowners were willing to pay more for fire risk maps than it cost to produce the maps in the first place, suggesting that homeowners value fire risk information.

Wildland fires strongly can degrade air quality, even at some distance. This degradation can have significant health and economic costs (Bowman et al. 2018; Jones et al. 2016; Kochi et al. 2010, Richardson et al. 2012). Urban areas are not immune from these impacts, as was seen most recently in the 2018 Camp Fire in California (Figure 3-13 and Figure 3-14). While health and economic costs of such impacts can be priced (National Academy of Sciences, Engineering, and Medicine 2017; Prager et al. 2017), these costs largely are attributable to the burning of wildland fuels rather than buildings and their contents. That is, even if all buildings complied with the International Wildland-Urban Interface Code and none of them burned, wildfires still would degrade air quality because most of the smoke and fire byproducts result from burning of the wildland vegetation. Admittedly, if structures were extremely fire-resistant and people sheltered in place, the change would reduce health costs but perhaps only minimally. Economic costs associated with air quality barely would change. Therefore, while WUI fires have significant health and economic costs, the project team ignored air quality costs, since they largely are unrelated to building damage in WUI fires.

## NATURAL HAZARD MITIGATION SAVES:

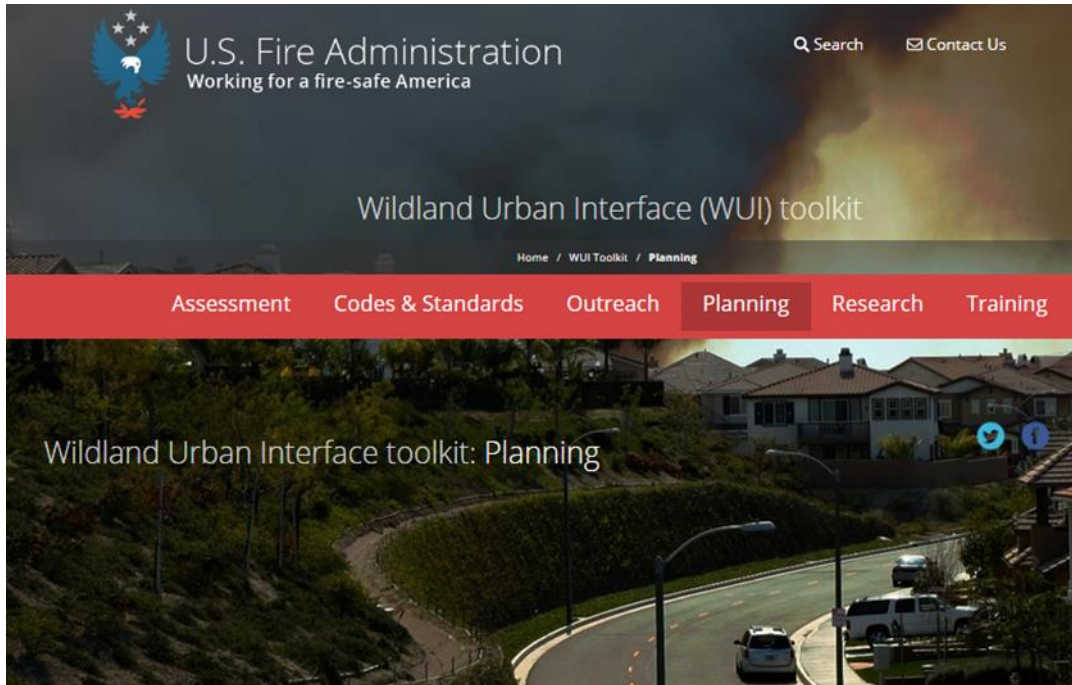

Figure 3-8: U.S. Fire Administration Wildland-Urban Interface (WUI) toolkit website. (public domain).

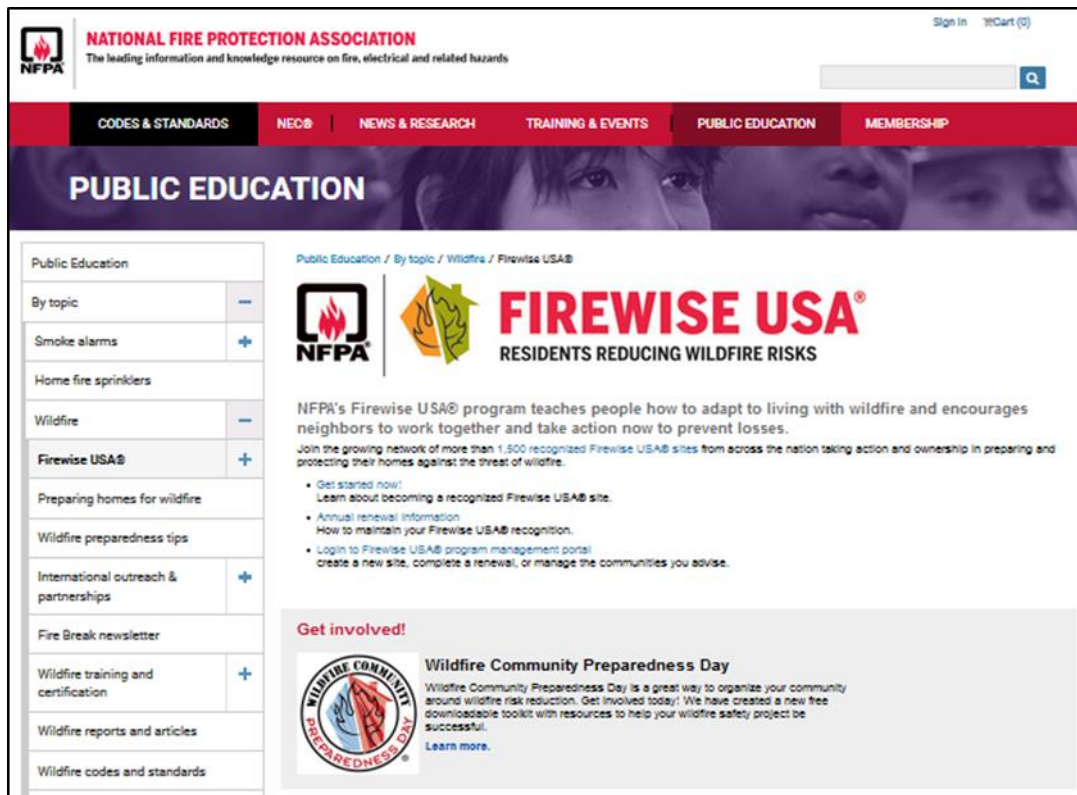

Figure 3-9: National Fire Protection Association Firewise USA website

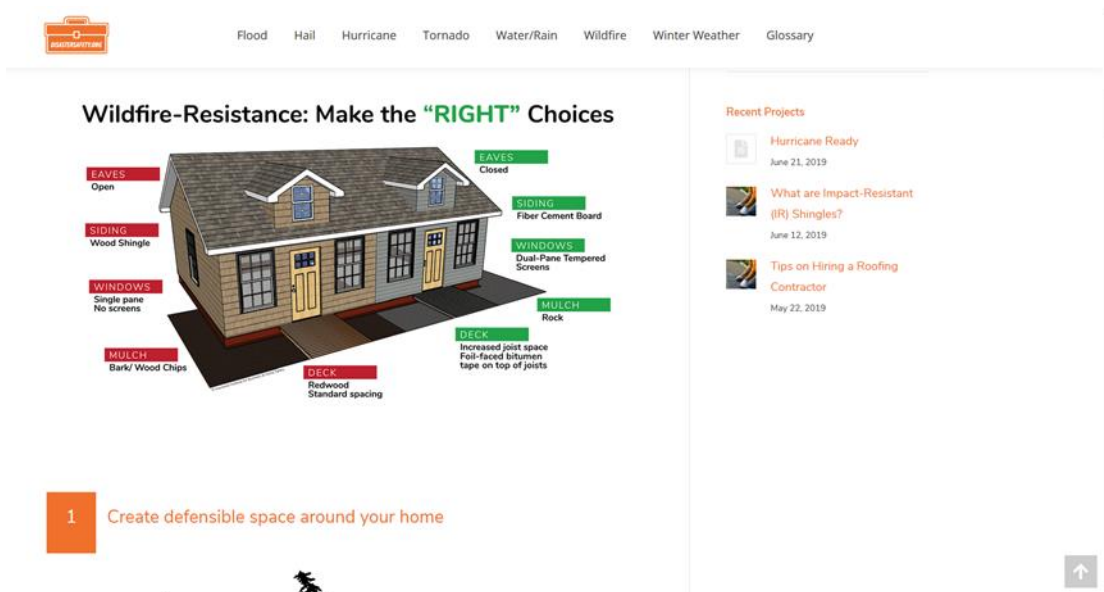

Figure 3-10: Insurance Institute for Business & Home Safety Protect Your Home from Wildfire website

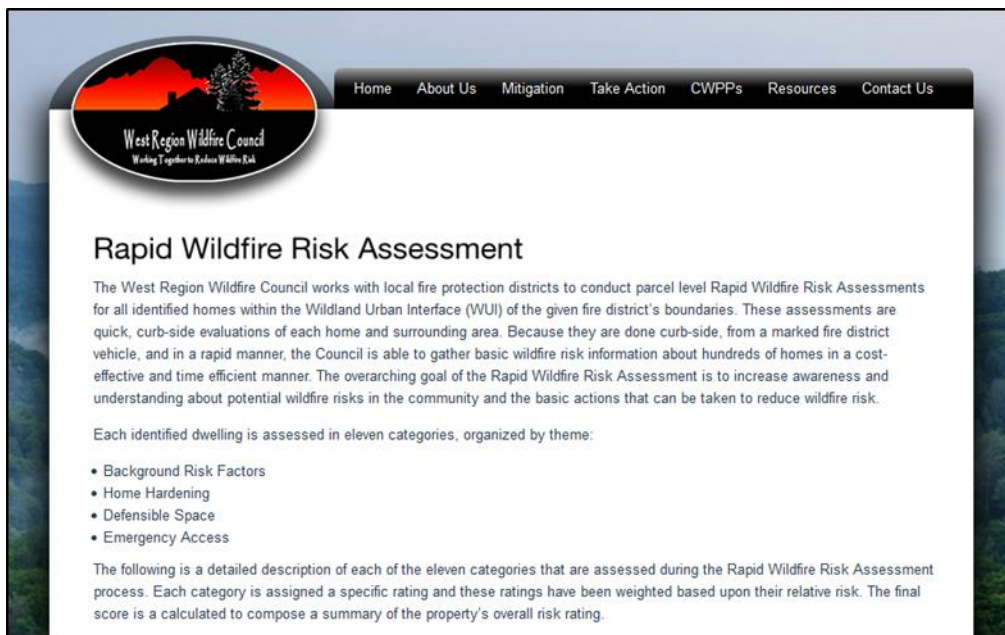

Figure 3-11: West Region Wildfire Council (Colorado) website

## Creating Defensible Space



Creating a buffer between a building on your property and the grass, trees and shrubs, or any wildland area that surround it is essential to improve your home's chance of surviving a wildfire.

Follow the guidelines in this Demonstration Garden to create defensible space on your property.

All properties are inspected by the Oakland Fire Department for compliance on a continual basis throughout the year.

**ZONE 1 NO FIRE ZONE** to reduce the chance of wind-blown embers from a nearby fire landing near the home igniting combustible debris or materials and exposing the home to flames. Extends 5 feet from your structure

- Use rock, gravel, crushed granite or other non-flammable materials adjacent to structure.
- Plant succulents/low growing groundcover no more than 6" tall at least two feet from windows. Keep them well-spaced and free of dead wood.
- Remove vegetation and items that could catch fire from around and under decks.
- Throughout your property, use non flammable mulch such as rocks, stones or wood chips 3" or larger. Mulch should be no deeper than 3".

**ZONE 2 DEFENSIBLE SPACE** to create and maintain a landscape that, if ignited, will not readily transmit fire to the home. Extends 5 to 30 feet from your structure

- Shorter plants (less than 2 feet) are safer than taller plants. If kept green, herbaceous plants (lawn and nonwoody plants) are better choices than shrubs or trees.
- Separate trees, shrubs and vegetation both vertically and horizontally to avoid spreading flames. Well-pruned, maintained trees and shrubs cleared of dead and dying foliage are safest.
- Trim trees regularly to keep branches a minimum of 10 feet from other trees, your roof, or side of home.
- Remove dead or dry leaves/pine needles from your yard, roof and rain gutters.

**ZONE 3 LARGER LOT DEFENSIBLE SPACE** to reduce the energy and speed of wildfire. Extends 30 to 100 feet from your structure

- Space trees/shrubs 4-40 feet depending on the slope of your property to reduce fire spread.
- Prune lower tree limbs at least 6 feet from the ground.
- Maintain clearance of 3x height of shrub to lowest branches of tree as vertical clearance.
- Remove all ground fuels greater than 4" in height. Single specimens are okay if well-spaced, well-pruned and green.

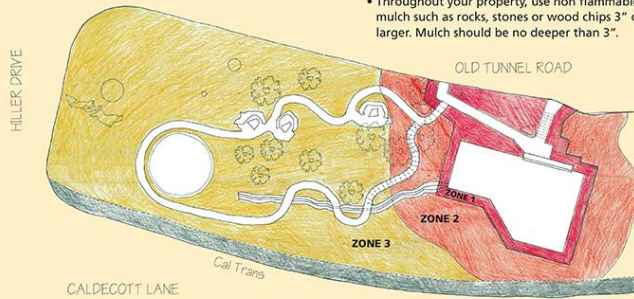

3/2015

## Make Your Home More Fire Resistant

Choose a noncombustible or ignition resistant material when you replace roofs, decks or fences in and around your home. Protect your home by maintaining effective defensible space under and around the structure.



### ▲ Decks

Shown above is a California Chapter 7A compliant decking product (left) and a non-compliant product (right). Both are wood-plastic composite decking products. All heart redwood 2" x 6" decking is also fire resistant.

### ▲

Avoid storing combustibles (paint, firewood, brooms) under the deck and remove combustible furniture and baskets from deck when fire approaches.

### ▲ Windows

Buildings will burn inside from heat and flames outside. Keep trees and shrubs 2 feet from windows. Replace windows with double-paned glass and use non-flammable, heavy drapes of natural fibers. Avoid lace curtains and synthetics.



### ◀ Roofs, Eaves & Soffits

Wind blown embers can easily ignite leaf litter on your roof and shingles, spreading flames to your roof, sidings and into your home. Current building codes require an AAA-rated roof, bird stops for barrel tiled roofs and sealing eaves with soffits made of fire resistant materials.

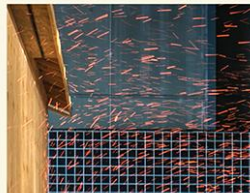

### ◀ Vents in Attic or Crawl Space

Keep flying embers from entering roof and foundation vents by covering with 1/8-inch metal mesh.

From Insurance Institute for Business and Home Safety [www.disastersafety.org/wildfire/](http://www.disastersafety.org/wildfire/)

03/2015

Figure 3-12: Example materials for public dissemination regarding making homes more fire resistive



## NATURAL HAZARD MITIGATION SAVES:



**Figure 3-13:** Camp Fire smoke at the Bay Bridge in San Francisco, California. Left: San Francisco Oakland Bay Bridge on November 16, 2018 during the Camp Fire. Right: same place on October 14, 2018. (Source: James R Morrin Jr CC BY-SA 4.0)

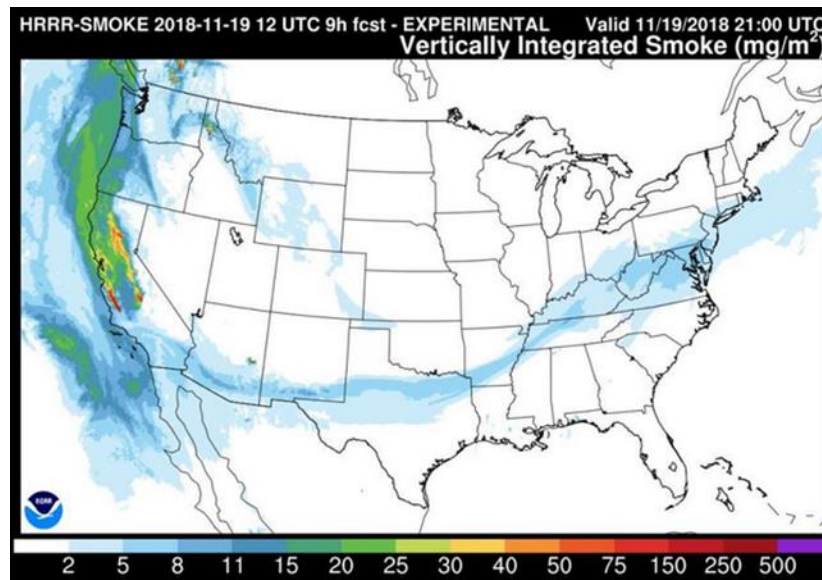

**Figure 3-14:** Camp Fire smoke dispersion across U.S. (Source: NOAA, accessed 20 March 2019 from <https://www.sfgate.com/california-wildfires/article/camp-fire-smoke-noaa-maps-nyc-texas-paradise-13408526.php#photo-16533579>)

### 3.9. EFFORTS TO ESTIMATE BENEFITS AND COSTS OF FEDERAL GRANTS

FEMA requires grantees it is asked to fund to provide BCA for most proposed natural hazard mitigation. To aid those analyses, FEMA developed BCA software. On January 10, 2017, FEMA released the BCA Tool version 5.3.0 to demonstrate cost effectiveness for its Hazard Mitigation Assistance (HMA) grant programs. Some major features include: updated standard economic values utilized in analysis; an aquifer storage and recovery module for drought mitigation; incorporation of climate-resilient mitigation activities, expansion of ecosystem service benefits; updated tornado recurrence information in the saferoom module; and updated hurricane wind and earthquake hazard data sets.<sup>14</sup>

The *2005 Mitigation Saves* study estimated the BCR of FEMA-funded natural hazard mitigation between 1993 and 2003. Rose et al. (2007) offered a synopsis of the study: “The 2005 study performed an independent assessment of the benefits and costs of mitigating hurricane, flood, and earthquake risk, mostly in existing public buildings. That study used sampling to estimate the benefits and costs of a few dozen grants, extrapolated to the population of grants, and found that the \$3.5 billion in mitigation spending will save society about \$14 billion in avoided future building repair costs, content losses, direct and indirect BI, deaths and nonfatal injuries, and environmental and historical value.”

The National Center for Environmental Economics (2010) offered general guidance on BCA. Particularly relevant is its guidance on selecting discount rates. Furthermore, the OMB (Government Publishing Office 2016) provides guidelines on discount rate values based on treasury notes and bonds with various maturities. The discount rate is the price or value of money that reflects the rate at which society is willing to postpone a marginal unit of current consumption in exchange for more future consumption and the marginal social rate of return on private investment (also termed marginal social opportunity cost of capital). An important aspect of the guidance is that federal agencies are instructed to apply 3% and 7% annual discount rates to future costs and benefits, including not just the time value of money, but also the time value of human life. That is, one must apply 3% and 7% discount rates to savings associated with avoided future deaths and nonfatal injuries. Using high discount rates reduces the apparent cost effectiveness of natural hazard mitigation compared with lower discount rates.

Since the *Report* is an independent assessment of the costs and benefits of natural hazard mitigation, it is important to consider other standard texts on BCA. Among the most highly cited texts on engineering economic analysis, Newnan (1983) recommended that engineers use the after-inflation cost of borrowing if an investment will be paid for with borrowed funds, as in most cases of new design and costly retrofit.

Zuang et al. (2007) offered a survey of discount rates for BCA, and showed that some agencies use discount rates less than 1% and others as high as 10%. Some are based on the cost of borrowing. Others considered the social rate of time preference (SRTP), that is, “the rate at which society is willing to

---

<sup>14</sup> See <https://www.fema.gov/benefit-cost-analysis> for more information.

postpone a marginal unit of current consumption in exchange for more future consumption.” Still others use the marginal social rate of return on private investment, also termed the marginal social opportunity cost of capital. See Appendix H for more discussion on discount rates, and how they are handled in the Interim Study.

### 3.10. METHODS TO QUANTIFY BUSINESS INTERRUPTION LOSSES

Disasters can cause costly BI losses. The inherent interdependencies across various sectors of the economy further exacerbate the direct effects of disruptive events, often resulting in significant ripple effects. A survey by Webb et al. (2000) indicated that the direct and indirect BI losses triggered by disasters can be as significant as the magnitude of the resulting physical infrastructure and property damages, and represent key contributors to disaster risk. McMahon and Friedman (2016) pointed to just-in-time inventory management systems as aggravating supply-chain losses. Notably, Allianz Global Corporate & Specialty (2015) asserted that BI losses to date account for a much higher percentage of the total loss than they did a decade ago. A more recent study by Varney (2016) further emphasized that BI losses have been ranked in the top spot of business risks four years in a row. In estimating BI losses, one must understand the magnitude and extent of linkages that exist across interdependent sectors of the affected regional economy.

Wassily Leontief was awarded a Nobel Prize in Economics in 1973 for what became known as the input-output (IO) model for the economy (Leontief, 1936). Miller and Blair (2009) provided a comprehensive introduction of the model and its applications. Leontief’s IO model described the equilibrium behavior of both regional and national economies (Isard, 1960). The IO model is a useful tool in economic decision-making processes used in many countries; it presents a framework that is capable of describing the interactive nature of transactions among economic systems. Extensions and current frontiers on IO analysis can be found in Dietzenbacher and Lahr (2004). It is worth noting that the traditional use of IO analysis for estimating the effects of economic shifts (e.g., changes in consumption) has been extended to other applications, such as disaster risk management, environmental impact analysis, and energy consumption, among many others. For example, IO analysis was used to estimate the economic impacts of the earthquake-induced disruption of lifelines in the conterminous United States (Applied Technology Council et al., 1991) and can be linked with the direct building occupancy losses that can be extracted from Hazus. (FEMA developed the Hazus software to estimate potential losses in disasters.<sup>15</sup>)

The IO model and an extension known as computable general equilibrium (CGE) analysis are two of the most popular methods typically used in evaluating the efficacy of resilience management to reduce BI and other economic losses in interdependent sectors. Rose (2009) provided detailed reviews of economic resilience definitions, categories, and enhancement strategies. Furthermore, innovations in disaster resilience policy and practical applications to workforce, infrastructure, and economic sectors have been

---

<sup>15</sup> See <https://www.fema.gov/hazus/> for more information.

developed by the New Zealand research and consulting group Resilient Organizations (2017). To complement rebuilding efforts in the aftermath of disasters, Finn et al. (2016) explored the concept of citizen-based planning and long-term resilience thinking as applied to communities hit by Hurricane Sandy. CGE analysis offers a more complex modeling framework for assessing the impacts of economic and disaster resilience policies (Rose and Liao 2005). It shares the capabilities of IO models in itemizing the effects of a disruptive event across interdependent sectors. In addition, CGE's explicit inclusion of prices and input substitution via elasticity parameters has the potential to more accurately describe the efficacy of strategies for allocating constrained resources, with the aim of minimizing BI and other economic losses. Nonetheless, the estimation of BI losses using IO modeling and data analysis are more practical, because CGE models are complex, expensive, and not readily available for small geographic areas. The U.S. Bureau of Economic Analysis (BEA) is the agency primarily responsible for releasing the official IO accounts for the United States at both national and regional levels.

Note that, in some cases, Hazus software cannot be used to estimate BI losses, e.g., for designing to exceed I-Code requirements for seismic design of new buildings. Chapter 4 presents a customized IO model to deal with such cases.

### 3.11. METHODS TO QUANTIFY SOCIAL IMPACTS

Though it has been more than a decade since the *2005 Mitigation Saves* study, little, if any, advancement in methodologies for quantifying societal benefits of hazard mitigation has occurred. In a 2014 review of studies focused on BCA, Shreve and Kelman (2014) reviewed 28 studies that assessed the benefits and costs of mitigation, highlighting both what was included in the analysis and the limitations of the study. Based on the data presented, few studies included societal benefits when analyzing the BCR. In the few studies in which BCR was included, avoided losses of life were primarily listed as the major societal benefit. The article noted a few exceptions that broaden the analysis to include health impacts and displacement. When specified, the authors of these studies almost always acknowledged omitting social benefits; most often because they were beyond the scope of the project.

The Interim Study aims, among other things, to include some broader social benefits beyond those included in the *2005 Mitigation Saves* study. One of the major limitations of including these types of costs is that they often require significant primary research that is beyond the scope of the project. However, some recent work by Sutley et al. (2016) led to the development of a methodology to include PTSD costs. This work analyzed data to determine a cost-benefit for earthquake structural mitigation in the City of Los Angeles, integrating a methodology for inclusion of PTSD costs. The method used in the Interim Study is modeled on the work by Sutley et al. (2016a, 2016b).

In the Interim Study, the project team used a review of the literature to set the rate of PTSD at each damage state to be the equivalent of a severe injury, that is, in Hazus' injury level 3. While the Hazus injury scale is problematic to map to abbreviated injury scale (AIS) categories, for consistency, the project team used the same mapping as the *2005 Mitigation Saves* study.

The project team determined the costs of PTSD based on the calculated PTSD rate and estimated costs for treatment, absenteeism, and cut back days. The team estimated the cost of treatment at \$5,400 per year based on a study on veterans conducted by the Congressional Budget Office (CBO, 2012). Jennings (2015) calculated costs of absenteeism and cut back days as a function of the annual number of work days lost (Kessler and Frank, 1997) and mean salary of the population.

The rate of PTSD also is probably affected by age, ethnicity, family structure, gender, income, and other factors that may be impractical to address in the Interim Study. See, for example, Jennings (2015) and Sutley et al. (2016).

It is important to note that Sutley focused only on earthquakes in the city of Los Angeles, and used socioeconomic data from the U.S. Census Bureau (USCB). However, a review of rates of PTSD after hurricanes (Perilla et al., 2002; Galea et al., 2008) and floods (McMillen et al., 2002; Norris et al., 2004) supported using the same rates across hazards. The project team modified this method for inclusion in the Interim Study, as discussed later.

### 3.12. METHODS TO QUANTIFY OTHER INTANGIBLES

The project team addressed other intangibles, such as environmental damage and loss of cultural value through damage to historical buildings, with benefit-estimate-transfer approaches. These vary by the type of benefit to be recognized: recreational water quality; drinking water; outdoor recreation trips; hazardous waste; wetlands; aesthetics; health and safety benefits from underground power lines; and cultural and historical resources. (See Appendix J of the *2005 Mitigation Saves* study for details.)

### 3.13. LAND USE PLANNING TO REDUCE FLOOD HAZARD

Flood risk can be reduced through land-use planning. Different land use types, such as green spaces and wetlands, can collect water and mitigate flooding. Conversely, development that is heavy on asphalt and concrete creates impervious surfaces, increasing runoff, flood velocity, and damage potential.

Infrastructure development can affect the height of flooding upstream or downstream. The NFIP does not allow development in floodways that would raise the BFE upstream or downstream by more than 1 foot (International Code Council 2014). Floodways are the channel of a river or other watercourse and the adjacent land areas that must be reserved in order to discharge the base flood without cumulatively increasing the water surface elevation more than a designated height. Because of the way the NFIP maps floodways, the NFIP allows new development in the SFHA (the 1% annual chance floodplain) to increase flooding by 1 foot. The I-Codes do not allow development to increase the BFE at all (International Code Council 2014).

The Association of State Floodplain Managers (ASFPM) advocates a policy of no adverse impact—development should not increase flood risk, increase costs, or lower water quality for other people or structures in the watershed (2016, 2003). ASFPM has many examples of flood mitigation management that can help a community satisfy the no-adverse-impact policy. These measures include removing or

## NATURAL HAZARD MITIGATION SAVES:

relocating structures from floodplains; preventing development in floodplains; zoning areas of land for particular uses such as agriculture and green space; preserving wetlands; improving water drainage and storage; using green infrastructure (e.g., parks and urban greenways) and materials; and reducing the coverage of impervious surfaces.

Integrated water resources management and its offshoot integrated flood mitigation (IFM) provide a framework for reducing flood damages while promoting economic, social, and ecological benefits. This is gaining favor over a gray-infrastructure strategy of relying on dams and levees to attempt to contain rivers and prevent flooding altogether (e.g., Santoto et al., 2013). While these structural measures may still be used, other measures are also available to distribute and absorb water flow while limiting the amount of infrastructure in the path of flood waters. IFM plans recognize that a river is a complex system, and all parts of it require consideration. Interactions between water, vegetation, and soils contribute to changes in stream velocity that can have impacts at points upstream or downstream.

Owners of properties that have sustained significant flood damage have the option to allow the government to acquire the property, also known as a buyout. FEMA works with state governments to finance this action. The owner receives the fair market value for the property. The property is demolished, permanently avoiding future damages and allowing the floodplain to absorb more water without damaging other structures.

Land use decisions are generally made at the state and local level. However, though land use planning and floodplain management are conducted by municipalities and states, floods are not restricted by political boundaries.

The NFIP's CRS provides incentives for a wide variety of mitigation measures. Communities can earn a reduction in flood insurance premiums by implementing these measures. Over 1,000 communities participate in the CRS. This is less than 10% of the communities in the NFIP, but nearly 70% of NFIP policies are in CRS communities. Florida and other parts of the southeastern United States have the highest participation in the CRS.

While the costs of property acquisition and demolition or relocation are high, future losses are completely avoided. Acquired land may be used for public spaces such as parks, creating additional co-benefits. FEMA has participated in the acquisition of several thousand properties over the past decade (Federal Emergency Management Agency 2017b, Association of State Floodplain Managers 2016). However, there are over 5 million properties that have NFIP policies (Federal Emergency Management Agency 2016a), so relocation and acquisition account for a small percentage of mitigation actions taken.

Nature-based solutions or green infrastructure offer some ability to adapt to changing flood risks. Green infrastructure also offers many benefits and opportunities for recreation, ecological services, and economic development (Kousky and Walls, 2014; Association of State Floodplain Managers 2003) over gray infrastructure, such as the use of tunnels and wastewater treatment plants to collect and discharge storm water. Gray infrastructure has both high initial costs of development and maintenance costs. It is inflexible

and could exacerbate flooding if its limits are exceeded. Green infrastructure is becoming more common in either replacing or complementing gray infrastructure, particularly in urban areas.

IFM strategies may require systemic changes to floodplain management and cause long-lasting socioeconomic changes in sectors such as housing, utilities, and transportation (Kundzewicz et al., 2010). Redesigning land use code practices for a community may be met with resistance, making communication even more important (Association of State Floodplain Managers 2016).

In one study, FEMA (Federal Emergency Management Agency 2013b) identified 10 success stories of integrating hazard mitigation into local planning. The examples were evenly distributed throughout the United States and included entire states and individual cities and counties. The actions taken in these case studies included improving and coordinating local plans, improving storm water drainage, adding sustainable infrastructure, and starting outreach programs. While the benefits of integrating land use planning can be substantial, each community has different characteristics and needs, and may choose to take different complex actions. Generalizing and quantifying the benefits of land use planning may not be possible.

The *2005 Mitigation Saves* study addressed the cost effectiveness of federal buyouts. The federal mitigation grants the project team studied for the Interim Study also focused on buyouts in order to establish comparable figures with the 2005 study and because, while considered a costly mitigation option, buyouts do provide the greatest societal benefit in the form of permanent avoidance of loss.

### 3.14. FLOOD RISK MODELING

Flood risk modeling refers to the process of estimating potential losses and damage for a particular asset at risk to a particular flooding event. Assets can include buildings, bridges, utility lines, farms, humans, animal stock, and others. A flood risk model can therefore be thought of as a product of the probability of hazards occurrence, nature of exposure, and the degree of vulnerability of the elements at risk (Rashed and Weeks, 2003). A community can be exposed to flood hazards but, if it has taken measures to lower its vulnerability, then it will not experience higher losses. Likewise, a highly vulnerable community will not experience any loss if does not actually experience flooding (Rashed, 2005).

A typical flood risk modeling procedure comprises the following tasks:

1. Generating a flood hazard scenario, and mapping the extent and intensity of flooding in a region based on hydrometeorological data and information about the terrain within the floodplain. The scenario can represent a historical occurrence of a flood in a region, or a statistical estimate of the probability of occurrence of a flooding event with a particular intensity in that region.
2. Creating an inventory of the nature and location of all “elements at risk” and assessing their vulnerability to flooding according to predefined assumptions about demographics, buildings, structures, and other vulnerable elements. The predefined assumptions are typically based on historical records that report the degree of damage that elements of the same kind have experienced

in the past as a result of flooding. For example, the vulnerability of a particular building type can be represented by an empirical damage curve created from recording different degrees of damage this type of building has experienced from different flooding events in the past.

3. Assessing the nature and degree of loss an element of risk may experience as a function of the flooding intensity, its vulnerability, and its exposure. The exposure is typically determined by its location within the floodplain and its level of inundation.

In mitigation studies, proper modeling of flood risks is crucial to the proper assessment of mitigation strategies. One common way to assess mitigation strategies is through the BCA of mitigation actions, where the benefit of an action is estimated in the form of the loss avoided from implementing that action. Avoided flood losses are typically estimated by running two scenarios of a flood risk model, one before the mitigation action is implemented, and one after its implementation. The difference in the losses generated from each scenario reflect the benefit gained from the implementation of the mitigation action.

BCA has been the principal decision-making technique for water resources planning since the enactment of the Flood Control Act of 1936. The primary reason for this is the fundamental framework of rational analysis that underpins the comparison of social benefits with social costs of various projects. Though BCA data are derived primarily from economic markets, innovations by analysts have enabled economic values to be derived for environmental and social amenities and services that were often overlooked in previous studies. For example, improvements in multiple-objective water resources planning and management pioneered in the late 1950s and early 1960s by the Harvard Water Program preceded the maturation of environmental economics as an academic discipline (see Eckstein 1958; Maass et al. 1962). Integration of new knowledge in the USACE *Principles and Guidelines*, which sets the criteria for BCA studies, has been fairly continuous (2013). In 2009, the USACE issued its guidance document for a national flood risk management program, and has fostered advances in integrated water resources management with environmental operating principles (U.S. Army Corps of Engineers 2012).

As a decision guide for human investment, BCA reveals the most economically efficient choices that provide the highest net social benefits to decision-makers. For planners tasked with the challenge of mitigating episodic flood hazards, BCA provides analysts with a detailed understanding of what specific elements of a mitigation plan or process improve the overall economic viability of any locality (e.g. Birchard et al., 2016). While many analysts have pointed out the shortcomings of BCA with respect to key intangibles such as the value of human life, the technique has provided decision-makers with a robust data-driven approach that is both reproducible and transparent. Similar to the lag time incurred in the modernization of building codes, there has been a comparable lag in efforts to keep BCA current with new knowledge and improved methods of decision-making. The findings of the Interim Study illustrate well the ability of BCA to incorporate a variety of factors deemed important to decision-makers, and enable them to make informed choices that are both socially desirable and economically appealing.

The *2005 Mitigation Saves* study used BCA of FEMA mitigation grants and eight community studies. The flood module of FEMA's Hazus software had not yet been fully developed, so other methods were



## NATURAL HAZARD MITIGATION SAVES:

necessary. The 2005 project team calculated BCRs of flood mitigation by identifying the locations of buildings affected, calculating the potential for hazards in that location, calculating the vulnerability (potential for damage) before and after mitigation, estimating the present value of losses under both conditions, and dividing the difference by the cost of mitigation.

The Interim Study uses Hazus software to conduct BCA of both above-code design and public-sector mitigation for riverine floods. The 2017 project team used the flood module of FEMA's Hazus release 3.2 software for the Interim Study. (Details of the Hazus loss estimation methodology for the flood hazard are described in the Hazus 2.1 Flood Technical Manual (Federal Emergency Management Agency 2006c) while key aspects of the model relevant to this project are described in the Interim Study.)

Hazus components include models for flood hazard, inventory, and damage and loss. Hazus allows users to apply default settings and databases for each of the inputs, but it also provides options for incorporating detailed data, if available, to reduce the margin of error and thereby expand the potential applicability of the model for a broader range of uses.

The building inventory models the location, characteristics, and property value of buildings in the Interim Study area. Except for selected building types such as schools and fire stations, the default Hazus building inventory, referred to as the GBS, aggregates to 2010 census blocks in the Hazus 3.2 flood model. The GBS inventory is compiled using a variety of data resources such as the 2010 census (to determine building count and distribution) and RSMeans (to estimate building replacement costs). Hazus categorizes the GBS into seven broad occupancy classes (e.g. residential, commercial, etc.) and 33 subclasses referred to as specific occupancies (e.g. single family, manufactured housing, etc.). Hazus has traditionally assumed that buildings in the GBS are evenly distributed throughout a census block, but recent releases now apply asymmetrically adjusted census block boundaries to better ensure that buildings are more likely to be placed in populated areas. That methodology uses 2011 satellite data to clip the census blocks to remove typically unpopulated areas such as forests, vacant land, and water bodies. For blocks that are intersected by the calculated flood hazard extent this should more accurately estimate the number of buildings damaged in those blocks. In general, this reduces estimated losses, particularly in rural areas.

The square footage of buildings in the default Hazus inventory is estimated using data on the heated floor area from the Energy Information Administration (EIA). The area is converted into income groups that vary by geographic region. Regional breakdowns of the percentage of buildings that have different occupancy types, number of stories, foundation types, age, and other characteristics are downscaled to estimate the number of buildings with those properties in each block.

The Hazus Comprehensive Database Management System allows users to supplement or entirely replace default inventory with information on specific buildings or to create more accurate aggregated data. One particularly useful component of the Hazus inventory is referred to as a user-defined facility (UDF). Hazus

## NATURAL HAZARD MITIGATION SAVES:

requires a UDF to have information on the foundation type, number of stories, first floor elevation, and occupancy class of the individual building.

Hazus uses depth-damage functions to associate the depth of water with the amount of damage a building sustains. The functions require information on building characteristics as well as the depth of flood waters. The main source of Hazus depth-damage functions (DDF) is the USACE. There are different groups of functions for different geographic regions. Each grid cell in the floodplain is assigned the appropriate flood depth and resulting damage value for the DDF. The number of cells for each flood depth in a census block is used to weight damage at that depth for each occupancy type. This approach means that results for individual census blocks may not be accurate, but high and low estimates tend to balance out if a larger area, such as a county, is considered. Users can edit the default functions or import functions from other sources. Hazus applies the same depth-damage functions to UDF, as it does for the GBS. This results in estimates for building loss amount, building damage percent, content loss amount, and inventory loss amount.

Hazus estimates losses in terms of both the cost of rebuilding and replacing buildings and other structures, as well as losses from disruption to the community, such as businesses being unable to operate. However, not all ripple effects of a disaster on the socioeconomic landscape can be represented. Estimates of direct physical damage to the GBS require building occupancy class, foundation type, first floor elevation, and flood depth. Hazus uses the DDFs to calculate a damage state for a census block as a percentage of the total building value damaged. The building states are separated into different percentage categories to aggregate estimates. Estimated building replacement costs are based on the building's size and occupancy class. The contents replacement value of a structure is assumed to be a percentage of the structure's replacement value, depending on the occupancy type. Business inventory values are calculated using the building's annual sales per square foot. The contents replacement value and building inventory value are multiplied by the appropriate depth-damage function to estimate losses.

Restoration time factors into many indirect loss calculations. Tables based on occupancy, flood depth, and location relative to the SFHA determine the restoration time in months. This includes the time to repair the building, remove debris, approve permits, and inspect buildings. If building damage is at least 50%, it is assumed that the building will be demolished and rebuilt (with modifications, if the building is in the SFHA). Relocation costs are disruption costs that building owners experience due to moving and renting temporary space, depending on the occupancy type. They are incurred when building damage is greater than 10%. Business proprietor losses, wage losses, and output (sales) losses are calculated using the amount of time to restore function, tables for building occupancy, the square footage of buildings, and income recapture. The number of days of employment lost is calculated by multiplying output loss by each industry's employment/output ratio. Rental income losses are calculated using the occupancy, square footage, damage state, rental cost, and recovery time.

Expected annualized loss (EAL), sometime called AAL, can be calculated by running Hazus for multiple flood probabilities and summing the product of the probabilities and damages caused. EAL can be

compared for scenarios with and without mitigation strategies, such as building elevation or removal, to evaluate the losses those strategies would avoid (Kousky and Walls 2014). In the FEMA Region IV losses-avoided study discussed in Section 3.5 (FEMA 2014e), it was estimated that losses avoided were underestimated by 10 to 20% because of missing data and data refinement. The assumption of perfect building code enforcement led to a 5 to 10% overestimate of losses avoided. It is possible to standardize estimates of enforcement based on CRS and BCEGS data. That study used lower-, average-, and upper-bound DDFs to obtain a range of loss estimates.

Hazus makes many assumptions in all aspects of its analysis, and these can contribute to a high degree of model uncertainty and sensitivity (Tate et al. 2015, Kousky and Walls 2014, Federal Emergency Management Agency 2006c). Hazus may be best utilized to estimate the magnitude of damage rather than make precise predictions (Kousky and Walls 2014). It does not output a measure of uncertainty for its flood hazard-related estimates. Hazus gives users the option to use default settings or provide more-detailed information for several analysis inputs. In general, one would expect that more-detailed user-defined data would produce more-accurate estimates. However, Tate et al. (2015) found that using a combination of default and more-detailed datasets can produce unstable results. Ideally, more detailed inputs would always be used, but this is not always possible or practical due to resource availability and computation time.

### 3.15. ESTIMATING FUTURE GROWTH

Some costs and benefits change over time as the population grows or moves. The Interim Study attempts to estimate costs and benefits decades into the future. As a baseline or minimum, one can project growth in new buildings by recognizing that new buildings are added on average at a rate of approximately 0.01 per year times the existing building stock (e.g., Ravetz, 2008). If a certain census tract has 100 buildings at the end of 2016, one can estimate that it will have on average 101 at the end of 2017, 102.01 at the end of 2018, and so on ( $101 \times 1.01 = 102.01$ ), or in general  $1.01^n$  times the original estimate at the end of  $n$  years. This simplistic approach does not account for population spread, e.g., people moving into previously unoccupied places, or growth in one place differing from the pattern of growth in another, but it is easy.

Using a more complex approach, the USCB offers state population projections through 2030 based on Census 2000 (USCB 2004). This approach offers the advantage of authoritativeness (USCB) and carries some disadvantages: (1) complexity: 50 state-level extrapolations rather than one simple mathematical rule; (2) somewhat detached from the value of exposed buildings: change in population is not the same as construction of new buildings; and (3) insufficient duration: the analysis requires extrapolating growth of the building stock for much more than 15 years.

### **3.16. ALTERNATIVES TO BCA FOR NATURAL HAZARD MITIGATION**

For a widely used textbook on engineering economics, see Park et al. (2007). Park and other common textbooks identify BCA as one of several approaches to quantify the desirability of an investment. One can also estimate ROI, in which one calculates the ratio of net benefits (the difference between benefits and cost) to total cost. It measures profitability. A higher ROI means a more profitable investment. It uses the same quantities as BCR. Or one can measure the desirability of an investment with an internal rate of return (IRR): the discount rate at which the present value of all future cash flow is equal to the initial investment or, in other words, the rate at which an investment breaks even. One can measure the desirability of an investment with its expected value of utility, a somewhat abstract measure of satisfaction, preference, or happiness, usually of an individual, that underpins game theory and Stanford-style decision analysis.

## 4. Methodology Employed in This Study

### 4.1. ENGINEERING APPROACH TO BCA

As done in the 2005 Mitigation Saves study, the project team for the Interim Study used an engineering approach to estimate BCR. Figure 4-1 and the process below summarize the steps of an “engineering approach.”

1. **Exposure data.** Acquire available data about the assets exposed to loss. Often these data come in formats intended for uses other than those to which the analyst intends to put them.
2. **Asset analysis.** Interpret the exposure data to estimate the engineering attributes of the assets exposed to loss. These attributes (denoted by  $A$ ) may include quantity (e.g., square footage), value (e.g., replacement cost), and other engineering characteristics (e.g., model building type) exposed to loss in one or more small geographic areas. Occasionally assets are described probabilistically (e.g., the probability  $P$  that each asset has some set of attributes  $A$ , given the exposure data  $D$ , denoted by  $P[A|D]$ ). Combine the data  $D$  and the asset model  $P[A|D]$  to estimate the probability that the assets actually have attributes  $A$ , denoted by  $P[A]$ .
3. **Hazard analysis.** Select one or more measures of environmental excitation  $H$  to which the assets are assumed sensitive (e.g., peak wind gust velocity at 33 ft elevation in exposure category  $C$ ), and estimate the relationship between the severity of those measures and the frequency (events per unit time) with which each of many levels of excitation is exceeded. The relationship is denoted as  $P[H|A]$ , (e.g., the probability that the environmental excitation will take on value  $H$ , given attributes  $A$ ). Combines  $P[A]$  and  $P[H|A]$  to estimate the probability of various levels of excitation, denoted by  $P[H]$ .
4. **Loss analysis.** Select loss measures to quantify, for example, property repair costs, casualties, duration of loss of function, etc. For each taxonomic group in the asset analysis, estimate the relationship between the measure of environmental excitation  $H$  and each loss measure  $L$ . This relationship is called the vulnerability model, denoted by  $P[L|H]$ . Loss measures are usually expressed at least in terms of expected value, and often in terms of the probability distribution of loss conditioned on (e.g., given a particular level of) environmental excitation. Use the theorem of total probability to estimate either the expected value of loss or the probability of exceeding one or more levels of loss, for each loss measure. Sometimes one estimates and separately reports various contributors to loss by asset class, by geographic area, by loss category, etc. One combines  $P[H]$  and  $P[L|H]$  to estimate the probability of various level of loss, denoted by  $P[L]$ .
5. **Decision-making.** The results of the loss analysis are almost always used to inform some risk-management decision. Such decisions always involve choosing between two or more alternative

## NATURAL HAZARD MITIGATION SAVES:

actions, and often require the analyst to repeat the analysis under the different conditions of each alternative, such as as-is and assuming some strengthening occurs.

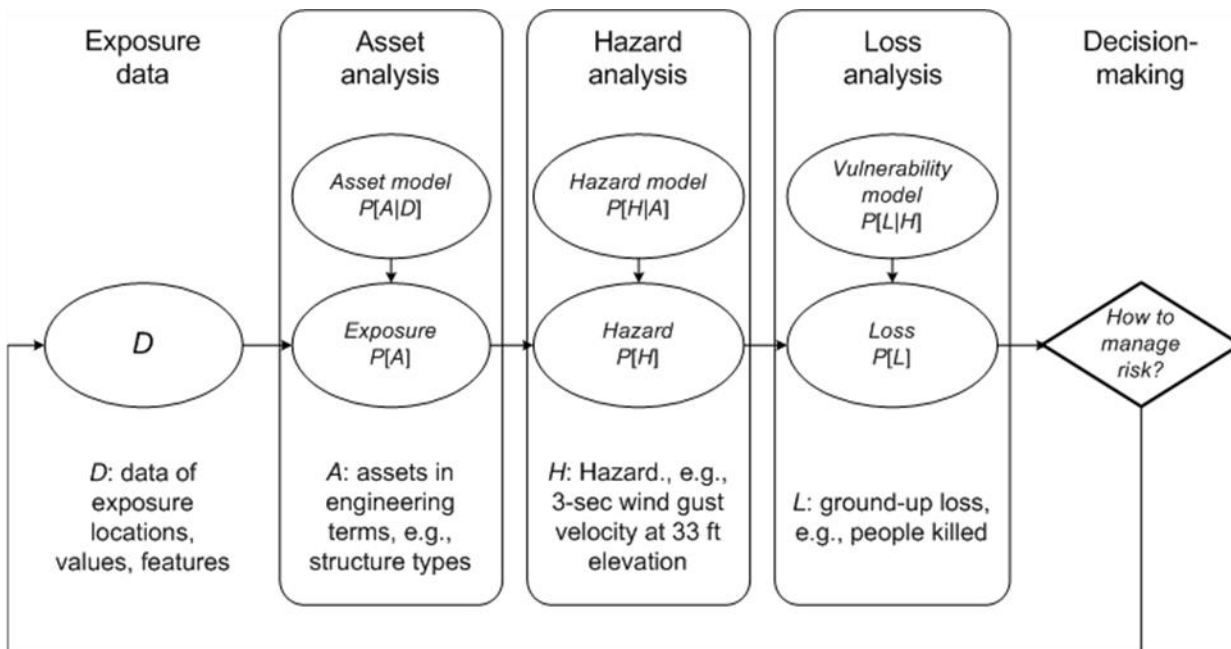

Figure 4-1: An engineering approach to risk analysis (image credit: Porter 2017, used with permission).

## 4.2. BCA FOR MITIGATION ESTIMATES LONG-TERM AVERAGES

This project quantifies the desirability of natural hazard mitigation using BCRs, meaning the ratio of the present value of reduced future losses (the benefit) to the added construction cost or retrofit cost of those mitigation efforts (the cost). The benefits average over time, considering large and small disasters that may occur at any point in time during the economic life of the mitigation measure, and considering the likelihood that these events will happen at all.

The more likely a disaster is to occur, or the more severe its outcomes, the greater the expected value of the benefit that mitigation will produce. In the case of a mitigation measure that applies to many buildings, the more buildings that are likely to be affected by a disaster during their economic life, the greater the calculated benefit, because the benefit represents an average over all the mitigated buildings.

As a consequence of this averaging process, BCA has an important limitation when applied to natural hazard mitigation: a BCR by itself tells the decision-maker nothing about the chance that the mitigation measure will actually be needed during the economic life of a building. The rarer the disaster, the less likely that a mitigation measure will actually produce value by reducing loss. While the BCR accounts for that likelihood through the averaging process, some decision-makers may object to the fact that money is

definitely being spent up front to reduce a loss that may never occur to their building, and that the benefit of mitigation may only be enjoyed by somebody else, or by nobody at all.

### 4.3. CALCULATING AGGREGATE BENEFIT-COST RATIO

This project aims ultimately to estimate the aggregate nationwide BCR for a suite of natural hazard mitigation measures, along with BCRs for subsets of mitigation efforts, such as by peril. Once a sufficient number of mitigation strategies and their BCRs are studied, the project team will calculate the aggregate BCR for public- and private-sector investment in mitigation by aggregating results from each strategy.<sup>16</sup> In the case of the *2005 Mitigation Saves* study, the overall BCR of 4.0 was calculated based on a sample of particular mitigation measures. The sample was scaled up to estimate the benefit of all FEMA-funded mitigation from 1993 to 2003. The same scaling-up procedure is used here. Equation 4-1 through Equation 4-7 show how that scaling works. The equations can be explained as a four-step process:

**Step 1.** Select a sample mitigation effort. Calculate its expected (e.g., average) annualized loss (EAL) due to natural disasters in the absence of mitigation strategy  $i$ , as shown in Equation 4-1. In the equation,  $\lambda(x)$  denotes the mean exceedance rate of environmental excitation  $x$  (for example, wind speed) to a sample facility;  $y(x)$  denotes the mean loss to the sample facility (as a fraction of replacement value) when subjected to excitation  $x$  absent mitigation strategy  $i$ ; and  $V$  denotes the value exposed to loss, absent the mitigation strategy. Note that the vulnerability function  $y(x)$  represents more than property loss. It also comprises time-element losses, losses associated with deaths and nonfatal injuries, loss of employment, and may include a variety of financial, social, and cultural losses. Then repeat this calculation for the same facility but under remediated conditions, that is, with a mitigation strategy applied. That is, calculate  $EAL'$  (what-if-mitigated EAL) using a what-if-mitigated vulnerability function  $y'(x)$ , using the same Equation 4-1.

Note that some mitigation measures can produce benefits for several different perils, such as engineered tie-down systems. Equation 4-1 would be applied separately for each peril and then summed to estimate  $EAL$  and  $EAL'$  from each relevant peril. Note also that some perils change over time: for example, a recent model of California seismic hazard accounts for estimated time dependency (Field et al. 2015). SLR changes the coastal flooding hazard and tsunami hazard.

In some situations, Equation 4-1 involves integration over time. That is,  $V$ ,  $G$ , and perhaps  $y$  may also be functions of time, so the equation more properly has a second integral over time. The second integral is omitted from the equation for clarity, but this work attempts wherever practical to quantify the three variables as functions of time and carry out the second integral. For example, where dealing with the costs and benefits of designing new buildings to exceed I-Code minima, the project team recognized that the quantity of buildings (an aspect of  $V$ ) grows approximately exponentially. Coastal

---

<sup>16</sup> Given the limited number of mitigation strategies covered in the Interim Study, the project team decided not to provide an aggregate BCR at this time to avoid future confusion.

flooding hazard ( $G$ ) will change with local sea level (LSL) rise, which may vary nonlinearly with time. This aspect may generate controversy and criticism, so the project team attempted to use the best practical science and engineering to model how exposure and hazard will change over time in the future. The Interim Study documents reasonable alternatives and explains choices later in the work. (Nonstationary vulnerability is more dubious than time-varying exposure and hazard. The temporal changes of material strength and stiffness observed in the laboratory, such as with concrete cylinder strength, are small compared with uncertainty in vulnerability. The analysis generally assumes therefore that engineering vulnerability  $y$  remains constant over time.)

**Step 2.** Calculate the benefits for an individual mitigation strategy (denoted by  $b_i$ ) over time  $t$ , as shown in Equation 4-2. In that equation,  $EAL$  and  $EAL'$  represent the expected annualized disaster losses to a sample facility before and after applying mitigation strategy  $i$ . The term  $r$  denotes the after-inflation annual discount rate (which measures the time value of money), and  $t$  denotes the number of years that mitigation strategy  $i$  is effective. Multiply  $b_i$  by the ratio of nationwide expenditures to the expenditures represented by the sample ( $E_i$  and  $e_i$  respectively), as shown in Equation 4-3. The product is the nationwide benefit of strategy  $i$  (denoted by  $B_i$ ). Note that Equation 4-2 accounts for the possibility that the mitigation measure is never actually used—that the peril does not occur during the effective life of the mitigation measure. It says that benefits do not accrue after time  $t$ .

**Step 3.** Sum over all mitigation strategies ( $i = 1$  to  $n$ ) for a first-order estimate of the nationwide aggregate benefit of all the strategies considered, as shown in Equation 4-4. Add the *synergy benefit*, that is, the benefit that accrues because of interaction between two or more mitigation strategies: strategies  $i$  and  $j$  in the double summation in Equation 4-4, or strategies  $i, j$ , and  $k$  in a triple summation. For example, a facility that was built stronger, with ongoing nonstructural mitigation, and uses an up-to-date business continuity plan, is likely to resume business more quickly than one where only one or two of those measures have been implemented. The term  $m$  in Equation 4-4 represents a multiple reflecting the fractional increase in benefit that accrues because of synergies between mitigation measures.

**Step 4.** Calculate the aggregate and per-strategy BCRs. The aggregate nationwide cost is calculated similarly to the first-order benefit, as in Equation 4-5. The ratio of the aggregate nationwide benefit to the aggregate nationwide cost is the aggregate nationwide BC, as in Equation 4-6. The Interim Study also includes an estimate of BCRs for individual mitigation strategies, as shown in Equation 4-7.

$$EAL = V \int_0^{\infty} -\frac{dG(x)}{dx} y(x) dx$$

Equation 4-1



## NATURAL HAZARD MITIGATION SAVES:

$$b_i = \frac{EAL - EAL'}{r} (1 - \exp(-rt))$$

Equation 4-2

$$B_i = \frac{E_i}{e_i} b_i$$

Equation 4-3

$$B = \sum_{i=1}^n B_i + \sum_{i=1}^n \sum_{j>i}^n m_{i,j} (B_i + B_j) + \sum_{i=1}^n \sum_{j>i}^n \sum_{k>j}^n m_{i,j,k} (B_i + B_j + B_k) + \dots$$

Equation 4-4

$$C = \sum_{i=1}^n \frac{E_i}{e_i} \cdot c_i$$

Equation 4-5

$$BCR = \frac{B}{C}$$

Equation 4-6

$$bcr_i = \frac{b_i}{c_i}$$

Equation 4-7

In the case of values that change over time and accumulate over a geographic area, such as codes in which effects change with population, Equation 4-1 can be recast by summing over area  $A$  and integrating over time  $t$ , as in:

$$EAL = \sum_A \left( V_0 \left( \int_{x=0}^{\infty} -\frac{dG(x)}{dx} y(x) dx \right) + \int_{t=0}^T \frac{dV}{dt} \left( \int_{x=0}^{\infty} -\frac{dG(x)}{dx} y(x) dx \right) dt \right)$$

Equation 4-8

The ultimate goal is to estimate whether or not natural hazard mitigation is cost effective, but it is only practical to calculate BCR for a sample of projects. What can one say about the true, population-wide BCR based on the sample? Sums of many uncertain numbers tend to take on a particular probability distribution—the familiar bell-shaped curve of the normal distribution. The true population-level BCR is related to the sample-average BCR through a quantity called the standard error, which is calculated using Equation 4-9. One can use that standard error to estimate the probability that mitigation is actually cost effective (e.g., that the population-level BCR exceeds 1.0) using Equation 4-10. That is, Equation 4-10 estimates the chance that, if one were able to perform a BCA of every mitigation effort and add up all their costs and benefits, benefits would exceed costs. The equation assumes that the sample is unbiased; that is, on average, if one were to select many different samples, the average of their BCRs would equal the population-level BCR. The *2005 Mitigation Saves* study found a grant-sampling strategy that is indeed unbiased, which will be further discussed in Section 4.9.

$$s = \frac{1}{n} \times \sqrt{\sum_{i=1}^n (bcr_i - \overline{bcr})^2}$$

Equation 4-9

$$P[BCR > 1] = 1 - \Phi \left( \frac{1 - \overline{bcr}}{s} \right)$$

Equation 4-10

In Equation 4-10,  $P[ ]$  denotes the probability that the statement inside the square brackets is true,  $\Phi$  denotes the standard normal cumulative distribution function, and  $\overline{bcr}$  denotes the sample average BCR, calculated as shown in Equation 4-11.

$$\overline{bcr} = \frac{1}{n} \sum_{i=1}^n bcr_i$$

Equation 4-11

## 4.4. SELECTION OF DESIGNS TO REFLECT BELOW-CODE PRACTICE

### 4.4.1. Below-Code Designs for Wind

The differences between below-code designs for hurricane wind and the 2018 I-Codes are due to both the change in wind hazards identified in ASCE 7-16 and the prescriptive and performance-based requirements set forth by the IBC/IRC. As identified in Section 3.3.1, roof design pressure requirements increased significantly when comparing pre-Hurricane Andrew construction to 2018 I-Codes.

The project team used the calculated roof design pressures to choose the Hazus parameters most representative of the typical construction at the time. The current Hazus technical manual identifies the component resistance values of each mitigation option utilized in their damage functions. For example, for single-family residential structures, the roof sheathing with 6d nails, spaced at 6"/12" is assumed to have a mean uplift resistance of 61 psf. For the models considered in the analysis with plywood sheathing, the mitigation option is chosen where capacity values are greater than the design pressure requirements. In some cases, the prescriptive requirements of the IRC will override; therefore that mitigation option is chosen. This scenario is repeated for each mitigation option of four model building types.

For this study, three low-rise commercial structures (a retail strip mall with open web steel joists, a retail strip mall with a wood roof diaphragm, and a hotel/motel with a wood diaphragm) and a single-family residential structure (single-story, wood-framed) were chosen to represent typical commercial and residential construction in the areas of interest (the Gulf and Atlantic Coasts).

### 4.4.2. Below-Code Designs for Flood

The primary differentiator between the baseline/below-code buildings and the I-Code compliant buildings is the elevation of the lowest floor. For riverine locations, the I-Codes do not provide any significant changes to the NFIP that could be reasonably modeled. In coastal areas, the I-Codes utilize the Coastal A Zone, for which IBC incorporates higher requirements since the 2006 version of the I-Codes and for IRC buildings has been recognized since 2015.

Since the majority of buildings are designated as Risk Category II, the Interim Study focused on common commercial use buildings and single-family residential buildings to represent savings for the built environment. Building types evaluated were:

- Office building (business), 1-story (2,000, 7,000, and 25,000 square feet): (a) vinyl clapboard over wood frame, (b) stone veneer over wood frame, (c) fiber cement over rigid steel, (d) EIFS over rigid steel, (e) precast concrete over reinforced concrete, and (f) brick veneer over reinforced concrete
- Office building (business), 3 stories (5,000, 16,000, and 80,000 square feet): (a) vinyl clapboard over wood frame, (b) stone veneer over wood frame, (c) fiber cement over rigid steel, (d) EIFS over rigid steel, (e) precast concrete over reinforced concrete, and (f) brick veneer over reinforced concrete

## NATURAL HAZARD MITIGATION SAVES:

- Retail store (4,000, 10,000, and 22,000 square feet): (a) vinyl clapboard over wood frame, (b) fiber cement over wood frame, (c) EIFS and metal studs over steel joists, (d) stone veneer over rigid steel, (e) brick veneer over reinforced concrete, (f) stucco over reinforced concrete
- Warehouse (10,000, 30,000, and 60,000 square feet): (a) metal panel rigid steel, (b) pre-engineered metal building rigid steel, (c) EIFS over rigid steel, (c) brick veneer reinforced concrete, (d) precast concrete reinforced concrete, (e) tilt-up concrete panels
- One-story house (1,500 and 3,000 square feet): (a) wood siding - wood frame, (b) brick veneer - wood frame, (c) stucco on wood frame, (d) solid masonry
- Two-story house (2,400 and 4,800 square feet): (a) wood siding - wood frame, (b) brick veneer - wood frame, (c) stucco on wood frame, (d) solid masonry

Commercial buildings often are not constructed with basements since this would require them to be dry floodproofed. In the Interim Study, commercial buildings are assumed to have slab-on-grade foundations with a stemwall perimeter wall. Any mechanical, electrical, or plumbing system that was located below the slab would have been protected by the stemwall and fill from flood damage. This means that for each building the primary exposure was when flood elevations met or exceeded the lowest floor elevation.

Residential buildings were evaluated in a similar manner to the commercial buildings. Note that the size of the single-family residential buildings matched the first phase of this project for consistency. The foundation systems for the residential buildings were a mixture of stemwall foundations with a slab-on-grade over the enclosed fill material and crawlspace foundations using masonry block with interior masonry piers. Since the NFIP requires that all materials below the lowest floor be flood damage-resistant materials, the project team assumed that any flooding damage below the lowest floor elevation was minimal. Since approximately 18 different variations in floodplain cross section were evaluated, foundations were applied based on the cross slope of the floodplain. In shallow floodplains where the difference in the 10-year flood and 100-year flood were less than 3 feet, the project team assumed that homes would be constructed on stemwall foundations. When the floodplain slope resulted in the difference between the 10-year flood and 100-year flood was between 3 feet and 5.5 feet, a 50-50 split was applied to stemwall foundations and crawlspace foundations. Floodplains where the difference in the 10-year and 100-year flood exceeded 5.5 feet used only crawlspace foundation. This assumption was used to reflect that in steeper cross-section floodplains it was more cost-effective to use a crawlspace and to avoid the cost of fill placement, even in foundations compliant to the BFE.

### 4.4.3. Below-Code Designs for Earthquake

Seismic design procedures have appeared in model building codes since the 1927 edition of the UBC. They have grown in length and complexity, in several general ways:

1. By accounting for regional seismicity through the use of zone maps.
2. By accounting for local differences in seismicity first through the introduction of near-source terms and then through seismic microzonation, via several iterations of maps of rare shaking, maps

produced the U.S. Geological Survey (USGS) National Seismic Hazard Mapping Program (NSHMP) and its predecessors.

3. By accounting for resonance of the building with earthquake ground motion, first through number of stories, and later via height and lateral force resisting system.
4. By accounting for the ductility capacity of the building's lateral force resisting system, with a gradually expanding list of systems, each with its own estimate of ductility capacity.
5. By accounting for the societal importance of a building through an earthquake importance factor  $I_e$ , later denoted  $I_e$ .
6. By accounting for the amplification of ground motion associated with lower shear wave velocity in surficial soil versus rock.
7. By changing from ASD to load and resistance factor design.
8. By changing from no explicit reliability goal, to one of low probability of life-threatening damage under shaking with a factor of 2,500-year shaking (as expressed in the reliability index underlying seismic design using load and resistance factor design), to low probability of collapse during the building's design life (as proposed by Luco et al. 2007).
9. By controlling displacement, again using a parameter that depends on lateral force resisting system.

As detailed in Appendix M, one can quantify a long-term average trend of increasing strength of approximately 4% per 3-year code cycle, or 50% per 30 years. In the approximately 40 years during which the UBC and IBC limited deflection, they generally increased the design base shear. While the base shear increased, allowable deflection did not. Since stiffness is commonly defined as force (here, design base shear) per unit of displacement (here, allowable deflection), the increase in strength has required a proportional increase in stiffness.

Below-code designs are therefore taken here as buildings just like those constructed to comply with the 2018 I-Codes, but to reflect design to strength and stiffness requirements approximately like 30, 60, and 90 years ago. That is, with current values divided by 1.5,  $1.5^2$ , and  $1.5^3$ , or equivalently, multiplied by 0.67, 0.44, and 0.30, respectively. See Appendix K for details.

### 4.5. SELECTION OF DESIGNS TO EXCEED 2015 I-CODE REQUIREMENTS

The previous section covered the calculation of BCRs *for ex post* mitigation, e.g., mitigation after a building is built (often called retrofit or remediation). This section examines *ex ante* mitigation, that is, mitigation prior to the event, in this case, constructing new buildings to exceed the current local minimum requirements. The math is largely the same.

Specifically, estimate the benefits and costs that would result from designing buildings to exceed I-Code requirements using the methods described in Section 4.1. For all perils except fire at the WUI, the project team estimated the costs and benefits of exceeding I-Code requirements relative to I-Codes published by October 2016. For simplicity, the team considered only the ordinary buildings—Risk Category II buildings

under ASCE 7-10. The project team then estimated EAL in all the categories listed in Chapter 0. To select design options, the project team weighed the advantages and disadvantages of options discussed in Section 3.2 and selected those shown in Table 4-1 for analysis.

**Table 4-1:** Selected mitigation strategies for exceeding I-Code requirements.

Peril	Selected design option	Rationale
Flood and storm surge	Increase elevation beyond the 1 foot required above BFE.	Straightforward to implement both in calculations here and in practice. All designers possess the necessary skills.
Earthquake	Increase ASCE 7-10 strength and stiffness requirements by a factor $I_e$ .	Straightforward to implement both in calculations here and in practice. All designers possess the necessary skills. Growing support within the earthquake engineering community and a few informed building owners. Relevant to perhaps 82% of new buildings in seismic-prone areas that have adopted disaster-resistant building codes. Addresses both structural and much (though not all) nonstructural damage.
Hurricane wind	IBHS FORTIFIED Home and Commercial Hurricane program.	Straightforward to implement both in calculations here and in practice. Well documented. Growing support and implementation within hurricane-prone regions.
Fire	Adopt ICC 2015 IWUIC	Strong support from the ICC. Well documented. Straightforward to implement. Readily calculated.

## 4.6. SELECTION AND ANALYSIS OF PRIVATE-SECTOR RETROFIT MEASURES

### 4.6.1. Selection and Analysis of Flood Retrofit of Single-Family Dwellings

#### 4.6.1.1. Benefit Categories Considered for Flood Retrofit

Table 4-2 summarizes the benefit categories that seem to result from each retrofit option considered here. More information on the benefit categories is provided in Section 5.5.

**Table 4-2:** Benefit categories associated with each flood retrofit option

Mitigation Option	Building damage	Contents damage	Additional living expenses	Indirect bus. interruption	Post-traumatic stress disorder	Death and nonfatal injury	Insurance overhead and profit	Green space
Acquisition	✓	✓	✓	✓	✓	✓	✓	✓
Retrofit elevation	✓	✓	✓	✓	✓		✓	
Wet floodproof basement	✓							
Elevate air conditioning and heat pump; relocate ducts	✓							
Relocate furnace and water heater	✓							
✓ - Indicates a category of benefits or avoided damage considered for the mitigation option								

The project team was unable to quantify some important hazard and benefit issues. At some point, flood hazard may change because of future development, changes in flood protection, and changes in precipitation rates, but it was impractical to consider these issues here. Households’ socioeconomic status affects their ability to recover from flooding, but the project team could not quantify that effect in such a general study. As with other mitigation measures considered here, flood retrofit can provide a number of intangible benefits such as peace of mind and protection of heirlooms and pets, but the project team was unable to estimate the monetary value of these benefits.

Flood mitigation differs from seismic and hurricane wind mitigation in that the flood risk quickly varies in space, over tens or hundreds of feet horizontally and a few feet vertically. By contrast, wind and seismic risk are more regional in nature. Therefore, retrofit options, including the acquisition (also called buy out) of a property, were selected based on factors of commonality of the measure and the ability to model the risk reduction achieved by its implementation. The study focused on mitigating single-family houses, which represent a large portion of the private-sector buildings vulnerable to flood risk and which receive a significant amount of government grant funding. Additionally, the study primarily addresses riverine flood risk with no focus on coastal flood risk. The applicability of these measures in areas subject to coastal

## NATURAL HAZARD MITIGATION SAVES:

flooding is dependent upon the consideration of flood conditions, such as waves of higher velocity storm surge. Some measures, such as wet floodproofing of basement areas, may be less applicable than filling of basement areas due to the risk of collapse during storm surge. This study evaluated flood risk based on inundation flooding and, as indicated in Section 5.5, does not address velocity flows.

The primary mitigation measures studied were acquisition of flood-prone properties, retrofit-elevation of properties, wet floodproofing of basement areas, and utility retrofits. Retrofits present some regulatory challenges within floodplains. All buildings within the Special Flood Hazard Area (SFHA) are subject to substantial-improvement requirements. FEMA defines substantial improvement as “any reconstruction, rehabilitation, addition, or other improvement of a structure, the cost of which equals or exceeds 50 percent of the market value of the structure before the start of construction of the improvement. This term includes structures that have incurred substantial damage, regardless of the actual repair work performed.” (<https://www.fema.gov/floodplain-management-old/substantial-improvement>) If the cost of the retrofits meet or exceed the substantial-improvement threshold, the building would need to comply with the current locally-adopted floodplain management requirements, which must equal or exceed the NFIP minimum requirements. Basically, if the consideration of a costly retrofit means that a residential building would be substantially improved, the owner then would need to elevate the building to comply with NFIP requirements. It was therefore only appropriate to consider either acquisition, retrofit elevation, or low cost retrofit options. This study did not consider retrofit options that would either violate the NFIP minimum requirements or potentially increase the safety risk to occupants.

Additionally, this study did not consider other retrofit measures such as dry floodproofing, berms, and ring levees as none of these measures can be used to bring a non-compliant building into compliance with current floodplain management requirements. Dry floodproofing, which also could include the use of emergency house wraps or sandbags, was considered too risky in many instances since many of these approaches depend on wall systems as one of the structural components. Wall systems would need to be carefully evaluated for strength and could require costly retrofits to be considered sufficient to resist flood loads. Under high flood conditions, these systems could either put occupants at risk or result in significant structural damage to the building. These measures also are subject to overtopping, meaning that the mitigation measure is nullified once floodwaters exceed the flood protection elevation. These measures may be applied on a small scale for nuisance flooding in areas outside the SFHA, but the focus of the study was to address the risk to buildings that are within the SFHA and have the lowest floor or components currently below the BFE.

### Allowable Residential Dry Floodproofing

Although, it could be noted some communities within the NFIP allow the dry floodproofing of residential buildings, it must be pointed out that this represents approximately 54 communities that have received exemptions from FEMA out of over 20,000 total NFIP communities (*FEMA 2018*). This suggests that where dry floodproofing is allowable for residential properties, it is not a statistically significant percentage for a national study.



### 4.6.1.2. Selection and Analysis of the Building Types for Flood Retrofit

Buildings analyzed in this study represented both one- and two-story single-family dwellings using common construction approaches.

- One-story house (1,500 square feet and 3,000 square feet): (a) wood siding - wood frame, (b) brick veneer - wood frame, (c) stucco on wood frame, (d) solid masonry
- Two-story house (2,400 square feet and 4,800 square feet): (a) wood siding - wood frame, (b) brick veneer - wood frame, (c) stucco on wood frame, (d) solid masonry

The use of the square foot sizes of houses and construction types were consistent with the approach used in previous interim studies within this report. However, it should be noted that according to the U.S. Census Bureau data, the average year-round house size is approximately 1,500 sf, while the average owner-occupied house is approximately 1,800 sf. Therefore, though newer houses are larger than older ones, the flood retrofit analysis should focus on older houses constructed prior to an area being mapped in the SFHA. The project team assumes, once an area is mapped, that the majority of houses will be constructed to a compliant elevation and will have a significantly lower flood risk than existing houses.

The project team evaluated house foundations as both slab-on-grade buildings, where the lowest floor is the top of the floor slab, and crawlspace and basement foundations. For some mitigation measures, only the evaluation of crawlspace and basement foundations mattered as the flood retrofits only applied to houses with basements or crawlspaces.

The project team additionally used lowest floor elevations as a key elevation reference point for the majority of the flood retrofit measures. For acquisition and retrofit elevation the lowest floor became a reference for the depth-damage function (see Section 5.5) and as a reference point from which to associate a depth-damage function for other retrofit measures. The analysis evaluated buildings with a lowest floor a BFE-1 through BFE-4 for all flood retrofit options, but also included BFE-5 through BFE-8 for acquisition projects.

Similar to the study conducted on the value of buildings meeting the 2018 IBC and IRC, this study used hypothetical floodplains based on numbered A Zone data and therefore discusses mitigation projects based on their lowest floor relationship to BFE rather than specific geographic areas. See Section 5.5 for more information.

### 4.6.1.3. Selection and Analysis of the Acquisition of Single-Family Dwellings

The acquisition of flood-prone properties represents the most effective flood mitigation option. This approach removes the potential for a property to experience flood damage in perpetuity and assumes that the community permanently will avoid using the land in ways that would result in flood damage. Such mitigation often exists in direct comparison with retrofit elevation when communities are looking for more permanent flood protection measures. Acquisition or “buyout” means a property owner would financially be compensated for the fair market value of the property and relocate to another property – ideally

outside the SFHA. The costs associated with property buyout include not only the value of the single-family house, but also the lot and any improvements to it, thereby usually making it more costly than a retrofit elevation. By comparison, the acquisition and subsequent demolition of the property means that there will be no flood damages to it. Retrofit elevations still have residual risk since the house is still subject to flooding and can experience significant damage once the flood elevation exceeds the elevated lowest floor (BFE +1 for this study). Although there is a significantly lower probability of this occurring, it still represents residual risk.

The evaluation of all types of single-family dwellings covered potential flood damage from BFE-1 to BFE-8.

The cost to acquire the property was not adjusted based on the risk of flooding because data on reduced property values for buildings subject to flooding did not appear to sufficiently be stratified to accommodate values on the reduced value per foot below the BFE. Costs, based on third quarter data from the Federal Housing Finance Agency (FHFA) dated October 2018, also considered U.S. national data as well as the FHFA New Release dated January 23, 2019.

Readers should consider that, although this study evaluates the cost effectiveness of acquiring single-family houses, an effective overall mitigation strategy also should take into account similar benefits for acquiring various types of properties. Manufactured homes, townhouses, and apartment buildings are other types of residential properties that may be viable acquisition projects. In fact, acquisition could solve many problems arising from trying to retrofit apartments and townhomes as elevation could be difficult and dry floodproofing is not a viable option for residential properties. Elevation as an option for manufactured homes depends on the location as it could result in increased risk of wind or seismic damage.

### Comparing Acquisition with Retrofit Elevation

Readers should note that acquisition was not an initial mitigation measure scoped for the study and it was added at the request of the Association of State Floodplain Managers (ASFPM). Due to the approach used to calculate BCAs for acquisition, this was not a significant change in scope. Retrofit elevation scopes to be studied from BFE-1 to BFE-4 since considering the additional height would require significant modifications to the cost-estimating approach to reflect the necessary changes to foundation elements, including block thickness, additional reinforcing, and changes in footing. Readers should consider the differences in the initial lowest floor elevations considered when comparing acquisition to retrofit elevation. Study of the cost effectiveness of retrofit elevation for houses with a lowest floor below BFE-4 is a topic being considered for future study.

#### 4.6.1.4. Selection and Analysis of Retrofit Elevation of Single-Family Dwellings

The team evaluated retrofit elevation projects in two primary categories, slab-on-grade and crawlspace foundations, to appropriately designate the cost of elevation. For cost purposes, the assumption stands that houses would be elevated from an existing condition of BFE-1 through BFE-4 up to an elevation of BFE+1, that is, base flood elevation plus 1 foot of freeboard. Post-retrofit elevation was based on the requirements for the lowest floor to be in a post-mitigation minimum elevation that matches the requirements of the 2015-or-later International Residential Code and ASCE 24. A significant number of

## NATURAL HAZARD MITIGATION SAVES:

grants from FEMA and HUD would require a minimum elevation meeting either the code/engineering standard minimum elevation or the local floodplain ordinance, whichever is higher. To calculate a national value for the reduced flood damages associated with retrofit elevation, this approach represents an assumed common final elevation for the lowest floor. While it is possible for some retrofit elevation projects to exceed BFE+1, others may be allowed to use BFE depending on the funding source. All elements below the lowest floor have been assumed to be compliant with the use of flood damage-resistant materials and an appropriate number of flood openings.

Additionally, the team assumed that homes with a crawlspace were constructed on wood-framed floor systems with either a concrete masonry unit (CMU) block perimeter wall or a poured concrete perimeter wall foundation. The retrofit elevations utilize a series of steel-lifting beams and a series of synchronized lifting jacks to elevate the house. After the extension of jacks, large stacked timbers act as cribbing to support the elevated house, while the jacking system is reset. In a series of small lifts, the house incrementally elevates to its final position. In some instances, it is possible to reuse portions of a foundation, but this study assumed that the older foundation would need to be removed and a new one constructed. While these assumptions could impact the price of construction, there was no consistent way to assume the percentage of foundations that are sufficient to remain as compared with the number that would need to be replaced.

Slab-on-grade (SOG) single-family houses present additional challenges. Often the slab possesses minimal reinforcement to protect it from cracking caused by thermal expansion and contraction and the minor soil changes that come with moisture. This minimal reinforcement, however, is insufficient to structurally support a slab, when it is only buttressed by a perimeter crawlspace wall or interior piers. Elevating such a slab violates concrete design standards and should be avoided for the safety of the occupants. In such instances, the walls and roof of the house become elevated and disconnect from the slab. To thoroughly retrofit SOG single-family dwellings, the construction of a new wood-framed floor system beneath the walls must be accompanied by piers to support the floor system, typically on top of the slab. In some areas, soil conditions dictate the structural reinforcement of a slab, which sometimes can be supported by below-ground piles. The elevation of a slab with the walls attached thus is dependent on sufficient reinforcement. The construction may then allow for a new foundation system that has sufficient bearing capacity to support the elevated slab house above.

As previously stated, this study only evaluated elevations between BFE-1 and BFE-4. There was significant debate on whether additional buildings below BFE-4 should be considered and whether the study should also evaluate buildings elevated to a height of eight feet regardless of the elevation to which the building initially was constructed. Even though homeowners often want to elevate to a height of eight feet or an entire story to gain additional parking space, this proposition posed two problems. First, the issue of owners reconverting spaces such as below-house garages into livable space and thus increasing the flood vulnerability of the building. Although this is not the case with every building, these conversions do occur and local officials often do not become aware of it until a flooding event damages the reconverted spaces. Often this is because a homeowner chooses to elevate their house and then sells it, and the new

homeowner is not aware of the restrictions associated with the enclosure below the lowest floor. The second issue is that insufficient data exists to understand the percentage of people who elect to elevate the additional height above BFE+1 to have sufficient space for parking. This group would be a combination of people personally funding the entire elevation and those using grant money to have their house lifted. Additionally, it was not feasible within the confines of the study to calculate the additional property value achieved by having parking below the house as compared with the available parking prior to the elevation. It is important to remember that, while residents may apply the space for other uses, the study only wants to consider allowable below-lowest-floor functionality – parking, building access, or low-value contents storage. Single-family houses below BFE-4 may be unreasonable to consider based on the increasing number of variables that this creates. Each additional foot below BFE requires the development of a cost estimate, which must consider the size of the structure, height above ground of the lowest floor in the existing state, and total foundation height after the elevation. Higher elevations can require additional structural considerations such as thicker foundation walls as well as piers and other reinforcement requirements.

The project team estimated costs using a cost-estimation tool that counts fixed costs (i.e., costs that do not depend on house size) and those that vary with the size of the building, such as length of foundation walls, foundation height, number and size of interior piers, and number of required flood openings. These cost estimates were compared with FEMA P-259, *Engineering Principles and Practices of Retrofitting Flood Prone Residential Structures 3rd Edition* (Federal Emergency Management Agency 2012e) and inflated to 2018. Additional comparisons were made with data provided by Louisiana State University Department of Construction Management. Both sources agreed with the project team's cost estimates, given adjustments to meet the needs of a national study.

#### **4.6.1.5. Selection and Analysis of Wet Floodproofing Basements of Single-Family Dwellings**

Wet floodproofing of basements represents a less expensive retrofit project that homeowners could pursue themselves. Wet floodproofing is defined here as permanent measures that allow floodwater to flow through a section of building and only require cosmetic repairs. This study evaluated retrofits to a basement area that is subject to flooding when floodwaters enter through a basement at-grade window and water fills the space. Basements for the purposes of this study are defined as space with a floor that is below grade on all sides. Wet floodproofing also could be done on walk-out basements or crawlspaces to reduce flood damage. Basement areas often are finished to varying degrees with either drywall on the exterior walls and on interior partitions. They can include some floor covering over the floor slab. Additional areas of common damage are insulation, interior finishes, and electrical systems that are not designed for contact with floodwater. The present study did not consider plumbing fixtures in the basement area, such as basement-level bathrooms. The wet floodproofing evaluation did not consider the relocation of a furnace, water heater, ductwork for upper floors, which are treated separately here.

The project team used RSMMeans Costworks to estimate the cost to replace common wall coverings with more flood-resistant materials and to move basement-level electrical systems. Flood openings also were incorporated into the cost of the system to reduce the potential for a structural failure in a basement wall when floodwaters rise above the exterior grade. These costs were then compared with costs independently developed by FEMA in FEMA P-259, *Engineering Principles and Practices of Retrofitting Flood Prone Residential Structures 3rd Edition* (Federal Emergency Management Agency 2012e) and inflated to 2018.

### 4.6.1.6. Selection and Analysis of Utility Retrofits of Single-Family Dwellings

The utility retrofits addressed here refer to modifications to the mechanical and plumbing systems for components below the lowest floor. This analysis evaluated the cost effectiveness of relocating ductwork from the underside of wood-framed floor systems to a location above the lowest floor; elevation of air conditioning or heat pump units that are commonly located beside houses; and relocation of furnaces and water heaters from basements. These mitigation measures were considered for houses that would not be elevated. They focus on common retrofits that would not result in a designation of substantial improvement. The analysis focused on flood damage to the mechanical and plumbing equipment and the benefits resulting from elevating the equipment at least to the lowest floor level of the house. Although maintaining this equipment may make the houses more comfortable, the analysis did not incorporate displacement from the houses as part of the total avoided flood damage.

Heating and air-condition ductwork commonly is installed on the underside of the lowest floor in houses with crawlspaces or basements. In one-story houses, this ductwork often can be relocated into an attic space. The furnace or air handler also can be relocated to the attic. Two-story homes are more difficult to retrofit. The second-story ductwork already is located in the attic area, and the first-floor ductwork usually is located on the underside of the first floor. Retrofitting the first-floor ductwork often requires the addition of furring around the first-floor ductwork trunk lines on the soffit of the second floor. The present analysis assumed that existing (pre-mitigation) ductwork was located approximately two feet below the finished floor of the first story and that as soon as floodwater touched the ductwork, it would need to be removed and replaced to avoid risk of spreading mold or other contamination into the house through the mechanical system.

This study also examines efforts to elevate exterior air conditioning units or heat pumps. These units often are located on concrete pads at ground level outside of houses. Lines run to either units located under the first floor or up into units placed in the attic. The mitigation often requires placement of the units onto either wooden platforms, raised concrete platforms, or onto platforms cantilevered off the house. Although there may be some variability in the height of units above the ground, the present analysis assumed existing units were located at approximately the same elevation as the ductwork in relationship to the lowest floor, or approximately two feet below the top of the lowest finished floor. To consider the potential for floodwater damage to electrical components or corrosion of unit coils, the present study made a further assumption that when floodwater touched the units, they would have to be replaced.

The present study characterizes the retrofit of these utilities as elevating furnaces and water heaters from the concrete pad to an elevation above the lowest floor. Relocation could be done into a space, such as a garage or closet above the elevation of the lowest floor or into an attic area. The relocation of a furnace unit would require reconfiguration of ductwork and associated fuel or electrical lines. Water heater relocation would require installation of fuel supply lines (either electrical or gas lines), reconfiguration of cold-water inlet piping and hot water outlet piping, and any other associated, including necessary drainage piping and flue outlets for gas-powered units. Similar to the assumptions associated with other mechanical and plumbing units, the present study assumed that when floodwater touched the units the equipment would have to be replaced. The study again referenced the location of the equipment to the lowest floor, but assumed the equipment would be 100 percent damaged at three feet below the lowest floor. This could be applied to either common crawlspace areas or water entering through basement windows and quickly filling a basement.

The project team used RSMeans Costworks to estimate the costs to relocate mechanical and plumbing equipment and to make all necessary reconfigurations to central air systems and, in the case of the water heater, the house plumbing system. These costs were compared with a web-based cost review for the installation of similar types of mechanical and plumbing work. The utility analysis should give readers an overview of the benefits of undertaking these smaller flood mitigation projects to avoid equipment damage. The present study does not count among the benefits the additional value of being able to continue using the equipment after a flood, nor does it quantify the hassle associated with replacing these items following a flood.

### **4.6.2. Selection and Analysis of Hurricane Wind Retrofit of Private-Sector Buildings**

#### **4.6.2.1. Selection and Analysis of Hurricane Wind Retrofit for the IBHS FORTIFIED Home Program for Existing Residential Structures**

Hurricane wind vulnerability is estimated here using Hazus damage functions. The project team selected the functions that most closely approximate pre-retrofit (for existing construction) and post-retrofit (IBHS FORTIFIED) conditions. The parameters that determine the damage function for the Hazus hurricane wind module include roof shape, roof-deck attachment spacing and sizing, secondary water protection, opening protection via shutters, garage door upgrades, and roof-to-wall connections. In some cases, especially where newer standards are involved and Hazus cannot incorporate deviations in design that might be reflected in these standards, the project team used judgment to scale Hazus results. In all cases, the project team applied numerous tests to ensure that modified damage functions were consistent with basic engineering principles related to wind performance and experience (e.g., incorporation of factors of safety as scalars). Especially helpful in this process has been the interaction with various trade groups, such as the Insurance Institute for Business & Home Safety. A similar methodology was employed in other parts of the study; see Sections 4.4.2 and 4.13.4.

## NATURAL HAZARD MITIGATION SAVES:

To calculate a nationwide BCR for the IBHS FORTIFIED Home program, one must select damage functions to reflect pre-mitigation (or baseline) conditions, as well as post-mitigation (retrofitted) conditions. The baseline damage function must be representative of common construction practices and minimum building code requirements in force at the time of construction. Note that pre-mitigation manufactured homes are not uniform. Newer homes were built to stricter standards even without retrofit, under codes that evolved as described in Section 3.8.2.1.

The project team chose two baseline conditions: (1) single-family dwellings built before Hurricane Andrew in 1992 in compliance with older legacy codes (National Building Code and Standard Building Code), and (2) after Hurricane Andrew in compliance with modern I-Codes (the International Residential Code, IRC). Hazus damage models include mitigation options. The appropriate Hazus mitigation options were chosen based on the prescriptive and some performance-based requirements. Homes located in regions of higher basic wind speeds have a separate set of Hazus baseline parameters, as design requirements change based on the increased design pressures. Hazus offers a finite set of options that sometimes do not exactly match the conditions the project team needed to model, so the team chose the closest option and in some cases scaled the damage function by a constant factor to better reflect conditions consistent with the respective codes.

For example, code-compliant fastener schedules for roof sheathing were checked for comparison with the FORTIFIED Roof designation. Pre-Andrew sheathing attachment was modeled using 6d nails with 6-inch edge spacing and 12-inch field spacing. The project team modeled post-Andrew sheathing connections for buildings in regions with ASCE 7-16 wind speeds of at least 130 mph using 8d nails with 6-inch edge and 6-inch field spacing. In locations with ASCE 7-16 design wind speeds less than 130 mph, the project team modeled roof-sheathing connections with 8d nails with 6-inch edge spacing and 12-inch field spacing. The IRC opening protection requirements for wind-borne debris regions (ASCE 7-16 design wind speed greater than 130 mph and less than one mile from the coast, or greater than 140 mph regardless of coastal distance) was checked for comparison with the FORTIFIED Silver designation. Opening protection was modeled with wood structural panels as temporary shutters. No opening protection was assigned for the legacy codes. For comparison with the Gold designation, uplift values were calculated and checked to see if the three 8d nails for the roof-to-wall connection were capable of resisting the uplift values, or if hurricane straps were required.

Likewise, the project team selected the most similar Hazus damage models to reflect IBHS FORTIFIED Roof, Silver, and Gold designations. The prescriptive requirements for each designation were identified and the appropriate Hazus mitigation options were selected. FORTIFIED Roof requires adding ring shank nails between existing fasteners. The project team modeled this measure using 8d nails at 6-inch edge and 6-inch field spacing. Hazus cannot appropriately model the additional pullout capacity of ring shank nails and closer nail spacing (4-inch spacing) for roof sheathing. IBHS engineers estimated a constant reduction factor for the closest Hazus damage model to reflect the expected damage.

## NATURAL HAZARD MITIGATION SAVES:

FORTIFIED Roof designation adds secondary water resistance, which is not required by either legacy or I-Codes. All structures (regardless of location) also were modeled with opening protection products to satisfy the FORTIFIED Silver requirements. The project team assumed installation of metal hurricane shutters, given that they are commonplace and relatively inexpensive to install. For regions where the ASCE 7-16 design wind speed is less than 120 mph, the project team modeled wood structural panels as temporary shutters, as allowed by the current FORTIFIED standards. For FORTIFIED Gold designation, all residences are modeled with hurricane straps, regardless of the calculated roof uplift values.

Inadequate damage models exist to reflect certain retrofit measures of the IBHS FORTIFIED program. These include retrofitting gable ends (FORTIFIED Roof and Silver), retrofitting soffits (FORTIFIED Roof), improving anchorage of attached structures (Silver), securing chimneys to the structure (Gold), and improving wall shear strength and anchorage (Gold). The reader can find a full list of the required IBHS FORTIFIED retrofit features in the latest edition of the IBHS Hurricane Standards. For the features that could not be modeled, the project team considered neither the benefits nor the costs. Thus, unmodeled costs and benefits would accrue if such retrofits were completed.

To characterize the number of structures exposed, the project team obtained 2010 U.S. Census population and building data at the census-tract level. These data contain counts of single-family dwellings, their location (latitude and longitude), and an estimate of the building age distribution by decade of construction, by census tract. The project team used these data to calculate the number of pre- and post-dwellings by census tract. The project team used a geographic information system to overlay census-tract boundaries and the ASCE 7-16 wind speed maps, and calculated the total number of dwellings by age and wind band. Each bin—each combination of age and wind speed—was analyzed for each FORTIFIED Roof, Silver, and Gold retrofit option. Resulting reductions in losses between the non-retrofitted options were aggregated by ASCE 7-16 wind bands, and ultimately rolled up to calculate nationwide totals.



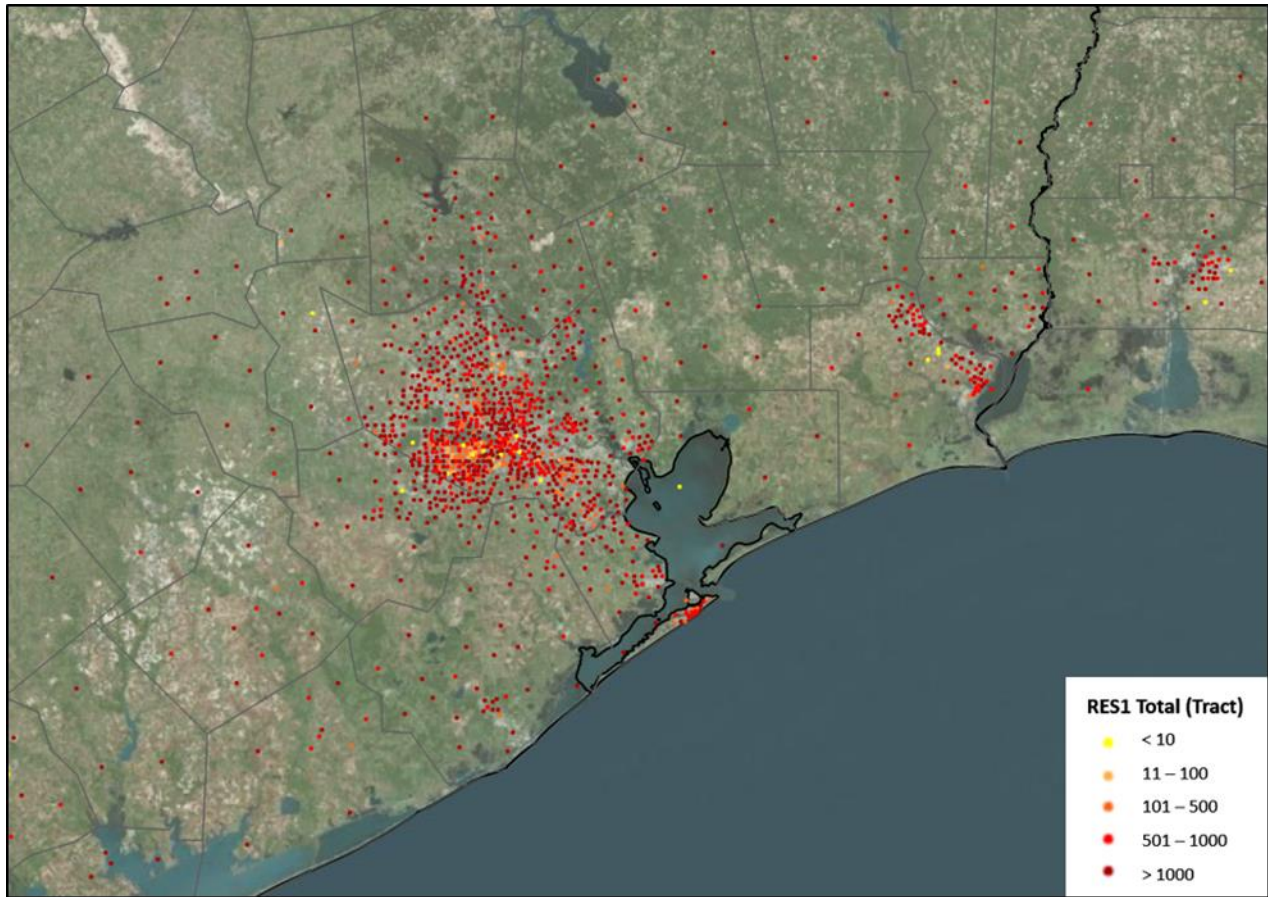

Figure 4-2: Location and count of RES1 tracts from 2010 Census (Houston, TX is shown in the center).

The project team estimated the cost of retrofit using several sources. IBHS provided component-level cost estimates for each FORTIFIED retrofit designation. The project team also used RSMean and Xactimate to create an itemized database of quantities for each FORTIFIED requirement. The project team compared these costs with those provided in FEMA P-804 (Federal Emergency Management Agency 2010), which as previously noted closely relates to the IBHS program. FEMA’s cost estimates agreed with those of IBHS within 10%.

#### 4.6.2.2. Selection and Analysis of Hurricane Wind Retrofit for Manufactured Housing

The project team acquired the U.S. Department of Homeland Security (DHS) Homeland Infrastructure Foundation-Level Data (HIFLD) database of individual manufactured housing complexes created for emergency preparedness and evacuation purposes. Each record provides the location (latitude and longitude) and the size of the complex in three ranges: A small complex means fewer than 50 homes. Medium means 51 homes to 100 homes. Large means more than 100 homes. The database does not report the exact number of manufactured homes in each complex. So the project team acquired estimates of the number of manufactured homes by county from the U.S. Census Bureau’s 2017 American Community Survey (<https://www.census.gov/programs-surveys/acs>). With both the total number of homes

## NATURAL HAZARD MITIGATION SAVES:

and count of small, medium and large complexes known per county, the project team estimated a weighted average count of homes per small, medium, and large complex, and applied these weighted averages to the HIFLD complex locations.

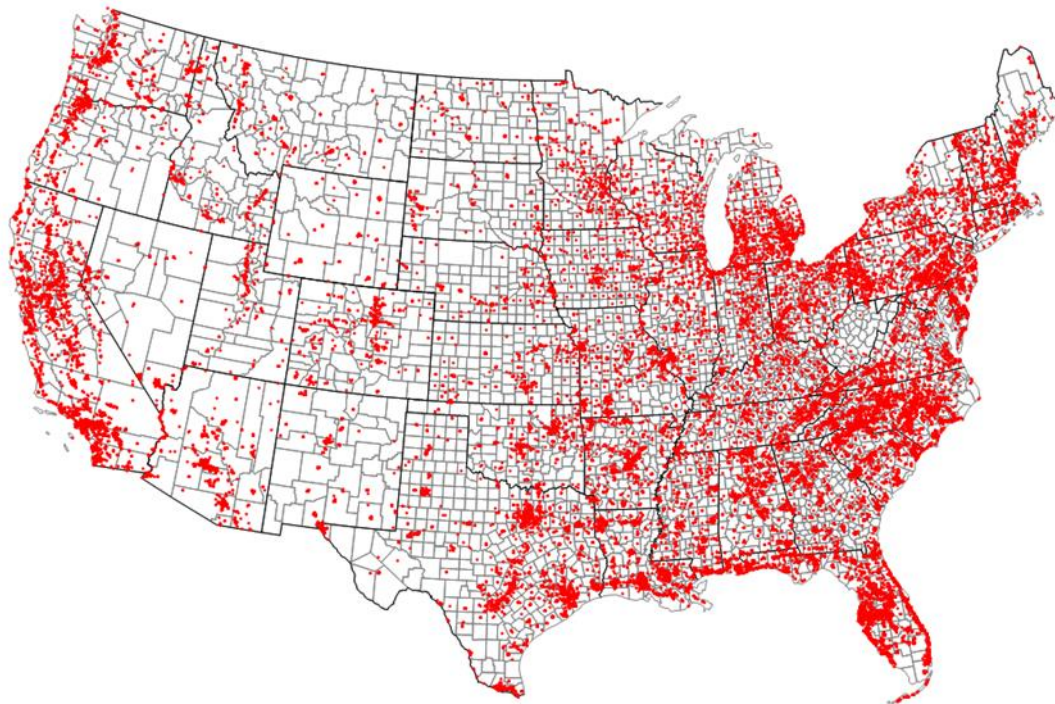

**Figure 4-3:** Location of Manufactured Housing Complexes per the U.S. Department of Homeland Security

The project team used a geographic information system to calculate the ASCE 7-16 wind hazard for each complex. Hazus uses HUD wind zone as one of its damage-functions parameters for manufactured housing. This parameter was taken from the U.S. Code of Federal Regulations, Title 24, section 3280.305, which identifies each county's wind zone.

Since most existing manufactured homes already are tied down, the project team needed to estimate the percentage of homes that currently are not anchored to their foundation. Statistics from the U.S. Census Bureau (2018-KP2) provide estimates of unanchored manufactured homes for seven states and 43 metropolitan areas. In regions specifically identified by the U.S. Census Bureau (e.g., Florida cities), the applicable percent of unanchored homes was used for the analysis. For states and cities not identified, a regional average was calculated based on those listed states and metropolitan areas in the Census data. Based on an average of the 18 Census locations listed within the hurricane-prone regions, the project team estimates 12% of manufactured homes in the eastern United States are unanchored. A state-by-state and proxy breakdown of unanchored manufactured housing units can be found in Section 4.6.3.2 of the seismic retrofit for manufactured housing (Table 4-5).

## NATURAL HAZARD MITIGATION SAVES:

To estimate the age distribution for each complex, the project team used a database of manufactured housing by year built, provided by HUD and taken from the 2017 American Housing Survey (see the U.S. Census Bureau’s American Housing Survey Table Creator <https://www.census.gov/programs-surveys/ahs/data/interactive/ahstablecreator.html>). The database that the project team used provides the number of manufactured housing units built per decade by census division (e.g. New England, Middle Atlantic, South Atlantic, etc.). To estimate counts before the advent of the Manufactured Home Construction and Safety Standards in 1976, the project team assumed 60% of the total count between 1970 and 1979 predate the standard. The project team likewise assumed that 60% of the total count between 1990 and 1999 post-dated the 1994 addition of wind zones to the standards and its associated changes to construction and installation.

**Table 4-3: Age Distribution by Census Division**

Year Built	New England	Middle Atlantic	East North Central	West North Central	South Atlantic	East South Central	West South Central	Mountain	Pacific
1930 to 1939	0	3,286	0	8,902	11,436	14,955	5,920	3,642	10,264
1940 to 1949	813	0	5,563	2,126	18,699	9,156	12,846	5,018	0
1950 to 1959	372	21,012	12,223	199	32,581	10,119	14,489	26,455	24,746
1960 to 1969	3,807	38,471	66,711	30,859	151,129	42,822	45,099	48,778	98,234
1970 to 1979	52,431	126,042	172,835	114,774	409,492	112,437	166,700	292,666	279,956
1980 to 1989	19,475	94,767	113,245	90,144	622,843	223,137	329,201	207,267	187,535
1990 to 1999	16,367	93,537	238,324	117,780	717,936	336,058	333,934	199,373	149,269
2000 to 2009	25,768	48,594	101,157	51,400	361,986	176,001	314,736	155,259	106,174

## NATURAL HAZARD MITIGATION SAVES:

Year Built	New England	Middle Atlantic	East North Central	West North Central	South Atlantic	East South Central	West South Central	Mountain	Pacific
2010 to 2017	2,573	43,915	38,967	29,773	85,836	39,309	121,761	29,750	23,531
Total	121,607	469,624	749,025	445,957	2,411,939	963,993	1,344,687	968,207	879,710

Using the estimates of the age distribution, locations, counts, wind hazard, and wind vulnerability of manufactured housing along the Gulf and Atlantic coasts, the project team estimated the benefits and costs of engineered tie-down systems. Hazus provides fragility functions for five groups of manufactured housing, denoted here by pre-HUD (prior to 1976), 1976 HUD (1976-1993), 1994 HUD Wind Zone I, 1994 HUD Wind Zone II, and 1994 HUD Wind Zone III.

It appears that engineered tie-downs provide little benefit to pre-1976 manufactured housing, whose vulnerabilities in the structure above the frame make securing the frame to the ground fairly immaterial to wind loss. The ETS does not help much because there are weaker links in the chain. Pre-HUD (construction prior to 1976) manufactured homes therefore are ignored in this analysis. (Section 5.9.2 provides a sensitivity analysis that includes benefit-cost ratio for scenarios where pre-HUD manufactured homes are included, as well as an isolated analysis of post-1994 HUD homes only).

An important consideration for ETS: Because of the relatively low cost of manufactured housing, residents often have lower income, higher vulnerability, and may be less able to recover from costly damage to their home. The project team has not attempted to quantify the costs and benefits of ETS (or other mitigation measures) particularly for vulnerable populations, or somehow to reflect the disproportionate benefits that mitigation provides to these populations. It merely recognizes that the issue exists, and could be addressed by other studies.

### 4.6.3. Selection and Analysis of Seismic Retrofit of Private-Sector Buildings

#### 4.6.3.1. Selection and Analysis of Seismic Retrofit for Soft-Story Wood Frame Multifamily Dwellings

The project team reviewed the available loss models for soft-story wood-frame buildings without and with seismic retrofits. Among the options the team reviewed, the vulnerability functions developed for the CAPSS soft-story study (Porter and Cobeen 2009) seem to best suit the project needs. Their advantages are several: (1) They offer relationships between repair costs, damage states, and ground motions for particular, practical retrofit designs; (2) They use something close to state-of-the-art performance-based methods; (3) Prominent structural engineers peer reviewed them; (4) Their construction costs were estimated by professional cost estimators; (5) They form the basis of a major mandatory seismic retrofit; and (6) They reflect some of the diversity of soft-story buildings.

Disadvantages of the CAPSS vulnerability functions include that (1) They were based on nonlinear pseudostatic structural analysis rather than nonlinear dynamic structural analyses—the latter of which generally is believed to better reflect reality; and (2) The vulnerability functions purely are analytical, without laboratory tests to support them. Other options such as Mar and Korolyk (2012) offer something closer to state-of-the-art structural analysis, while the NEES-Soft studies (e.g., van de Lindt et al. 2013) offer the benefit of laboratory testing, but these alternatives lack one or more features required for the present analysis, especially the seismic vulnerability functions and costs of particular retrofit designs.

For practicality, the project team chose to reflect the equally weighted average of the costs and vulnerability functions of the four CAPSS buildings. The CAPSS project estimated costs in 2008 in San Francisco. The project team updated the construction cost to account for inflation using RSMeans' ratio of the national location cost index to that of San Francisco, and RSMeans' inflation cost factors for 2018 and 2008. The CAPSS vulnerability functions only express mean damage factor for building repair cost and the Hazus-style structural damage states. Most of the other loss categories are directly calculated from these, as detailed in Appendix K. The exception is content repair cost, which is recalculated as shown in Appendix K from original, unpublished CAPSS data having to do with spectral acceleration response at each performance point.

### 4.6.3.2. Selection and Analysis of Seismic Retrofit for Manufactured Housing

ETS seem to provide good seismic restraint for manufactured housing at fairly modest cost and simultaneously resist overturning in strong winds, suggesting a common and potentially cost-effective method for retrofitting manufactured housing for both wind and earthquake. The project team derived an earthquake collapse fragility function for manufactured housing prior to the addition of ETS using the survey data gathered by the California Department of Housing and Community Development (1991), discussed in Section 3.8.3.2, using standard methods offered by Porter et al. (2007) for performance-based earthquake engineering.

Correlation between collapse rate and either peak ground acceleration or peak ground velocity is very poor. Of the two measures of ground motion, peak ground velocity correlates with collapse probably slightly more strongly, but exhibits a coefficient of determination less than 0.1. One can say little more about the data of peak ground velocity and collapse rate than that, at peak ground velocities between 20 and 60 cm/sec, about 1 in 4 manufactured homes collapsed. Table 4-4 and Figure 4-4 show the Loma Prieta collapse data. Circles in the figure indicate individual manufactured housing development surveyed by California Department of Housing and Community Development (1991) after the 1989 Loma Prieta earthquake. Each park is assigned the value of peak ground velocity recorded at the nearest strong-motion instrument, according to the US Geological Survey's event page for that earthquake (<https://earthquake.usgs.gov/earthquakes/eventpage/nc216859/>, retrieved November 27, 2018).

Data for 17 of the largest parks are shown, representing approximately 92% of the units surveyed. The diamond represents the weighted average of the parks data, weighted by number of homes per park. The peak ground velocity for the diamond, 40 cm/sec, is calculated as the weighted average of the values in

## NATURAL HAZARD MITIGATION SAVES:

the table, weighted by number of units. The collapse rate for the diamond is calculated as the total number of collapses in the table divided by the total number of units in the table. The smooth curve shows a lognormal cumulative distribution function with median of 69 cm/sec and standard deviation of the natural logarithm equal to 0.8, which can be used as a collapse fragility function for manufactured housing without positive restraint.

**Table 4-4:** Manufactured housing performance in the 1989 Loma Prieta earthquake.

Name	Lat	Lon	PGV cm/sec	Units	Collapses	Collapse rate
Hill Haven Trailer Park	37.150	-121.806	12	44	2	5%
Morgan Hill Apartments and Trailer Park	37.135	-121.658	26	25	12	48%
Green Valley Estates	36.941	-121.795	26	105	57	54%
Colonial Manor	36.931	-121.791	26	71	8	11%
Meadow Manor	36.934	-121.770	26	276	14	5%
Freedom Mobilehome Park	36.972	-121.869	26	45	13	29%
Vista Del Lago	37.040	-122.029	26	202	1	0%
Pacific Mobile Estates	36.998	-121.573	29	178	36	20%
Hacienda Valley	37.158	-121.674	30	165	14	8%
Wagon Wheel	37.019	-121.571	39	121	9	7%
Rancho Cerritos	36.919	-121.858	40	144	92	64%
Pinto Lakes Estates	37.006	-121.934	53	174	82	47%
Monterey Vista Mobile Estates	36.924	-121.791	53	122	70	57%
Old Mill Mobilehome Park	36.990	-121.958	53	39	14	36%
Portola Heights	36.920	-121.764	53	119	10	8%
Mission Oaks Mobilehome Park	36.852	-121.424	63	225	120	53%
Madrone Estates	37.146	-121.894	66	173	8	5%
Total			40 <sup>(1)</sup>	2,228	562	25%
Fraction of homes surveyed by California Department of Housing and Community Development (1991)				92%	95%	

1. Weighted average PGV, weighted by units

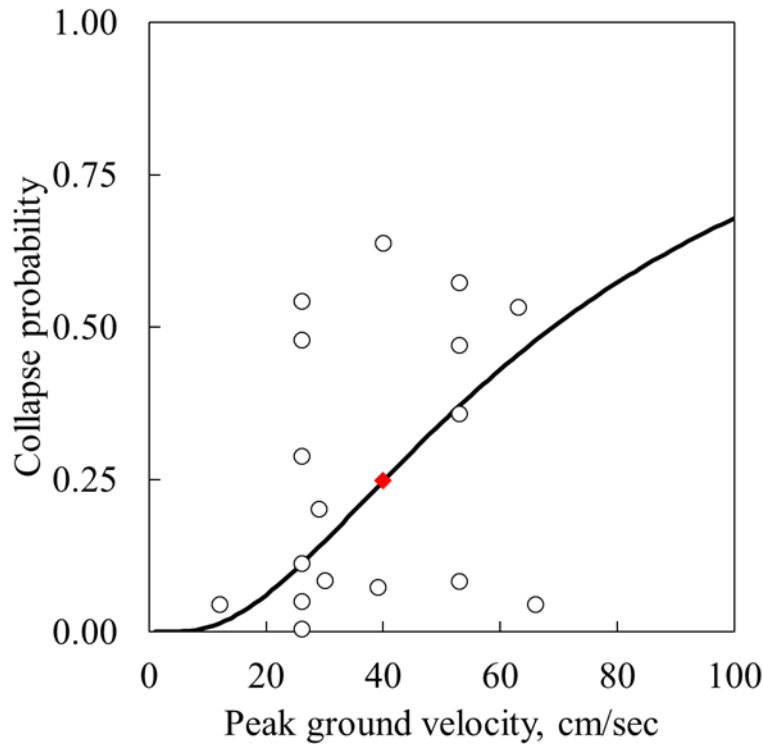

Figure 4-4: Fragility function and collapse data for manufactured housing in the epicentral region of the 1989 Loma Prieta earthquake.

The project team estimated building repair cost resulting from collapse as \$17,400 per collapse, based on the California Department of Housing and Community Development’s (1992) data, increased by a factor of 2.36 to account for inflation (using RSMMeans historical cost indices for July 1990 and July 2018—94.3 and 222.9, respectively), producing a 2018 loss estimate of \$41,129 per collapse. The project team estimated content loss conditioned on collapse as \$0.27 per \$1.00 of building repair cost, consistent with the insurance loss data offered by Steinbrugge and Schrader (1979).

To estimate casualty risk, consider that two deaths occurred among the 6,000 manufactured homes that collapsed from their foundations in the 1994 Northridge earthquake. Assuming the average unit had an area of 1,440 sf (a 24 ft by 60 ft double-wide, which is fairly common) and an occupancy load consistent with the Hazus inventory (631 sf/occupant), Northridge data suggest a fatality rate of 0.015% among collapsed manufactured homes, consistent with Hazus-MH’s recommended an indoor fatality rate of 0.01% for manufactured homes that suffer complete structural damage without collapse. (Hazus’s 5% fatality rate among the collapsed area of manufactured houses seems unreasonably high.)

For nonfatal injuries conditioned on the manufactured home falling from its supports, the project team applied the Hazus injury rates corresponding to the complete structural damage without collapse: 5% in Hazus injury severity level 1, 1% in severity level 2, 0.01% in severity level 3, and 0.01% experiencing post-traumatic stress disorder, as in Section 4.19.2. Some of these injuries would occur regardless of whether

## NATURAL HAZARD MITIGATION SAVES:

the manufactured home fell from its supports, owing to behavior, contents, etc. The resulting vulnerability functions are calculated as collapse probability times severity of loss given collapse, and are illustrated in Figure 4-5.

Not shown in the figure are losses for other categories: repair duration, additional living expense losses, and indirect business interruption, which are taken as the same as elsewhere in this study for residential buildings affected by earthquakes.

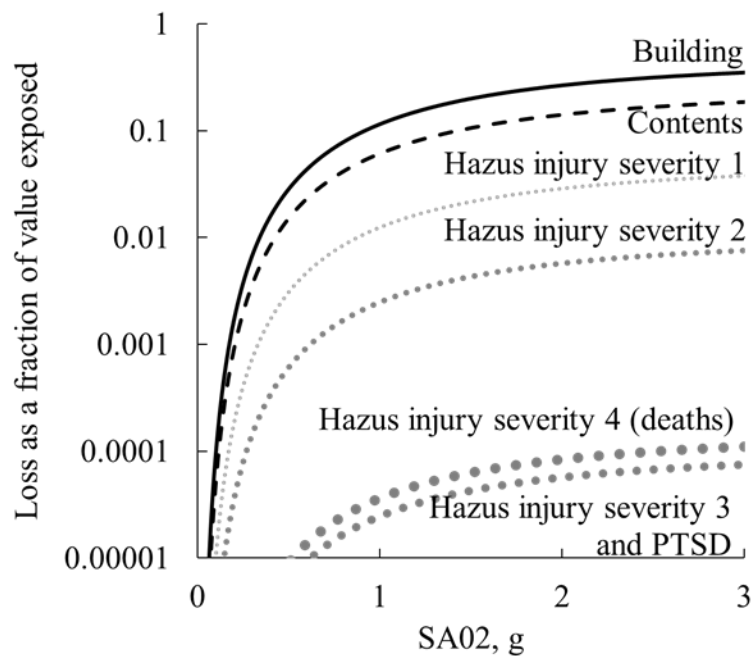

**Figure 4-5:** Vulnerability functions for manufactured housing without an engineered tie-down system.

To estimate manufactured housing vulnerability with the retrofit, the project team assumed that the addition of the retrofit makes the units effectively rugged to resist collapse. That is not to say that the project team assumed that the retrofitted units cannot collapse in reality, but rather that the collapse probability is so small after retrofit that for purposes of benefit-cost analysis, it might as well be treated as zero. Contents probably fall regardless of whether the building collapses, but at a lower rate. The project team assumed that half the content loss is associated with collapse and accordingly reduced the content vulnerability. Nonfatal injuries are (Hazus severity levels 1, 2 and 3 and post-traumatic stress disorder) similarly are taken as half the values for the non-retrofitted case, since nonfatal injuries tend to be more associated with nonstructural items and behavior. Additional living expenses and indirect business interruption are taken as zero absent collapse.

To estimate the fraction of manufactured housing units that are not anchored to their foundation, the project team recognized that the fraction varies geographically and used U.S. Census Bureau (2018-KP2) statistics where applicable. It was estimated that in the western United States, the fraction is approximately 30%; this includes Montana, Wyoming, Colorado, New Mexico, and states west. The fraction is estimated



## NATURAL HAZARD MITIGATION SAVES:

to be 12% in the central and eastern regions of the country, which includes 48 conterminous states. See Table 4-5 for the estimated fraction of manufactured housing units not currently anchored to their foundations. In the table, WUS refers to the western United States, and CEUS refers to the central and eastern United States.

**Table 4-5:** Fraction of manufactured housing units not anchored to their foundation. Units not reporting anchorage condition are not shown in the table.

StateFIPS	State	% not anchored	Anchored, 1000s	Not anchored, 1000s	Proxy, where statewide estimates are unavailable
01	AL	12%			CEUS
04	AZ	21%	64.4	17.1	Phoenix MSA
05	AR	12%			CEUS
06	CA	38%	242.5	147.1	
08	CO	28%	67.7	26.0	
09	CT	23%	2.7	0.8	Hartford MSA
10	DE	12%			CEUS
11	DC	13%	10.8	1.6	Washington MSA
12	FL	13%	475.7	72.4	
13	GA	14%	48.8	7.7	Atlanta MSA
16	ID	30%			WUS
17	IL	16%	14.5	2.7	Chicago MSA
18	IN	12%			CEUS
19	IA	12%			CEUS
20	KS	23%	8.6	2.5	Kansas City MSA
21	KY	4%	22.5	1.0	Louisville MSA
22	LA	12%	13.7	1.8	New Orleans MSA
23	ME	12%			CEUS
24	MD	7%	10.5	0.8	Baltimore MSA
25	MA	31%	2.4	1.1	Boston MSA
26	MI	12%			CEUS
27	MN	19%	16.4	3.9	Minneapolis-St. Paul MSA
28	MS	6%	35.3	2.4	Jacksonville MSA
29	MO	23%	8.6	2.5	Kansas City MSA
30	MT	30%			WUS

## NATURAL HAZARD MITIGATION SAVES:

StateFIPS	State	% not anchored	Anchored, 1000s	Not anchored, 1000s	Proxy, where statewide estimates are unavailable
31	NE	12%			CEUS
32	NV	22%	15.8	4.5	Las Vegas MSA
33	NH	12%			CEUS
34	NJ	20%	12.6	3.1	Northern New Jersey MSA
35	NM	30%			WUS
36	NY	26%	130.1	46.6	
37	NC	10%	26.0	2.8	Raleigh MSA
38	ND	12%			CEUS
39	OH	12%	135.4	18.6	
40	OK	9%	27.5	2.6	Oklahoma City MSA
41	OR	31%	21.9	9.9	Portland MSA
42	PA	37%	95.7	55.9	
44	RI	12%			CEUS
45	SC	12%			CEUS
46	SD	12%			CEUS
47	TN	13%	15.4	2.2	Memphis MSA
48	TX	9%	558.9	54.8	
49	UT	30%			WUS
50	VT	12%			CEUS
51	VA	18%	10.3	2.2	Richmond MSA
53	WA	13%	41.0	6.0	Seattle MSA
54	WV	12%			CEUS
55	WI	32%	1.9	0.9	Milwaukee MSA
56	WY	30%			WUS

As noted in Section 3.8.3.2, the population in manufactured homes tends to have lower household income than the general population, and approximately 29% have income below the federal poverty line.

But at the national level, occupants of manufactured homes do not seem to be significantly older than the general population of householders: The mean age of the former is 53; the latter, 52, and the probability distributions are very similar (Figure 3-5). It seems reasonable therefore not to attempt to adjust casualty rates for manufactured homes. However, the lower income level of occupants of manufactured homes

suggests that they would be less able to afford repairs, and might be displaced longer than the general population suffering similar levels of loss.

What about fires? Among the 2,432 manufactured homes in the survey by California Department of Housing and Community Development (1991), in addition to the 592 that collapsed, the survey report notes that "In addition to the homes that went down during the Loma Prieta earthquake, four (4) homes were destroyed. Two (2) of these homes were structurally damaged beyond repair and two (2) others were burned." This suggests that, while fires do occur and their occurrence is probably influenced by collapse of the manufactured house, loss does not appear to greatly be aggravated by fires. One reasonably can estimate collapse damage to manufactured houses without amplifying the effect to account for fire following earthquake.

It is necessary to show that the same engineered tie-down system works as both seismic and wind retrofit. As a test case, consider a double-wide manufactured house measuring 28 ft by 56 ft (1568 ft<sup>2</sup>) by 14 ft tall, including the skirt and weighing  $W = 25000$  lb. As a test of high seismicity, let it be located in Palm Springs, California (33.788N, 116.479W). Palm Springs is in one of the highest seismicity regions in the state. Let us say the home is secured to the ground with an ETS rated for the current design wind load at that location. It has no supplemental seismic restraint. Assume mean shearwave velocity in the upper 30 meters of soil ( $V_{s30}$ ) equal to 293 m/sec (site class D), using the Wills et al. (2015) site classification map developed for the California Geological Survey. Let the seismic loading be as described in ASCE 7-16. The designer must ask:

1. What is the design lateral wind load that must be resisted by the ETS?
2. What is the design lateral seismic load that must be resisted by the ETS?
3. Is the ETS sufficient to restrain the home against the seismic loads that would be specified for a modern wood-frame dwelling of the same dimensions at the same location?

This is an enclosed simple diaphragm building per ASCE 7-16 section 26.2, so one can use ASCE 7-16 chapter 27 part 2. The building is risk category II and occupancy category II. Its basic wind speed  $V = 97$  mph per Applied Technology Council Hazards by Location application at <https://hazards.atcouncil.org/#/wind?lat=33.788&lng=-116.479>. The wind directionality factor,  $K_d$ , per Section 26.6, Table 26.6-1, is 0.85. Its exposure category, per section 26.7, has surface roughness B (suburban area) upwind for 1500 ft, and therefore exposure category B. The topographic factor,  $K_{zt}$ , per Section 26.8, for a level site is 1. Its enclosure classification, per section 26.10, is enclosed building.

$$\begin{aligned} p_0 = p_n &= 16.7 \text{ transverse direction from ASCE 7-16 Table 27.6-1} \\ &= 14.5 \text{ longitudinal direction from ASCE 7-16 Table 27.6-1} \end{aligned}$$

$$\begin{aligned} A &= 56 \text{ ft} \cdot 14 \text{ ft} = 784 \text{ ft}^2 \text{ (transverse direction)} \\ &= 28 \text{ ft} \cdot 14 \text{ ft} = 392 \text{ ft}^2 \text{ (longitudinal direction)} \end{aligned}$$

## NATURAL HAZARD MITIGATION SAVES:

$$\begin{aligned}F_{\text{wind}} &= 16.7 \text{ psf} \cdot 784 \text{ ft}^2 = 13093 \text{ lbf (transverse direction)} \\ &= 14.5 \text{ psf} \cdot 392 \text{ ft}^2 = 5684 \text{ lbf (longitudinal direction)}\end{aligned}$$

Seismic load:

$$S_{DS} = 1.084g, \text{ per Applied Technology Council Hazards by Location application at } \underline{\underline{\a href="https://hazards.atcouncil.org/#/seismic?lat=33.788&lng=-116.479">https://hazards.atcouncil.org/#/seismic?lat=33.788&lng=-116.479}}$$

$$R = 6.5 \text{ per ASCE 7-16 Table 12.2-1}$$

$$I = 1.0$$

$$\begin{aligned}C_s &= S_{DS}/(R/I) \text{ per ASCE 7-16 Equation 12.8-2} \\ &= 1.057/6.5 = 0.16\end{aligned}$$

$$\begin{aligned}V &= C_s \times W \text{ per ASCE 7-16 Equation 12.8-1} \\ &= 0.16 \cdot 25,000 \text{ lb} \\ &= 4000 \text{ lbf} < F_{\text{wind}} \text{ for longitudinal wind} < F_{\text{wind}} \text{ for transverse wind}\end{aligned}$$

Since the seismic design base shear is less than wind lateral load in either direction, an ETS designed to be just sufficient to restrain the home against wind loads will be more than sufficient to restrain the building against seismic loads. The fact that these calculations ignored the net lateral wind load on the roof means the ETS would have to be stronger than indicated, even more able to resist seismic loading. Also, the ETS is probably even stronger than implied here. It is likely overdesigned because it must be sufficient for taller buildings (i.e., a bigger sail), higher basic wind speed, and it has to resist uplift as well as lateral loading, which would increase design load and therefore design strength of the components.

One can conclude that an ETS designed for California winds would be sufficient to resist the design seismic forces for manufactured housing in the highest seismic hazard location in the state for a building on the worst soil. The implication is that in other places, where wind speeds are higher or ground motions lower, an ETS designed for wind would be even better able to resist seismic forces.

### 4.6.3.3. Selection and Analysis of Securing Residential Furnishings, Fixtures, Equipment, and Contents

Among the Earthquake Country Alliance's list of 48 ways to secure your space, five seem particularly commonly performed, likely to apply to large numbers of people and be cost effective:

1. Securing water heaters to the building frame
2. Adding child safety latches to kitchen cabinets
3. Securing bookcases, shelving, and display cases to the building frame
4. Strapping desktop electronics, especially freestanding monitors and televisions
5. Securing fragile objects on shelves or in display cases with museum putty

## NATURAL HAZARD MITIGATION SAVES:

These five measures are examined here. As with other mitigation measures examined in this study, to perform a benefit-cost analysis of mitigation, one needs to know:

1. Values exposed to loss. Section 3.8.3.3 discusses available literature on values exposed to loss, although some judgment is required to assign quantities and replacement cost to particular kinds of residential contents. The project team found it necessary to estimate some of the values exposed to loss, as will be discussed later in this section.
2. Mitigation cost. To estimate mitigation cost here means finding the retail price of common mitigation materials, such as museum putty and estimating the time required to perform the measure. This assigns a value to the homeowner's time. The project team used the value of volunteer time, as described in Section 3.8.3.3.
3. Fragility of the items under as-is and what-if-mitigated conditions. Fragility information comes from FEMA P-58, with two notable exceptions: FEMA P-58 does not offer fragility information for hot water heaters or freestanding monitors. New fragility functions are presented later in this section.
4. Consequences of damage in terms of repair costs, life-safety impacts, and time-element losses. Some of these can be taken as the replacement cost and value of time to clean up the damaged component, such as freestanding monitors and televisions. Others lack existing models of consequences, such as overturning of bookcases. The items whose consequences are not available in the existing literature are developed later in this section.
5. Life of the mitigation measure. The life of water heater remediation has as its upper bound the life of the water heater. Child safety latches are effective until the cabinet doors are replaced. Remediation of bookcases, desktop electronics, and fragile objects on shelves can last only as long as the tenure of the tenant or homeowner in the home. The project team took these durations as described in Section 3.8.3.3.

Water heater fragility function. The FEMA P-58 database does not contain fragility function for an unsecured hot water heater, so one is developed here. Residential water heaters generally take the form of a vertical tank with a base of 1.5 ft to 2 ft and a height of 4 ft to 5 ft. In the case of most residential buildings, they are at or near ground level, as illustrated in Figure 4-6. FEMA P-58 offers fragility functions for overturning of various objects, but not unanchored water heaters. However, one can treat them as rigid blocks. FEMA P-58 also lacks a fragility function for the overturning of a rigid block, but one readily can derive such a fragility function.

"Rigid block" is a generic term referring to the multitude of unsecured furnishings that can overturn in earthquake shaking. The project team developed a generic and simplified rigid-block fragility function and applied it to unanchored water heaters. It is common to assume that a block overturns when peak floor acceleration makes the force vector acting on its center of gravity point outside its footprint, but the fact is that dynamics make that model too simple and wrong. In addition to aspect ratio, object size matters as well as base-motion pulses.



Figure 4-6: Typical residential water heater.

Makris and Zhang (1999) and several subsequent authors offer an analytical solution for the overturning of a rigid block. Makris and Zhang consider the response of a block to a sinusoidal pulse, which the reader can think of as the strongest back-and-forth shaking, during the earthquake ground motion. The essential elements are these: overturning depends on the amplitude of an acceleration pulse  $a$ , the slenderness of the object  $\alpha$  (the arctangent of block's base divided by its height), the angular frequency of the pulse  $w$ , and the frequency parameter of the block  $p$ , which has to do with its size and is shown in Figure 4-7. Equations Equation 4-12, Equation 4-13, and Equation 4-14 define  $p$  and other important parameter values. In the equations,  $g$  is the acceleration due to gravity,  $b$  is the width of the block, and  $h$  is its height.

$$p = \sqrt{\frac{3g}{4R}}$$

Equation 4-12

$$R = \frac{1}{2} \sqrt{b^2 + h^2}$$

Equation 4-13

$$\alpha = \arctan\left(\frac{b}{h}\right)$$

Equation 4-14

Figure 4-7 shows the model: The gray area shows the combination of these values that lead to overturning, either on the first tip (the large gray space in the upper left labeled “overturning with no impact”) or after rocking once (the lower gray lobe labeled “overturning with one impact”).

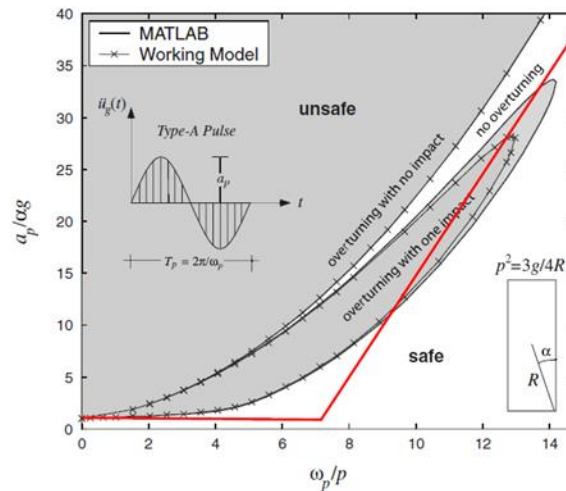

Figure 4-7: Overturning of rigid blocks (after Kostanidis and Makris 2010).

One can simplify the failure space as shown with the red lines in Figure 4-7, which separate the unsafe space from the safe space show in Equation 4-15. In the equation,  $a_p$  is the amplitude of the floor-motion pulse (defined in terms of ground motion later).

$$\frac{a_p}{\alpha \cdot g} > 1$$

$$> 5 \cdot \left( \frac{\omega_p}{p} - 7 \right)$$

Equation 4-15

To relate an earthquake to a sinusoidal pulse, one can make the following approximation. For objects located above the ground floor, the natural frequencies of the building tend to dominate motion, so the pulse frequency  $\omega_p$  is taken to be the angular frequency of the building’s fundamental period of vibration. For objects on the ground floor, the pulse period is that of the ground motion. Ground-level  $\omega_p$  can be estimated based on Somerville’s (1998) relationship between pulse period and magnitude, where the pulse-period grows in relationship to the fault dimension. For earthquakes of magnitude between 6.5 and 7.5, that period can be taken as approximately 3 seconds, so at ground level,  $\omega_p$  is taken here as 2 rad/sec. To account for uncertainty (introduced in part by simplifications shown here), one can take the boundary between the unsafe and safe spaces as the median capacity of the object to resist overturning and assume a logarithmic standard deviation of 0.4, as suggested by Porter et al. (2007). Thus, we estimate the probability that a rigid block overturns as

$$p_0(a) = \Phi\left(\frac{\ln(a/\theta)}{\beta}\right)$$

Equation 4-16

where

$a = S_a(3.0 \text{ sec}, 5\%)$  for rigid blocks at ground level

$= S_a(T, 5\%)$  for rigid blocks at upper floors of a building whose fundamental period is approximately  $T$

$\theta = \alpha g$

$\geq 5\alpha g(2/p - 7)$  for rigid blocks at ground level

$\geq 5\alpha g(\omega_p/p - 7)$  for rigid blocks at upper floors

$\beta = 0.4$

With the dimensions and ground-story location of a typical water heater, one can create the following fragility function. First, with the parameter values shown here,  $p$  is  $3 \text{ sec}^{-1}$ ,  $\alpha$  is  $0.3 \text{ (rad)}$ , so  $\theta$  is  $0.3 \text{ g}$  in terms of SA30, or if using SA10 or PGA,  $\theta$  is  $0.9\text{g}$ , or if SA03, about  $2.25\text{g}$ , each with  $\beta = 0.4$ . Notice that  $\theta$  is much larger than  $0.3\text{g}$  of PGA, which a simpler-minded fragility function might have assumed.

**Fragility of freestanding monitors and televisions.** These slender items often rest on a relatively narrow base, with an aspect ratio (height to width) of 3:1. The project team therefore used the rigid-block fragility function described above with  $\alpha = \arctan(0.33)$ .

**Consequences of water heaters overturning.** It seems reasonable to assume that an overturned water heater would be replaced, at a current cost of approximately \$1,000. Furthermore, if a water heater overturns, it can rupture the gas line, providing fuel for a fire, and its pilot light can provide a nearby ignition source, lighting the fire. The fire can burn a portion of the building, the entire building, or many buildings.

Recall that Williamson (2000) estimates 0.84% of overturned water heaters ignite fires. Scawthorn et al. (1998) suggest \$270,000 of property damage per ignition in an earthquake in which engines outnumber fires, whereas Scawthorn (2018) estimates \$45 million in property loss per ignition in a large earthquake in which ignitions outnumber fires—a difference of more than two orders of magnitude ( $\log_{10}(\$45,000,000/\$270,000) = 2.2$ ). It is beyond the capacity of the present study to estimate risk on the basis of how many big earthquakes occur and how many small earthquakes occur, and how each of many sizes of earthquake contribute to overall risk. For present purposes, the project team uses the geometric mean of these two endpoints:  $(270,000 \times 45,000,000)^{0.5} = \$3,500,000$  in property loss per ignition, that is, \$270,000 times  $10^{1.1}$ .

Property losses can be divided among building and contents using common homeowner insurance policy provisions: about \$0.55 of building and ancillary structures coverage and \$0.35 of content coverage per \$1.00 of homeowner policy coverage. The remaining \$0.10 is additional living expense.



## NATURAL HAZARD MITIGATION SAVES:

To estimate fire-related deaths and nonfatal injuries, as elsewhere in this study, the project team reviewed U.S. fire statistics for the period 2003-2015 (USFA 2018). In that period, on average, there were 0.27 fatalities and 1.39 nonfatal injuries per million dollars of property loss. For purposes of assigning an acceptable cost to avoid a statistical nonfatal injury, the nonfatal fire injuries are treated here as if they were all Hazus injury severity level 2, that is, emergency department treat and release. Instances of post-traumatic stress disorder are taken as equal to the number of nonfatal injuries.

The total loss given to hot water overturning therefore can be taken as the property loss given that a water heater overturns and does not ignite (99.16% probability, \$1000 replacement cost of the hot water heater) or that it overturns and does ignite (0.84% probability, and all the property loss and life-safety consequences listed above). The expected value of loss in the event of a water heater overturning is approximately \$53,000.

Finally, recall that virtually all water heaters in California are required to be braced to the building frame, as has been the case since 1982, but that 2,500 water heaters overturned in the 1994 Northridge earthquake. Despite the 1982 law, guidelines for how to strap water heaters were not issued until 1992 (Stone, 1999), which may explain why many heaters were not secured by 1994.

*Consequences of bookcases overturning.* People get hurt when bookcases and other large items fall on them. FEMA P-58 PACT suggests that being struck by a large falling object can result in serious injury or death, but offers little guidance on the degrees and probabilities. In the present work, the project team observed that nonstructural damage in past earthquakes tended to injure and not kill people; the team divided the injuries in proportion to injuries treated by medical personnel in the 1994 Northridge earthquake. See Figure 4-8, which suggests 16,400 injuries of Hazus severity 1 and 8,200 of Hazus severity 2, with very smaller rates of Hazus severity 3, neglected here for simplicity. Thus, injuries were modeled here as  $2/3^{\text{rds}}$  severity-1 injuries and  $1/3^{\text{rd}}$  severity-2 injuries. Note that overturning bookcases *can* kill: Reed (1986) and Dotinga (2010) report one fatality in the July 13, 1986 Oceanside, California earthquake, when an 87-year-old man was buried for 11 hours under thousands of books. However, the probability of death from overturning bookcases seems low enough to neglect without biasing the benefit-cost ratio excessively low.

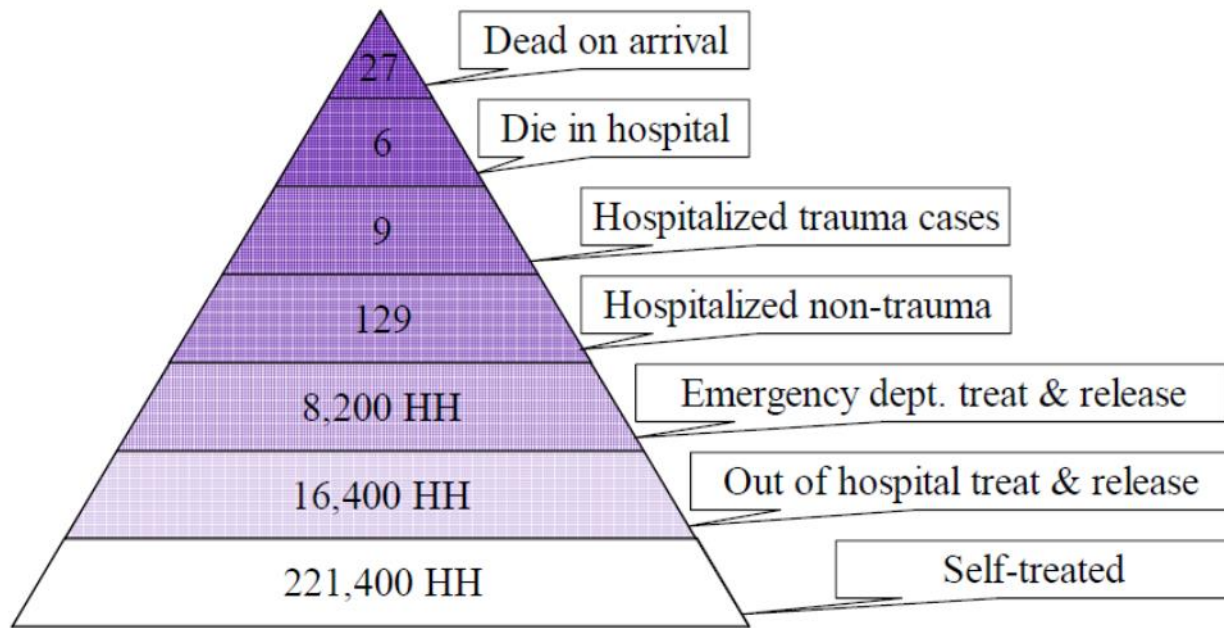

**Figure 4-8:** Northridge Earthquake injuries. “HH” indicates number of households in which at least one person experienced this level of injury (Porter et al. 2005 after Seligson and Shoaf 2003).

FEMA P-58 PACT recommends that each bookcase threatens occupants within 20 sf of floor area. The project team estimates that the average person occupies the home about 12 hours per day and that the average home has two freestanding bookcases. So if people are uniformly distributed around a house of area 600 sf to 1000 sf per occupant, the expected value of the number of people struck given that bookcases overturn is  $2 \text{ bookcases} / \text{household} \times 20 \text{ sf/bookcase} \times 1 \text{ occupant} / 800 \text{ sf} \times 12 \text{ hours of occupancy} / 24 \text{ hours per day} = 0.025 \text{ injuries per household}$ . The project team divides injuries between Hazus injury severity levels 1 and 2 in proportion to treated injuries in 1994 Northridge Earthquake (Porter et al. 2005).

**Fragility functions and consequence functions used here.** The measures considered here are those that a homeowner or tenant conceivably could perform without help, so the project team treats the cost as just the cost of the materials, which can be estimated from online catalogs like Amazon. Table 4-6 lists a subset of items in the Earthquake Country Alliance’s list: those common to homes, commonly appear to be damaged in earthquakes, result in a financial loss or injury if damage occurs, and are relatively straightforward for a homeowner or tenant to remediate. A few elements that are distinct in the Earthquake Country Alliance’s list are combined in the table here for convenience and simplicity.

The table lists the items in the first column. The second column provides a reference to the fragility functions as identified in FEMA P-58 PACT (Applied Technology Council 2012). The third column describes the PACT damage state. The fourth column provides the present project team’s estimate of a common quantity of such items in a home. The fifth column provides the PACT fragility function parameters. The sixth column provides the expected value of the consequences of the damage state occurring. The project

## NATURAL HAZARD MITIGATION SAVES:

team assigned dollar values to consequences largely based on its own judgment (PACT does not offer dollar values). The last column provides the material cost of remediation and homeowner or tenant effort. For purposes of benefit-cost analysis, homeowner or tenant effort is valued at IndependentSector.org's value of volunteer time, currently \$24.69 per hour.

It is assumed here that remediation mostly prevents damage. While damage still can occur to the remediated item, the project team assumes that the damage is so greatly reduced that any remaining damage represents statistical noise compared with the uncertainty in the model of damage to the unremediated item, and therefore can be ignored.

**Table 4-6:** Residential retrofit measures and parameter values

Element	PACT ID	Damage	Quantity	IM, fragility parameters	Consequence	Remediation and cost	Life (yr)
Water heater	None	Overturns	1	PGA, $\theta = 0.29g$ , $\beta = 0.5$	\$50,000	Strap to building frame, \$20 + 2 hr labor	10
Kitchen cabinets	E2022.013	Doors open, contents fall out	14 doors	PGA, $\theta = 0.25g$ , $\beta = 0.5$	\$1,850 to replace broken china & glasses + 4 hr labor	Child-proof latches, \$14 + 2 hr labor	50
Bookcases, shelving, and display cases	E2022.104a	Overturns	2	PGA, $\theta = 0.14g^{(a)}$ , $\beta = 0.5$	Hazus level-1 injury with probability 0.077 and level 2 with probability 0.0083	Furniture safety straps, \$20 + 2 hr labor	9
Monitors and TVs	None	Overturns	2 monitors or TVs	PGA, $\theta = 0.33g$ PGA, $\beta = 0.50$	\$1,000 to replace broken monitors + 1 hr cleanup labor	TV safety straps, \$16 + 1 hr labor	9
Fragile objects on shelves or in display cases	E2022.013	Falls and breaks	10 fragile items	PGA, $\theta = 0.25g$ , $\beta = 0.5$	\$1,000 to replace broken items + 4 hr cleanup labor	Museum putty, \$10 + 1 hr labor	9

- (a) PACT suggests PGV with  $\theta = 14$  cm/sec. Approximated using  $PGA = 0.14g$ , based on Boore et al. (2014) ground motion prediction equations for  $M_w$  6.5 earthquake at 25 km distance,  $V_{s30} = 315$  m/sec, 300 m depth to 1000 m/sec rock.

### 4.6.4. Selection and Analysis of WUI Fire Retrofit of Private-Sector Buildings

The dominant option for retrofitting private-sector buildings to better resist fire in the wildland-urban interface is to retrofit them to comply with the 2018 International Wildland-Urban Interface Code. No other option was considered here.

## 4.7. IDENTIFYING THE IEMAX LEVEL OF ADDITIONAL MITIGATION

The selected options to exceed I-Code requirements for flood, wind, and earthquake each offer a range of design levels. For example, one can design new buildings to be a little higher above BFE or a lot higher. Under standard BCA procedures, the IEMax level of investment requires that both the total benefit exceeds the total cost and the incremental benefit exceeds the incremental cost. For example, suppose one could choose to build new buildings in coastal velocity zones (V-zones) 1 foot above BFE, 2 feet, 3 feet, 4 feet, etc.

The IEMax level of additional mitigation is the point on a geographic and mathematical basis where the last incremental improvement in the design cost effectively captures the last incremental benefit. One of the most widely cited texts on engineering economic analysis (Newnan et al. 2006, p. 503) uses the term “best alternative” defined to be the “maximum investment such that each ratio of equivalent worth of incremental benefits to equivalent worth of incremental costs is greater than 1.0.” The present analysis uses IEMax to avoid the word “best,” recognizing that significant benefits can be achieved cost effectively at various levels of design up to the IEMax, meaning that one can enjoy cost-effective improvement without designing all the way up to the IEMax level.

Suppose it is cost effective to build 2, 3, or 4 feet above BFE on a benefit-cost basis. That is, the total benefit exceeds the total cost for each of those elevations. In each case, it costs more to build  $n + 1$  feet above BFE than  $n$  feet, and there may be an additional benefit as well. The analyst must estimate whether the additional benefit of the additional foot—increasing from  $n$  feet to  $n + 1$  feet—exceeds the additional cost, that is, whether the last foot of additional elevation is cost effective.

Figure 4-9 illustrates the concept: each dot represents one possible level of design to exceed code requirements: “2” means BFE plus 2 feet, “3” means BFE plus 3 feet, etc. Each dot has a cost (its  $x$ -value) and a benefit (its  $y$ -value).  $\Delta C$  denotes the incremental cost of building  $n + 1$  feet rather than  $n$  feet above BFE, and  $\Delta B$  denotes the incremental benefit. One can say that the IEMax investment is the last value of  $n + 1$  for which  $\Delta B$  is greater than  $\Delta C$ , or in other words,  $\Delta B/\Delta C > 1$ .

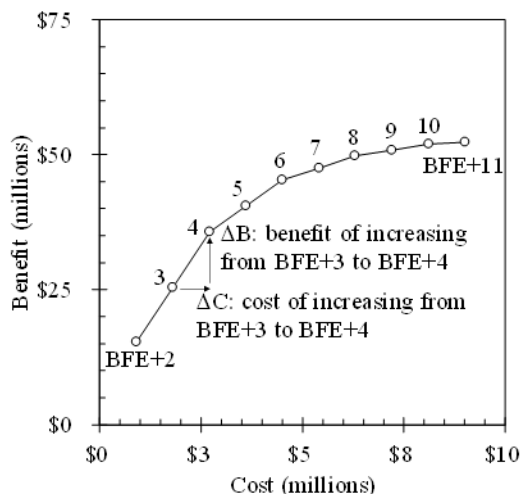

Figure 4-9: Incremental benefits and costs when evaluating a range of possible degrees of mitigation investment.

## 4.8. BCA OF FEDERAL MITIGATION GRANTS

This section describes the BCA of federal mitigation grants studied in this project. The analysis involves three major steps. In Step 1, a stratified sample of mitigation grants is created. A stratified sample consists of individual grants selected according to hazard (earthquake, wind, flood, and fire) and mitigation types (project and process activities). In Step 2, the BCR for an individual project within a stratum is calculated. In Step 3, the benefits and costs from the sample are scaled up to the entire population of project and process activities, as described in the previous section.

## 4.9. GRANT SAMPLING STRATEGY

This section only applies to the study of federally funded mitigation grants, not design to exceed I-Code requirements. Recall that Step 1 in Section 4.1 required selecting a sample mitigation measure. The population of all grants is first stratified (grouped) by peril. Thus, one such stratum (or group) contains only flood-related mitigation projects. Another contains only mitigation activities related to hurricane winds. The reason for stratifying in this way is that BCRs may differ among these broad categories of mitigation grants, and it is desirable to ensure that several activities in each stratum are represented in the sample. Activities within a stratum do not contribute equally either to total benefit or to total cost. It is likely that a small number of costly activities dominate both cost and benefit.

To ensure reasonable results, this fact should be reflected in the sample. Furthermore, it is desirable that activities of all cost levels are present in the sample. Therefore, mitigation activities within each stratum are sorted by cost. They are binned (grouped in batches of similar total cost) so that the total cost of each bin is approximately equal. Thus, one bin contains a few high-cost projects, another contains many lower-cost mitigation activities. One mitigation activity is then selected at random from each bin. As a result, the

sample contains more grants for high-cost mitigation activities than for low-cost ones, and yet still contains at least some grants for low- and medium-cost activities. Mathematical tests performed in the 2005 *Mitigation Saves* study confirm that this approach produces more accurate estimates for the population benefit with less uncertainty than any of several competing alternatives.

**Figure 4-10** illustrates the sampling scheme. The red highlighted layer (flood, project, high) defines one stratum within the entire population of all grants. A sample of  $N$  projects from the stratum are desired for detailed BCA. First, all the projects in the stratum are sorted by project cost. The projects are grouped in bins. (In the figure, the bins are represented by the stacked boxes on the right and each project is represented by an "o" in the bins.) The first bin (the top one in the upper right of the figure) contains the  $x$  most-costly projects, the sum of their costs equaling approximately  $1/N$  times the sum of all project costs in the stratum. In the second box,  $x=3$ , that is, the next three most-costly grants contribute approximately  $1/N$  times the sum of all project costs in the stratum. The project team selected one of these three at random for detailed BCA. (The selected grant is indicated by the red circle.) In the same manner, the figure shows that that the next most-costly five grants also cost approximately  $1/N$  times the sum of all project costs in the stratum. The project team selected one of these five at random for detailed analysis. And so on.

### **Box 4-1. The Impact of Sampling Strategy on Cost-Effectiveness**

The 2005 *Mitigation Saves* study considered the approach outlined in Section 4.6 and three others, such as randomly sampling grants with equal probability of picking any grant, regardless of cost. The sampling strategy used here results in the least difference between sample-average BCR and that of the population. It also results in the smallest standard error  $s$  in Equation 4-8, e.g., the smallest uncertainty where the true population BCR lies relative to the sample average. Both facts are important because the project's ultimate goal is to estimate the probability that mitigation is cost-effective, e.g., whether the true, population-wide BCR  $> 1$ , as shown in Equation 4-10.

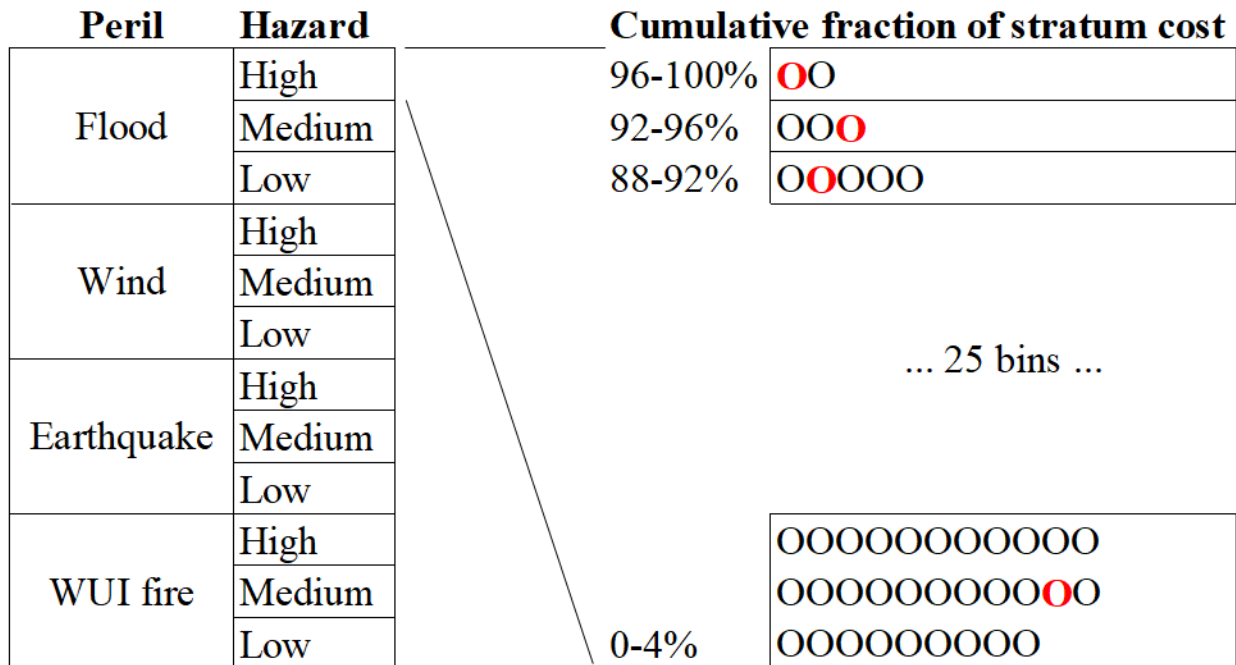

Figure 4-10: Stratified sampling scheme for federal mitigation grants.

#### 4.10. NOTES ON RIVERINE FLOOD METHODOLOGY

The project team used different methods to estimate the benefits and costs to mitigate the four perils examined here. In some cases, the project team used Hazus largely as-is. This section presents some details on the largely Hazus-based methodology for estimating benefits and costs of mitigating riverine flooding. See later sections of this chapter for other details, including flood hazard, vulnerability, loss categories, calculation of benefits, and calculation of the BCR.

Figure 4-11 depicts the approach the project team applied to estimate the benefits and costs of exceeding I-Code requirements. The approach seeks to identify elements that were both consistent across geographic locations as well as those that were likely to be more regionally or locally unique. As shown in the figure, the methodology calculated BCR values for elevating single-family homes above I-Code requirements. The effectiveness was determined by calculating the ratio of the amount of saving resulting from the loss avoided due to the elevation of a single-family dwelling (e.g., benefits), to the costs encountered in elevating the dwelling.

Hazus was used to assess building and content losses of single-family homes before and after elevation, as well as to estimate the economic impacts of the elevation activity on the census block in which these homes are located. The Interim Study modeled these impacts both for as-is circumstances reflective of the current built environment in the sample communities, as well as for new construction of single-family dwellings exceeding 2015 I-Code requirements. Benefits were calculated in terms of the amount of loss avoided by elevating new single-family homes to a particular x foot above I-Code requirements at the

## NATURAL HAZARD MITIGATION SAVES:

same location of the existing homes. The analysis resulted in estimates of a BCR per additional  $x$  foot of elevation, accounting not only for building losses but also losses resulting from BI and social impacts resulting from elevating single-family homes as described elsewhere in the Interim Study.

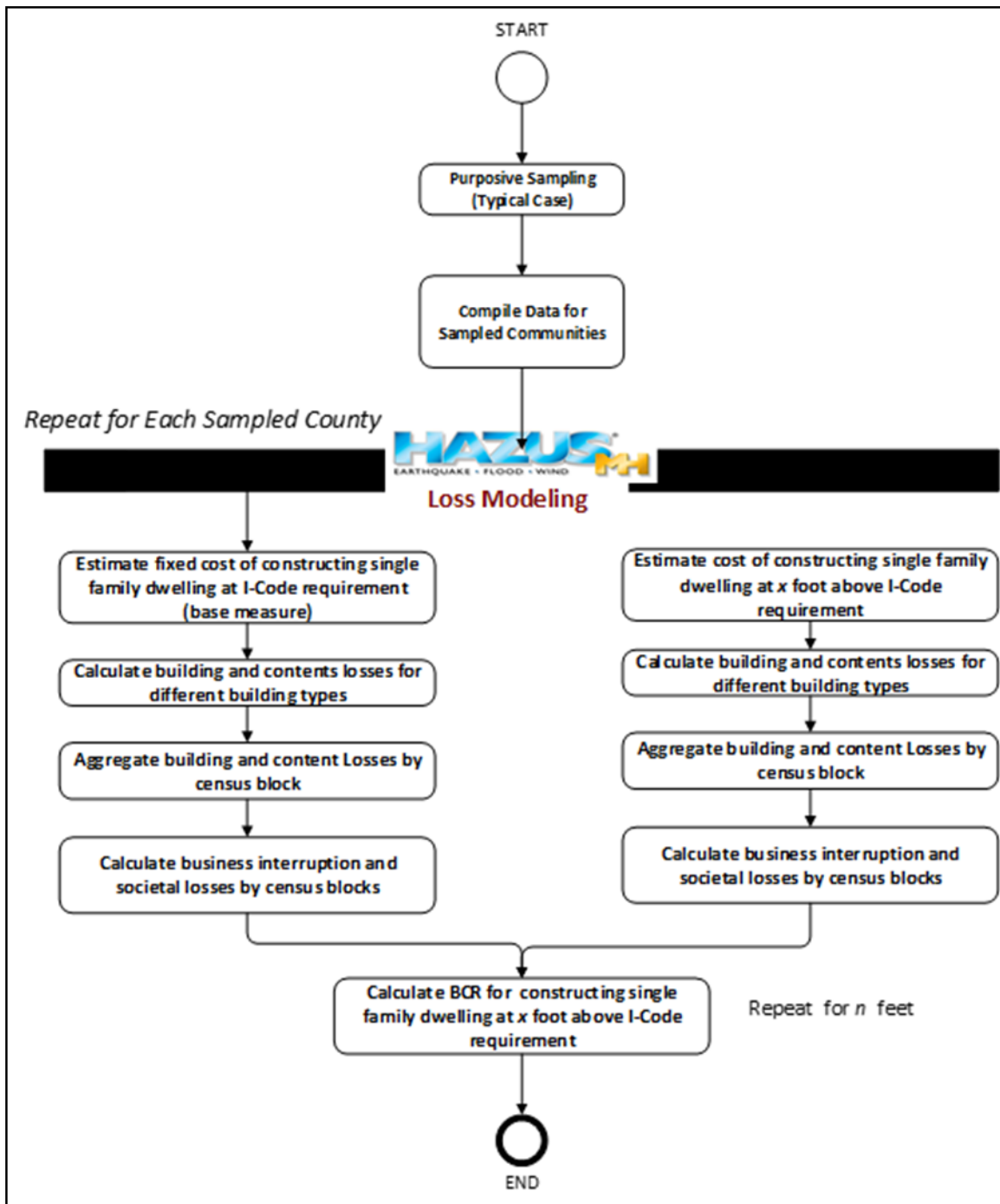

Figure 4-11: Methodology to estimate BCR for designs exceeding I-Code requirements for riverine flood.



## NATURAL HAZARD MITIGATION SAVES:

**Costs.** The cost of constructing a new single-family residential dwelling an additional  $x$  feet above that required by the 2015 I-Codes is calculated using Equation 4-17.

$$C(x) = \alpha + \beta \times x + \tau \times x$$

Equation 4-17

Where,

$\alpha$  = fixed cost of elevating a residential structure of a given type and area

$\beta$  = incremental cost of elevating a structure of a given type by an additional foot

$\tau$  = cost to comply with the Americans with Disabilities Act of 1990 (ADA) for each additional foot of elevation

Equation 4-17 is an approximation. It attempts to capture all significant cost components, but costs may vary between communities. The equation may omit some costs such as code enforcement, if designing to exceed I-Code requirements involves any additional enforcement cost.

Figure 4-12 summarizes the project team's approach to estimating the effectiveness of federal mitigation grants directed to acquisitions of flood-prone structures. As in the analysis of designing to exceed I-Code requirements, the Interim Study used a geographic information system (GIS) with Hazus.

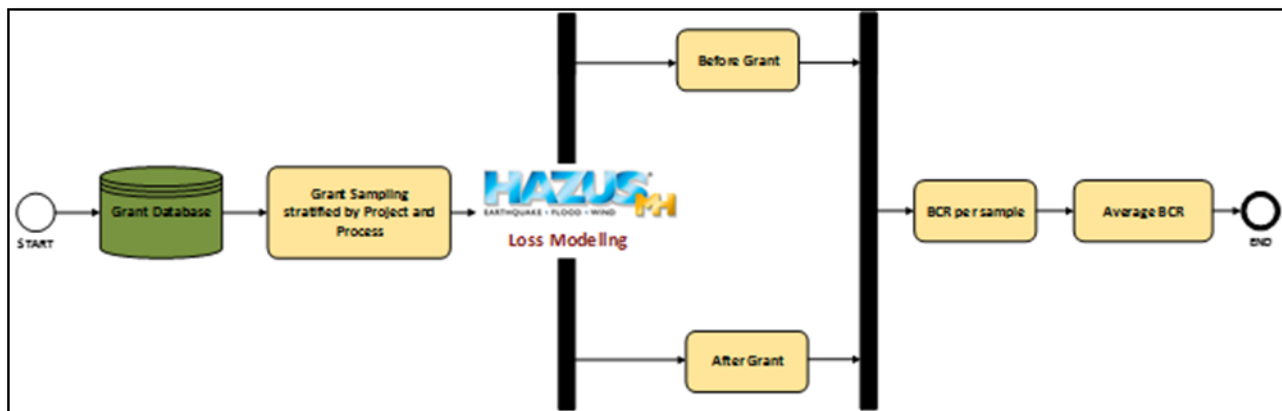

Figure 4-12: Use of Hazus to estimate benefits and costs of federal grants for riverine flood.

## 4.11. ESTIMATING EXPOSURE

### 4.11.1. Present Day Exposure

Exposure here refers to the engineering characteristics of the assets at risk: the buildings, utilities, and transportation infrastructure one might enhance with natural hazard mitigation. Engineering characteristics include geographic location, use, structural system, replacement cost, year built, and others.

## NATURAL HAZARD MITIGATION SAVES:

Grant applications contain most or all of the necessary exposure data for mitigation projects funded by FEMA, EDA, etc. To estimate the costs and benefits of designing to exceed I-Code requirements, one must first estimate the quantity of buildings exposed to natural hazard loss by geographic region, occupancy class, building type, and time of day. Table 4-7 lists several options for how to estimate exposure including the advantages and disadvantages of each. For designing to exceed I-Code requirements for earthquake, the project team used the Hazus inventory created for USGS PAGER, updated to October 1, 2016. For flood and wind, which do not require a nationwide inventory, the project team used superior site-specific information.

**Table 4-7:** Options for exposure data.

Option	Advantages	Disadvantages	Comments
Hazus	Well documented, nationwide scope, fairly authoritative, nationwide inventory tabulated for USGS PAGER project in 2008	2008 data are based on 2002 Hazus data; estimated from proxies of population and employment data	Can approximate growth since 2002 based on state population growth and construction cost indices to account for the increase in square-foot construction costs since 2002.
Population alone	2015 estimates available	No commercial, industrial, government, nonprofit.	
Tax assessor files	Actual enumeration of taxable property	No central resource; costly; diverse formats; often inconsistent valuation procedures; often lacks required parameters	1111 Broadway, Oakland lacks material, LFRS, height, year built, floor area, building replacement cost new, occupants...
OpenStreetMap	Free and detailed outlines of building footprints contributed by the open GIS community. Spatially accurate	Sparse attributes, typically incomplete or not fit for purpose	Appropriate for disaggregating census data or for sampling possible locations when assessing detailed hazards, such as coastal surge or flood
Remote sensing	Efficient use of remote sensing can be used as a stratified sampling technique to apply engineering expertise or observations to an existing hazard data source, such as Hazus,	Remote sensing technologies require subject matter experts.	Useful when there are limited or broad regional assumptions in mapping occupancy to structural type as well as occupancy to assumed "model building type" for estimating replacement cost.

## NATURAL HAZARD MITIGATION SAVES:

	and increase the accuracy of replacement cost and vulnerability assumptions.		
--	--	--	--

Hazus offers the relevant aspects of its U.S. building-stock inventory in a normalized database of 15 tables for each state. To make use of these normalized data, in 2008 Porter compiled the data into a single denormalized table, one table for each state and the District of Columbia (a total of 51 tables). Each table contains one record (one row) for each unique combination of U.S. Census tract, Hazus model building type, code level, and Hazus occupancy classification. For each combination, the inventory provides the Hazus default estimate of total building area in square feet, number of occupants at three times of day (2 PM, 5 PM, and 2 AM), building replacement cost (new), and content replacement cost (new).

Census tract was the smallest practical geographic unit of deaggregation for the earthquake risk analysis, owing to limits in file size in Microsoft Access, which was used to create the inventory. (Analyses for other perils such as riverine flood are performed at a census-block or other level. That level of detail is impractical for the earthquake risk analysis, which deals with many combinations of model building type and occupancy class in each census area.) U.S. Census tracts generally have a population size between 1,200 and 8,000 people, with an optimum size of 4,000 people. They can be geographically large or small depending on population density. Greater population density means smaller tracts. Miami-Dade County, Florida, for example contains 360 tracts with an average area of approximately 14 square kilometers (U.S. Census Bureau 2010). Figure 4-13 shows the size of a census tract in downtown Oakland, California. The blue lines delimit census tracts. The tract with a blue dot in it contains approximately 32 city blocks. The blue dot represents the geographic center (called the centroid) of the tract. If one treats all the people and property in the tract as if they were all at the centroid, one sacrifices little accuracy in estimating seismic hazard, because the centroid is on average less than 250 meters from any given building in the tract. In suburban and rural communities, the distance is greater, but the value exposed is also lower and the error contributes less to the estimate of societal risk. The usefulness of census-tract-level information varies by peril: it is most useful for earthquake and perhaps tornado, least useful for riverine and coastal flood.

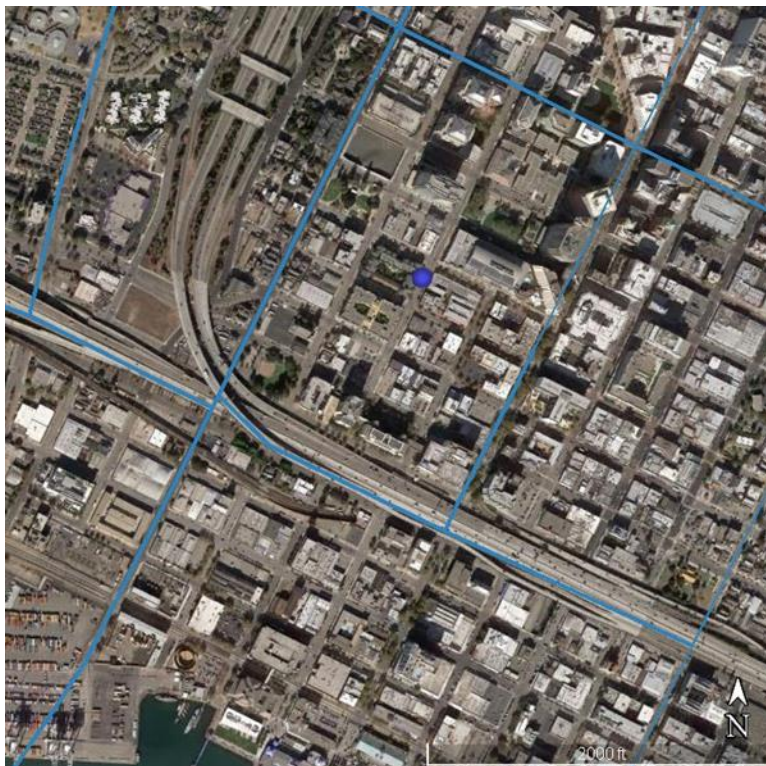

Figure 4-13: Census tracts near downtown Oakland, California.

WUI exposure has been mapped for the conterminous United States at the census block level (Martinuzzi et al., 2015a, 2015b). This dataset provides information on housing units and population in each census block and is the basis for analysis of assets at risk. Analysis of all census blocks in the conterminous United States was computationally infeasible, so the project team did analysis at the census block level for four counties (population in millions in parentheses): Los Angeles County, California (10.12), Alameda County, California (1.61), Ada County, Idaho (0.43), and Atlantic County, New Jersey (0.28). These four counties were selected as spanning the range of WUI fire hazard severity—Ada County has some of the highest BPs in the entire nation, parts of Los Angeles County are also high fire hazard with a very large population, Alameda County similarly is at high risk and was the site of the 1991 East Bay Hills fire, perhaps the largest WUI fire loss in modern history; Atlantic County is more typical of moderate fire hazard in the eastern United States.

The project team analyzed one single-family dwelling prototype in each census block (e.g., all housing units in the WUI are assumed to be this prototype). The project team recognized that there are many other buildings and physical assets at risk within the WUI, beyond the single-family dwelling prototype—not even all housing units are single-family dwellings. However, the analysis is confined to this one prototype because 1) nationwide, it is by far the most prevalent building type within the WUI; 2) many other building types in the WUI (e.g., small stores, offices, places of business in general, commercial strip malls, schools and places of assembly) are often of wood frame construction, and do not differ significantly from the prototype with regard to fire vulnerability; 3) even non-combustible construction when subjected

to WUI fire attack, if undefended, will, in most cases, burn to destruction; 4) the focus of the IWUIC is clearly on wood frame construction, for which the prototype is the most common example. Beyond buildings, other assets in the WUI fall broadly into two categories: 1) human-made, such as roads, bridges, tunnels, airports, utilities, larger infrastructure such as electric transmission facilities, water supply reservoirs, etc. None of these are the subject of the IWUIC, and their consideration is beyond the scope of this project; 2) natural environmental assets, including flora and fauna. While of enormous value, again these are not impacted by the 2015 IWUIC and their consideration is beyond the scope of this project.

Hazus model building types for earthquake risk analysis are listed in FEMA (Federal Emergency Management Agency 2012) Table 5.1, among other places. Model building types generally classify buildings by structural material (mostly wood, reinforced concrete, steel, or masonry), lateral force resisting system (generally shearwall, frame, or bearing wall), and height class (1-3 stories, 4-7 stories, or 8+ stories). Hazus classifies a building as having one of four code levels: pre-code, low code, moderate code, or high code, generally referring to the degree to which the code in force at the time of construction specified sufficient lateral strength and structural detailing requirements to ensure a complete load path, among other goals. Hazus also allows for three more classes of special construction, called “above-code” in Federal Emergency Management Agency (2012e) but more accurately referring to buildings that would have been built according to code requirements for hazardous or essential facilities (Risk Category III or IV, in the terminology of the American Society of Civil Engineers Structural Engineering Institute [2010]). See Federal Emergency Management Agency (2012e) Table 15.1 for Hazus occupancy classes; it lists 33 classes, generally subcategories of residential, commercial, industrial, agriculture, religion, government, and education.

The 51 inventory tables (one for each state plus the District of Columbia) were originally compiled in 2008 and reflect the inventory that the Hazus developers provided in 2002. The population has grown since 2002 and construction prices have increased. One can reflect these increases as follows: Factor square footage and number of occupants by a population growth factor  $F_1$  to account for population growth on a state-by-state basis from January 2002 to October 2016 (the date of the beginning of the present project). See Equation 4-18. Factor building and contents replacement costs by both the population growth factor  $F_1$  and a factor  $F_2$  to account for both population growth and the increase in per-square-foot construction costs over time. See Equation 4-19. In the equations,  $P(\text{year})$  denotes the USCB’s population estimate as of the stated year (U.S. Census Bureau 2004). The factor 14.75/13 is used to linearly extrapolate from January 1, 2002 to October 1, 2016. The term  $C(\text{year})$  denotes RSMean’s 2015 national 30-city average historical city cost index (CCI) as of the stated year. Its national 30-city CCI reflects an estimate of the nationwide average growth in construction costs (RSMean’s n.d.).

$$F_1 = \frac{P(2015)}{P(2002)} \cdot \frac{14.75}{13.00}$$

Equation 4-18

$$F_2 = \frac{C(2015)}{C(2002)} \cdot \frac{14.75}{13.00}$$

Equation 4-19

Recall that the inventory of buildings representing code-compliant design is to be modeled as if designed to the 2015 IBC, but using each state's local mix of lateral force resisting systems, building heights categories, and occupancy classes. To reflect that mix, the project team modeled the code-compliant inventory in each state using the distribution of the most recent construction as reflected by the highest code level in that state's inventory. In cases where even that most-recent design level includes obsolete building types such as unreinforced masonry (URM) bearing walls, one can change obsolete types to similar but non-obsolete types. For example, the project team changed all mid-rise URM bearing wall buildings to high-code reinforced masonry buildings with rigid diaphragms. To reflect designing to exceed 2015 I-Code requirements, the analysis uses the same mix of structural systems, heights, and occupancies, but with greater strength and stiffness, as discussed later.

Content and stock damage are also modeled, because their damage will be affected by the designing to exceed I-Code requirements. Their replacement-cost values are estimated as a factor of building replacement cost, using the same factors assumed by the Hazus developers.

Note that for purposes of evaluating benefits of designing to exceed I-Code requirements, the project team mapped BCR on a geographic basis (e.g.,  $b_i/c_i$  of Equation 4-7), e.g., without multiplying by total expenditures ( $E_i$  in Equation 4-3). The exposed values, their geographic locations, and their change over time only matter when one estimates the aggregate benefits and costs ( $B$  and  $C$  of Equation 4-6). The method to project population growth and spread is discussed next.

### 4.11.2. Creating a Proxy Portfolio for Designing to Exceed I-Code Requirements for Riverine Flood

The project team used a purposive sampling technique of typical cases of communities that represent common floodplain conditions and residential structures found in riverine flooding across the United States. The word *typical* here implies that the results and conclusions are illustrative for all communities in the United States that meet the characteristics of the urban and rural communities analyzed in the Interim Study.

The decision to apply a purposive sampling approach to select target communities was justified by the following:

- The existence of a relatively small number of geographic areas (sample areas) where detailed data are available and where the built environment is diverse enough to allow for the exploration of various elevation scenarios; and

## NATURAL HAZARD MITIGATION SAVES:

- A recognition that both the nature of the analysis performed in the Interim Study and the generated benefit and cost functions per foot of elevation require close consideration for specific flood events in specific communities.
- Use of a regression model to generalize results of the analysis to similar characteristics across the United States (see Section 2.2.1 of the Interim Study).

The selection of sample communities was based on a number of different factors. Among these were:

- House size
- Foundation types: open (crawlspace/pier foundation) versus closed (slabs)
- Construction cost
- Flood hazard conditions (1% versus 0.2% annual chance of flooding)

The following parameters likely matter most to the cost effectiveness of designing to exceed I-Code requirements for riverine flood:

- Footprint area
- Number of stories
- Foundation type (piers or piles, open or closed)

The project team evaluated the cost effectiveness of designing to exceed I-Code requirements for riverine flood for four building sizes (Table 4-8), six foundation types and five elevations (Table 4-9), and four geographic regions (Figure 4-14). The four regions were Monroe and Fulton Counties in Georgia, and Elkhart and Allen Counties in Indiana. Monroe County is rural, while the rest are pronominally urban. All the buildings are single-family dwellings (RES1 in Hazus nomenclature). The four counties have different distributions of house size (in terms of stories and total floor area) and foundation type (open or closed), as summarized in Table 4-10. All the houses are located in the 500-year (0.2% probability per year) flood area. Only rural Monroe County, Georgia has open-foundation houses in the 0.2% annual chance flood area; houses in the 0.2% annual chance flood area in the more-urban counties all have closed foundations. Section 2.2.1 further presents regression models the project team developed to generalize the results of the analysis.

**Table 4-8:** Four building sizes used to determine BCRs for riverine flood.

Building size	Length (ft)	Width (ft)	Stories	Footprint (sf)	Floor area (sf)
1	50	30	1	1,500	1,500
2	50	30	2	1,500	3,000
3	60	40	1	2,400	2,400
4	60	40	2	2,400	4,800

## NATURAL HAZARD MITIGATION SAVES:

**Table 4-9:** Foundation and elevations used to determine BCRs for riverine flood.

Flood hazard zone	Foundation types	Lowest floor elevation (ft)
A	Timber pile	BFE +1
	Concrete pile	BFE +2
	Masonry pier	BFE +3
	8" masonry pier	BFE +4
	12" masonry pier	BFE + 5
	Fill and slab-on-grade	



**Figure 4-14:** Locations used to determine BCRs for riverine flood.

**Table 4-10:** Portfolio of foundation type (open or closed) and house size (stories and total area) by county, used to determine BCRs for riverine flood.

County	Open foundation				Closed foundation			
	1 story 1500 sf	2 story 3000 sf	1 story 2400 sf	2 story 4800 sf	1 story 1500 sf	2 story 3000 sf	1 story 2400 sf	2 story 4800 sf
Allen, IN	0	0	0	0	97	49	41	6
Elkhart, IN	0	0	0	0	82	59	223	48
Fulton, GA	0	0	0	0	195	161	99	168
Monroe, GA	15	6	9	2	1	0	1	0

**Workflow.** The project team applied a GIS to carry out the following analytical steps. (The steps mix the tasks of developing a sample inventory and characterizing hazards.)



## NATURAL HAZARD MITIGATION SAVES:

**Step 1:** Develop depth grids. The project team used Hazus to generate two depth grids: one grid showing depths at each grid point in each county with a 1% exceedance probability in 1 year (100-year MRI) and another showing depths with 0.2% exceedance probability in 1 year (500-year MRI). Recall that the 2015 I-Codes require the first floor elevation be at least BFE + 1, e.g., 1 foot above the depth with 100-year MRI.

**Step 2:** Classify depth grids based on water level. The project team classified depth grids for the 1% annual chance and 0.2% annual chance year return periods developed in Step 1 based on water level (e.g., flood inundation level). The classification resulted in two zone categories: shallow water or deep water. The project team classified cells with depth less than the median as lying in the shallow-water zone, labeled “zone 1” for brevity. The team classified cells having depth greater than the median as lying in the deep-water zone, or “zone 2” for short.

**Step 3:** Create a proxy building inventory based on the real building stock. Each house in the real building stock of the four sample counties is unique. To make the BCA tractable, the project team simplified the real building stock by imagining that new buildings of a limited number of designs were to be built in place of the existing ones in the 1% annual chance flood plain. Every building in the real inventory was mapped to its closest approximation in Table 4-8, first considering number of stories, then by nearest total square footage. For example, if an actual single-family dwelling had 1 story, it was mapped to either size 1 or 3, e.g., either a 1-story, 1,500-square-foot house or a 1-story, 2,400-square-foot house. If the real house had a total floor area of 1,450 square feet, it was mapped to (in a sense, replaced by) the 1-story, 1,500-square-foot house (size 1 in Table 4-8), for purposes of BCA. That is, the project team estimated benefits and costs for a new size-1 house built at the location of the real house.

**Step 4:** Assign foundation types to the proxy building inventory. The project team assigned each building in the proxy portfolio to one of two foundation types: open or closed, based on which Hazus foundations type the real building has, as shown in Table 4-11. With four building sizes and two foundation types among the proxy buildings, each real building maps to one of 8 models, labeled A through H, as shown in Table 4-12.

**Step 5:** Associate each house with a grid cell and thus a depth zone: shallow (zone 1) or deep (zone 2). With four possible building sizes, two possible foundation types, and two possible depth zones, the project team mapped each real house in the four sample counties to one of 16 cases, that is, combinations of size, foundation type, and depth zone, listed in Table 4-13.

**Step 6:** The project team used 16 different cases shown in Table 4-13 to randomly stratify census blocks in the four sample counties to model the effectiveness of building new single-family dwellings to greater elevation. The team selected these census blocks by first determining the dominant building classification in each census block; and second by ensuring that each of the four counties had as many as possible of the 16 cases represented.

**Step 7:** Update the Hazus GBS and Hazus UDF inventories. The project team updated the Hazus GBS inventory with all buildings located in the stratified census blocks. The project team updated the Hazus UDF inventory only with the single-family dwellings contained within the stratified census blocks. The project team used the Hazus GBS inventory to determine BI values within the impacted area considering all occupancy classes rather than just single-family dwellings (RES1). The team used the Hazus UDF inventory to derive all other impacts: building damage, content damage, etc. Table 4-14 provides the number of buildings included in the final dataset modeled for each case and county.

**Table 4-11:** Assigning foundation type to riverine flood proxy portfolio.

Real house has this foundation type	Proxy house was assigned this type
Crawl space	Closed
Basement	Closed
Slab	Closed
Pier	Open
Pile	Open
Fill	Closed
Wall	Closed

**Table 4-12:** Assigning model label to riverine flood proxy portfolio buildings based on size and foundation.

Model	Description
A	Size 1, open foundation
B	Size 1, closed foundation
C	Size 2, open
D	Size 2, closed
E	Size 3, open
F	Size 3, closed
G	Size 4, open
H	Size 4, closed

**Table 4-13:** Assigning a case identifier to riverine flood proxy portfolio buildings based on size, foundation, and depth.

Case	Description	Case	Description
A1	Size 1, open foundation, shallow	A2	Size 1, open foundation, deep
B1	Size 1, closed, shallow	B2	Size 1, closed, deep
C1	Size 2, open, shallow	C2	Size 2, open, deep
D1	Size 2, closed, shallow	D2	Size 2, closed, deep

## NATURAL HAZARD MITIGATION SAVES:

E1	Size 3, open, shallow	E2	Size 3, open, deep
F1	Size 3, closed, shallow	F2	Size 3, closed, deep
G1	Size 4, open, shallow	G2	Size 4, open, deep
H1	Size 4, closed, shallow	H2	Size 4, closed, deep

**Table 4-14:** Number of buildings by county and size-foundation-depth case in sampled census blocks of the riverine flood proxy portfolio.

Case	Number of Buildings			
	Monroe County, GA	Fulton County, GA	Elkhart County, IN	Allen County, IN
A1	33	0	0	0
B1	0	201	105	62
C1	16	0	0	0
D1	0	120	85	44
E1	10	0	0	0
F1	5	98	106	58
G1	0	0	0	0
H1	0	280	61	8
A2	9	0	0	0
B2	0	118	149	6
C2	10	0	0	0
D2	0	57	55	35
E2	13	0	0	0
F2	0	45	104	20
G2	9	0	0	0
H2	0	204	61	0
Total	105	1,123	726	233

### 4.11.3. Estimating Building Exposure for Riverine Flooding

To estimate the pre-mitigation building stock for regions subject to riverine flooding, particularly to analyze federal grants, the project team combined the Hazus GBS data with a UDF inventory. The UDF inventory was updated to represent the pre-mitigation location and conditions of the structures acquired by each grant. Where possible, the locations of these structures were based on the information in the grant database. However, in some cases, it was necessary to adjust these locations slightly because they either were not located in the Hazus generated depth grid or they were not located within one of the dasymetric census block boundaries.

When this adjustment was made, the project team moved the locations of the points as little as possible so that they fell within the 100-year flood inundation area and within a dasymetric census block boundary. In addition, the team chose the locations of moved structures to ensure that the depth of water in the 100-year flood exceeded the first-floor elevation of the building. The 1% annual chance event was selected because it was assumed that acquisitions were unlikely as a result of lesser flooding events.

To estimate post-mitigation building stock, the project team duplicated the pre-mitigation inventory, changing it to reflect the grant activity, e.g., by removing buildings acquired through the grant. Tables specifically modified included those reporting square footage, building count, dollar exposure and content exposure.

### 4.11.4. Estimating Building Exposure for Coastal Inundation

Coastal inundation presents a special problem for BCA, so a special approach is required to deal with it. The project team considered several options for constructing the building exposure database used to model the effects of designing new coastal buildings to exceed building code requirements for elevation. Each has advantages and disadvantages.

Typically, regional studies rely on census or regional data to approximate the building stock. Such an approach has a number of severe disadvantages. Exposure to storm surge changes throughout a coastal census tract or block with site elevation, coastal distance, and other local topographic and bathymetric features. Hazard can vary over distances of tens of meters, much smaller than a census tract, block group, or even census block, so building locations within the block or tract matter a lot. Coastal homes tend to be irregularly distributed within a block or tract, and are more likely to be clustered around streets that follow the coast, rather than close to the water on the beach. Census blocks extend past the coast, so an automated approach to estimating building locations based solely on census block boundaries and numbers of people or buildings in the census block is likely to estimate unrealistic building locations. One would likely estimate building locations as being in the surf, exaggerating the hazard and grossly under- or overestimating BCRs.

Local studies may use site-specific building data in the form of street addresses. While it can produce better accuracy than distributing building within census boundaries, geocoding addresses can also misrepresent building locations enough to matter to a BCA. Automated geocoding can result in estimated locations that are evenly offset (set back) from the street, but the true setbacks can differ significantly from a geocoding program's default setback, potentially by tens of meters, enough to produce large errors in hazard.

OpenStreetMap (OSM) offers a third option: building footprints (OpenStreetMap 2017). OSM building footprints allow sampling of actual site-specific building locations more accurately than geocoding and far more accurately than census data. Its disadvantage is that with greater accuracy comes greater computational burden. Weighing the advantage of accuracy against the computational burden, the

project team opted to estimate coastal building exposure using OSM building footprints, and dealt with the computational burden as described next.

Approximately 30,000 buildings from Texas to Maine intersect (lie within or touch) the FEMA NFIP V- or VE-zones (Federal Emergency Management Agency 2014d). For purposes of estimating the cost effectiveness of designing new buildings to exceed code requirements, imagine that new buildings are built to replace existing ones, always at the same location. A total of 30,000 buildings in V- and VE-zones were available for processing, though building footprints were not provided for every building. To make the problem computationally tractable, the project team randomly selected up to 1,000 building footprints per each of seven states, for a total of 7,000 locations. The project team extracted the latitude and longitude of the centroid of each of these 7,000 footprints and performed BCA for a new house located at that point.

### 4.11.5. Number of People and Households Based on Number of Buildings

In some cases (especially riverine flooding), the project team knew the number of residential buildings and needs to estimate number of occupants and number of households. The project team estimated number of occupants using Table 4-15. The table lists the residential occupancy classes examined for riverine flooding using the Hazus notation. With the number of occupants determined, the project team estimated number of households by dividing number of residential occupants by 2.5 people per household.

**Table 4-15:** Estimated building occupancy for riverine flooding.

Occupancy	Description	Number of occupants
RES1	Single-family dwelling	2.5 people per building
RES2	Manufactured housing	2.5 people per building
RES3A	Duplex	5 people per building

## 4.12. ESTIMATING HAZARD

In the present context, hazard refers to a relationship between environmental excitation and exceedance frequency in events per year. Environmental excitation refers to the forces or other loading conditions that the natural environment imposes on infrastructure. Table 4-16 lists hazard measures and sources. Details are provided in the following sections.

Table 4-16: Hazard measures and sources.

Peril	Measures, units	Source
Flood	Depth (A-zone), m Momentum flux (V-zone), m <sup>3</sup> /sec <sup>2</sup>	Hazus
Hurricane wind	10-meter 3-sec peak gust velocity (m/sec)	ASCE 7-16 <sup>(a)</sup>
Tornado wind	N/A. See Section 4.12.4	NWS
Storm surge	10-meter 3-sec peak gust velocity (m/sec)  MOMS (Maximum of MEOWs (Maximum Envelope of Water), Category 1-5, ft of surge height.  Projected sea level rise (cm) given GMSL scenario. Posted by tide gauge location.  Sea level rise on land given sea level rise, ft  Extent of "V" or "VE" zone.  Elevation, feet	ASCE 7-16 (American Society of Civil Engineers Structural Engineering Institute 2017)  NOAA 2013 SLOSH modeling (National Hurricane Center 2014)  NOAA Technical Report NOS CO-OPS 083 (Sweet, et al., 2017)  NOAA SLR Viewer (National Oceanic and Atmospheric Administration 2017)  FEMA Flood Maps (Federal Emergency Management Agency 2014d)  USGS (U.S. Geological Survey 2017)
Earthquake	Sa(0.2 sec, 5%), g or Sa(1.0 sec, 5%), g, both geographic mean of two orthogonal directions.	Petersen et al. (2014); Vs30 from OpenSHA.org site data app at tract geographic centroid (preferred value), F <sub>v</sub> from 2015 NEHRP Recommended Provisions (Federal Emergency Management Agency 2015d).
Fire	Burn probability Flame intensity level	Finney (2011); Short (2016) Byram (1959); Scott (2013)

(a) 2016 represents the best available hazard information.

### 4.12.1. Estimating Riverine Flood Hazard

A flood risk model has three key components: the delineation of the flood hazard; the exposure (buildings, population, etc.); and the methodology that relates the hazard to the exposure to derive economic and social impacts. These components can be compared to the legs of a chair. If one of the legs is weak, the chair collapses, or, in the case of a model, the model produces output that may lack credibility.

As discussed in Chapter 3, the lack of detailed flood hazard and exposure data was a limitation of the flood analysis in the 2005 study. In addition, at the time that study was completed, there were limited options for using GIS tools to analyze flood impacts. The lack of data limited the potential value of technologies such as Hazus. The present Interim Study applied improved modeling capabilities, and integrated data resources that were unavailable for the 2005 study.

The project team determined the majority of loss calculations in Hazus by applying depth-damage functions to evaluate the relationship between exposed buildings and other community assets, and a flood depth grid that defines the extent and severity of the hazard. Users can either create a depth grid with Hazus or they can provide their own depth grid. Since the 2005 study was completed, depth grids have been developed for a number of communities across the United States. FEMA's Risk MAP program has been especially helpful in this as it has led to the development of new information, including depth grids in some cases, to help communities understand and mitigate the impact of flood hazards.

The project team evaluated the availability of depth grids from Risk MAP and other sources for the Interim Study but determined that none were available within areas for which other critical study input such as building inventory was available. Accordingly, the project team used Hazus Release 3.2 to generate the depth grids needed for above-code measures as well as federal mitigation grants. While Hazus may deliver less-precise depth grids than those produced with more robust engineering tools and methods, they seem adequate for the Interim Study.

To support the analysis of designing to exceed I-Code requirements, the project team used both 1% annual chance return period (1% annual chance) and 500-year return period (0.2% annual chance) depth grids for each of the four counties included in the Interim Study (see Section 4.11.2) using the Hazus suite-of-return-periods option. These were based on a 1 arc-second digital elevation model and a 5-square-mile drainage threshold. To study the cost effectiveness of federal grants, the project team sometimes used a drainage threshold of less than 5 square miles, but always large enough to estimate flood hazard at the location of the mitigated building.<sup>17</sup>

### 4.12.2. Estimating Storm Surge Hazard

Nobody offers hazard data on regional probabilistic coastal surge. The project team therefore estimated probabilistic storm surge. In summary (details follow), the project team used worst-case evacuation maps that show evacuation zones for each of several Saffir-Simpson categories. The project team scaled the estimated surge heights to match local flood studies, and estimated the MRI from wind speed maps. The steps listed here provide a brief explanation of each dataset, followed by a description of the steps to estimate probabilistic storm surge elevation:

**Step 1:** Flood maps for NFIP (Federal Emergency Management Agency 2014d). FEMA digital flood maps provide the extent of analysis where a significant risk from storm surge justifies building above

---

<sup>17</sup> For details on how Hazus generates depth grids, see Federal Emergency Management Agency (2011b).

the required code. These data also provide a key indicator of the BFE: 6 feet above ground elevation at the landward edge of the delineated zone according to FEMA P-55 (Federal Emergency Management Agency 2011a). This provides a method to estimate the BFE regionally. The project team downloaded data for all states in the conterminous United States exposed to coastal storm surge. Although most areas had digital FEMA flood maps available, South Carolina did not have data available.

**Step 2:** Preliminary design wind speed maps from ASCE 7-16 (American Society of Civil Engineers Structural Engineering Institute 2017). Design wind speeds were used to model the probable return interval of hurricanes corresponding to the SSHWS. The project team acquired the data just before general release. The data are generally consistent with ASCE 7-10, but include the 3,000-year MRI to characterize rare storms.

**Step 3:** MOMs surge heights by SSHWS from NOAA (National Hurricane Center 2014). Emergency managers use the surge height estimates primarily for evacuation purposes. The surge heights also provide a consistent nationwide data source for assessing coastal surge hazards from hurricanes. NOAA delivers the data in separate GIS layers, each representing the maximum probable surge heights for a given SSHWS category. Using the ASCE 7-16 wind speeds (American Society of Civil Engineers Structural Engineering Institute 2017), one can assign each storm category a MRI given the wind hazard at the coast. (This process is discussed below.) The project team adjusted the maximum surge height regionally to represent a mean surge elevation using the FIS performed for the NFIP (FEMA, 2003, 2006a, b, 2007b, c, 2008c, d, 2009a, b, 2012a, b, c, 2013a, 2014b, c). The project team used approximately a dozen FIS studies to scale the MOMs and applied scaling factors for each of three regions: (1) Gulf states including western Florida; (2) eastern Florida up the coast to South Carolina, and (3) from North Carolina northward.

**Step 4:** USGS National Elevation Dataset (U.S. Geological Survey 2017). Ground elevation at a given site combined with the location nearest to a border between a V- or VE-zone in the FEMA flood maps (FEMA 2014d) provide the ground required to estimate the BFE at each location.

**Step 5:** NOAA global and regional SLR scenarios for the United States (Sweet et al. 2017). NOAA estimates SLR for gauge locations globally. The project team chose four scenarios: low, intermediate-low, intermediate-high, and extreme to represent a low, moderate, high, and extreme SLR scenario, and assigned the regional SLR by creating Thiessen polygons surrounding each location and assigning the closest gauge. The result is a map of likely regional SLR though time for off-shore point locations. Intermediate-low was chosen as the mean scenario, corresponding to global rise of 50 cm,  $\pm$  2 cm (approx. 20 in.  $\pm$  0.8 in.).

**Step 6:** NOAA SLR (National Oceanic and Atmospheric Administration 2017). In tandem with the Sweet et al. (2017) data, the NOAA SLR spatial datasets provide projected SLR on shore and on land for six scenarios representing 1 to 6 feet of inundation. The estimates do not model complex coastal impacts or erosion.



## NATURAL HAZARD MITIGATION SAVES:

Recall from Section 4.11.2 that the analysis uses 7,000 sample locations from the OpenStreetMap (2017) footprint data set. The project team estimated probabilistic hazard at the centroid of each sampled footprint, as follows:

**Step 1.** Estimate BFE. Estimating the BFE required two elevation levels: the elevation at the centroid of the OSM footprint ( $E_1$ ) and the elevation at the inland location representing the transition from the V- or VE-zone ( $E_2$ ) (FEMA 2011a). The project team did not analyze the cost effectiveness of building above coastal A-zones because these zones are not identified in the NFIP data. The project team determined the location at which to estimate  $E_2$  using a custom Python application that accesses a PostgreSQL database (an open-source relational database system) developed for this purpose. One can then calculate BFE as shown in Equation 4-20. See Step 5 below for the meaning of the factor of 1.55.

$$BFE = (E_2 + 3.85 - E_1) \times 1.55$$

Equation 4-20

**Step 2:** Estimate mean recurrences interval using Saffir-Simpson category. NOAA provides MOMs surge estimates (National Hurricane Center 2014) for Category-1 to Category-5 storms, but what is their MRI? The ASCE 7-16 wind speed data (American Society of Civil Engineers Structural Engineering Institute 2017) provides wind speeds with each of seven MRIs. The project team used the latter to estimate the former, as follows. Let  $i$  denote an index to seven pairs  $(x_i, y_i)$  of data, where  $x_i$  denotes 3-second peak gust velocity at 10-meter elevations and  $y_i$  denotes MRI in years. The project team extracted seven such pairs from the ASCE 7-16 wind speed maps for each location of interest. The pairs have common  $y$  values:  $y_1 = 10$  years,  $y_2 = 25$  years, etc., at each location. The other  $y$  values are 100, 300, 700, 1,700, and 3,000 years. Let  $x$  denote the wind speed at the midpoint between lower and upper bounds of the peak gust velocity for each Saffir-Simpson category. The project team estimated  $y$ , the MRI for each Saffir-Simpson intensity at each location by linear interpolation within  $(x_i, y_i)$  data, e.g., Equation 4-21, where  $x_0$  refers to the maximum  $x_i$  such that  $x_i \leq x$ ,  $x_1$  refers to the minimum  $x_i$  such that  $x < x_i$  and  $y_0$  and  $y_1$  are the  $y$ -coordinates of  $x_0$  and  $x_1$ , respectively.

$$y = y_0 + (x - x_0) \frac{y_1 - y_0}{x_1 - x_0}$$

Equation 4-21

**Step 3.** Estimate surge height. For each location, use GIS to extract the surge elevation by Saffir-Simpson category from the NOAA MOMs (National Hurricane Center 2014). Given that NOAA MOMs provide a worst-case scenario for evacuation purposes, these estimates need to be adjusted to represent mean surge elevation. Several FIS studies (Federal Emergency Management Agency 2003, 2006a and b, 2007b and c, 2008c and d, 2009a and b, 2012a, 2013a, 2014b and c) provide surveyed data suitable for adjusting the expected surge elevation given a return interval. For each study, the project team entered surge estimates for approximately 5 locations into a GIS database and extracted

the estimated storm surge by Saffir-Simpson category. For each Saffir-Simpson category, analysts used linear interpolation to assign a return interval using the same method described in Step 2 above. The result was two datasets: MOMs surge height versus MRI and FIS surge height versus MRI. The project team took the FIS as a mean estimate of surge and MOMs as an upper bound. The ratio of the latter to the former at a given MRI estimates the degree to which MOMs surge heights are greater than best estimates. The project team used the ratio to de-amplify MOMs surge heights to best estimates. Figure 4-15 provides an example for Pinellas County, Florida (FEMA 2009b).

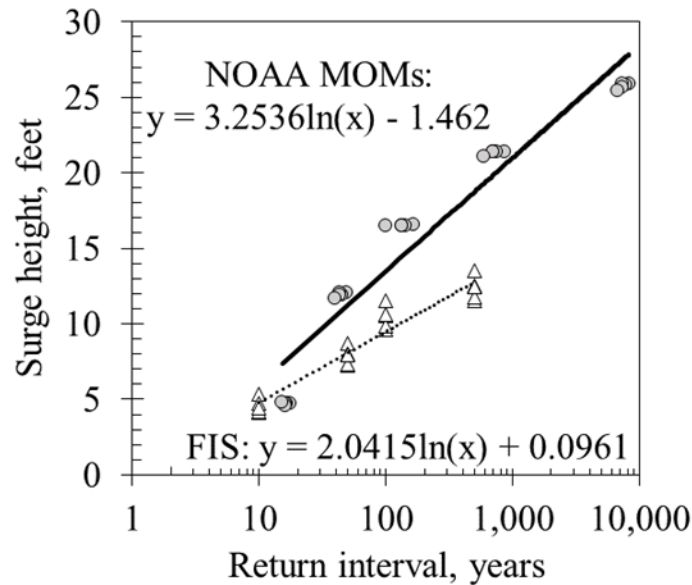

**Figure 4-15:** Sample data for adjusting NOAA MOMs surge elevations (National Hurricane Center 2014) to FEMA FIS estimates, Pinellas County, Florida (Federal Emergency Management Agency 2009b).

**Step 4.** Accounting for SLR. SLR is a cumulative hazard that impacts coastal surge elevation as well as the effectiveness of mitigation. For each location and for each SLR scenario, the NOAA global and regional SLR scenarios (National Oceanic and Atmospheric Administration 2017) provide an estimated height in feet (data set 5, above). Given that elevation in feet, the project team added the corresponding NOAA projected SLR (data set 6) to the NOAA MOMs (National Hurricane Center 2014). To account for SLR, the project team divided the 75-year projected lifespan of a building into five 15-year intervals and assessed benefits at the midpoint (2025, 2040, 2055, 2070, 2085). Future benefits for distant time slices were discounted accordingly.

**Step 5.** Accounting for wave height. MOMs (National Hurricane Center 2014) estimate stillwater surge elevation. After adjusting these values and added SLR, the project team multiplied the values by 1.55 to account for wave height. Hence the factor of 1.55 in Equation 4-19.

**Step 6.** Removal of benefits for locations under water due to SLR alone. In cases that the SLR reaches the building footprint, no benefits are realized from that year on. That is, if a house is still dry between high and low tide given a SLR estimate, there may be benefits to mitigation. However, if the house is

not dry between high and low tide, benefits are no longer realized. The BCR excludes any benefits to buildings that cannot be reached because the surrounding land is regularly flooded.

**Step 7.** Estimation of surge depth. The project team assessed damage using the value of projected surge depth above lowest floor elevation. For records not removed under Step 6 above, this is the difference between the value from Step 5 and the value in Step 1, modified to account for additional elevation above the BFE.

### 4.12.3. Estimating Hurricane Wind Hazard

The project team used the wind speed maps from ASCE 7-16 (American Society of Civil Engineers Structural Engineering Institute 2017). These maps, which were delivered to the project team before general release, show wind speeds for different return intervals. For the Interim, the area of analysis covers all locations where a wind speed with 7% exceedance probability in 50 years exceeds 115 mph, and in some cases 110 mph where BCR exceeds 1.0. The analysis does not consider mitigation benefits for those structures subject to tornado wind. This choice refers to the basic wind speed used for design of ordinary buildings, ASCE 7-10 Risk Category II. The wind speed with a 7% exceedance probability in 50 years corresponds to a 700-year MRI.

Assessing BCR for this wide area required geographic simplification. There are thousands of combinations of wind speeds by return interval throughout the entire area. Two places where 700-year wind speed of 120 mph can have different values of wind speed with a different MRI. It turns out however that, considering places with the same 700-year wind speed, the variability of the wind speeds associated with the other MRIs was quite small: their standard deviation was less than 5 mph. The project team therefore estimated exposure by 700-year wind speed, and estimated a population-weighted average of the wind speed with other MRIs, as described next. Simplifying the hazard in this way allows for a more sophisticated assessment of options to designing to exceed I-Code requirements associated with the IBHS FORTIFIED Home Hurricane and High Wind program (Insurance Institute for Business & Home Safety 2012, 2015).

When designing most ordinary buildings to meet the 2015 IBC, engineers start with a so-called basic wind speed that has approximately a 7% probability of exceedance in 50 years, which corresponds to an annual exceedance probability of 0.00143 and a MRI of 700 years. In this section, the project team was not so much concerned with design as with wind hazard—engineers' best estimate of the frequency with which various wind speeds are exceeded. Here is how to calculate a population-weighted-average wind speed for MRIs other than 700 years, namely 10, 50, 100, 300, and 1,700 years.

The project team created a spatial overlay that included the remaining MRI wind contours and the Atlantic and Gulf Coast state boundaries. This resulted in a set of polygons that represented wind speeds for all MRIs for each location. For example, see how various contours for South Florida cross in Figure 4-16, creating polygons with various combinations of wind speeds with 10, 50, 100, 300, 700, and 1,700-year MRIs. Rather than deal with the thousands of polygons, the project team estimated the population by 700-

## NATURAL HAZARD MITIGATION SAVES:

year wind speed band and, for each band, calculated the weighted average wind speed for the remaining MRIs (10, 50, 100, 300, and 1,700 years) using the population of each polygon.

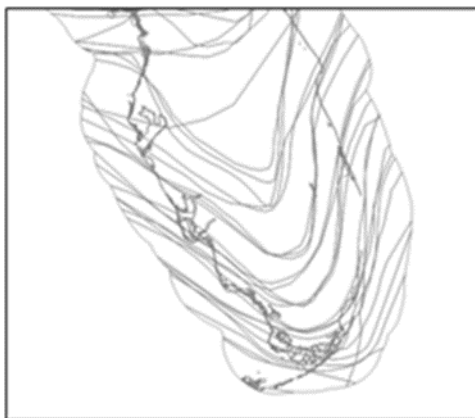

**Figure 4-16:** South Florida wind speed combination example.

As a simplified example, suppose the population where 700-year wind speed is approximately 115 mph is 1,000 people. Suppose two contours for the 1,700-year MRI intersect the region, one with a population of 750 and a 1,700-year wind speed of 120 mph, and the other with a population of 250 with a 1,700-year wind speed of 130 mph. Thus, 75% of the population have a 1,700-year wind speed of 120 mph and the other 25% have a 1,700-year wind speed of 130 mph, and all 1,000 have a 700-year wind speed of 115 mph. The project team replaced the two subgroups with a single population of 1,000 where 1,700-year wind speed is  $0.75 \cdot 120 \text{ mph} + 0.25 \cdot 130 \text{ mph} = 122.5 \text{ mph}$ . That is, treat the hazard where those 1,000 people live as uniform: all 1,000 people are exposed to a 700-year wind speed of 115 mph and a 1,700-year wind speed of 122.5 mph. Table 4-17 shows the resulting weighted average wind speeds by MRI. For example, suppose a location has a 700-year wind speed of 110 mph according to the ASCE 7-16 map of basic wind speed for occupancy category II buildings. Reading the first row of Table 4-17, that location would be estimated to have a 10-year wind speed, e.g., the wind speed associated with a MRI of 10 years, of 71 mph, as shown in the first column of the first row.

ASCE 7-16 identifies wind-borne debris regions along the Gulf and Atlantic Coast where 700-year wind speeds are greater than 130 mph. The project team created a 1-mile buffer for these areas and intersected with the hazard map through a GIS process. The resulting map allowed the project team to extract the values (mph) for any given return interval, at any location, and identify whether the property is within 1 mile of the coast. Although the 1-mile buffer is not visible at this scale, Figure 4-17 depicts the final hazard map with county boundaries.

**Table 4-17:** Population-weighted wind speeds (mph) by return interval, given 700-year wind speed contours.

	Mean recurrence interval (years)					
	10	50	100	300	700 <sup>(a)</sup>	1,700
Population-weighted wind speed (mph)	71	85	95	105	110	120
	71	87	95	105	115	120
	73	91	98	110	120	129
	75	98	107	120	130	139
	77	101	112	129	140	149
	75	100	119	130	145	150
	80	110	121	138	150	161
	80	119	130	149	160	172
	80	120	137	151	170	181
	81	130	147	166	180	196

(a) 700-year wind speed is a baseline, meaning that one applies wind hazard curves—essentially rows in this table—to a location based on its 700-year wind speed. The other columns in the row give the population-weighted average wind speed with the specified mean recurrence interval, even though the wind speed with 10-, 50-, 100-, 300-, or 1,700-year mean recurrence interval may differ at an actual location with the specified 700-year wind speed.

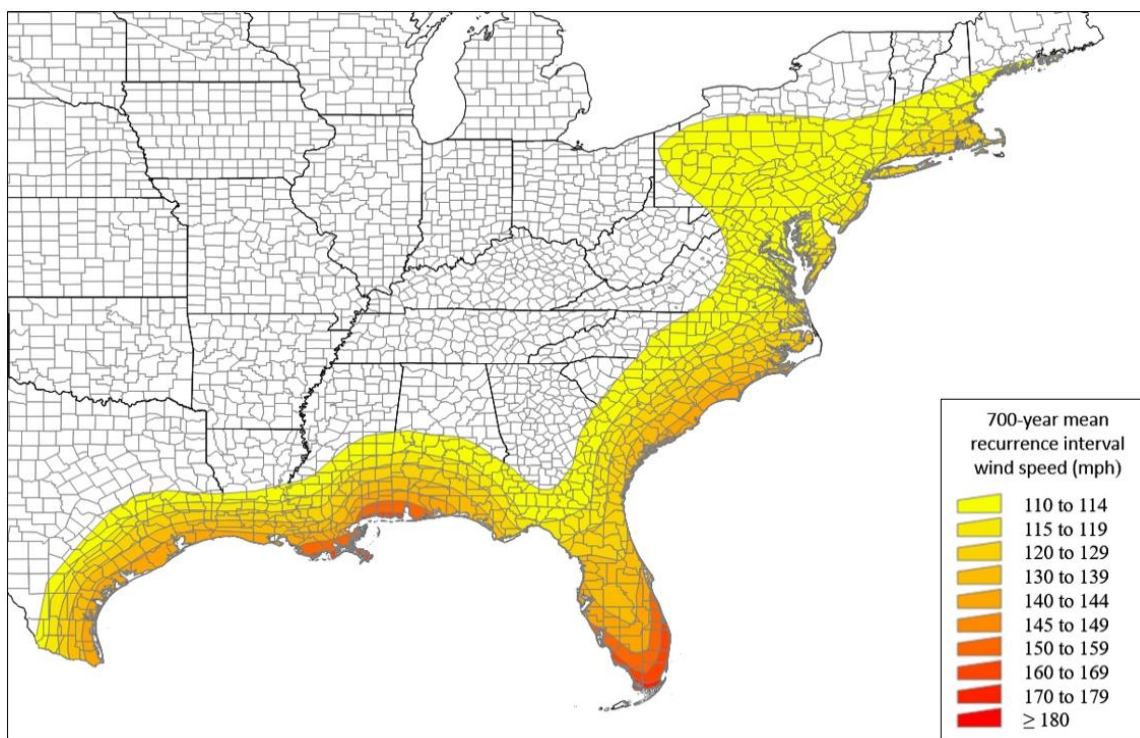

Figure 4-17: ASCE 7-16 700-year wind speeds.

#### 4.12.4. Estimating Tornado Wind Hazard

Because of rapid population growth and observation bias in existing tornado databases, it is difficult to characterize tornado wind hazard effectively. However, given that tornado shelters mitigate injuries and loss of life only, tornado hazard can be assessed indirectly, based on the number of fatalities (i.e., risk rather than hazard), for which there are good statistics. NOAA’s NWS (National Weather Service 2017) provides a database of fatalities by state and by year from 1950 to 2016. The project team divided these values by the USCB’s state population estimates (U.S. Census Bureau 2017) to estimate fatalities per capita per year by state. This analysis assumes safe rooms and shelters are perfectly effective in preventing death and injury when people use them. The analysis excludes data prior to 1950 to recognize the widespread use of tornado sirens and how sirens greatly reduce fatalities.

#### 4.12.5. Estimating Seismic Hazard

This work considers ground shaking as the main peril that causes damage in earthquakes, and ignores other perils, such as liquefaction, landsliding, and fault offset. These other perils can be important in certain circumstances. For example, in the 2011 Christchurch (New Zealand) Earthquake, liquefaction damage contributed a much larger fraction to aggregate loss than is usual in California earthquakes. Closer to home, the 1906 San Francisco Earthquake might have had a much milder outcome if liquefaction had not heavily damaged the water supply system. Water supply damage prevented effective fire department response. Fire led to the bulk of the losses and deaths. However, setting aside urban conflagration, shaking

## NATURAL HAZARD MITIGATION SAVES:

tends to dominate U.S. building damage, so focusing on shaking seems reasonable for assessing the costs and benefits of seismic designs to exceed I-Code requirements, and also for assessing federal grants.

The USGS distributes the 2014 National Seismic Hazard Maps (Petersen 2014) in various formats. The most relevant one contains gridded seismic hazard curves for the 48 conterminous states, showing probability in 1 year of shaking exceeding each of 20 levels of spectral acceleration response from less than 0.01 g to more than 5.0 g in logarithmic increments. The hazard curves are calculated for site conditions with average shearwave velocity in the upper 30 meters of soil ( $V_{s30}$ ) equal to 760 m/s, corresponding to the boundary between NEHRP site classes B and C.

When the project team commenced the *Report*, the 2014 gridded hazard curves were not yet available for Alaska, Hawaii, and other portions of the United States outside the conterminous United States. The USGS had not yet published the gridded hazard data for any of the 2016 National Seismic Hazard Maps<sup>18</sup>, or for the portion of the United States outside the conterminous United States for the 2008 National Seismic Hazard Maps. The project team decided at the beginning of this project not to search for data that were not readily available, even if those data ought to exist. The project team therefore did not contact the USGS in search of either of these unpublished data sets. The project team acquired  $V_{s30}$  for all U.S. Census tracts using the USGS's OpenSHA site data app, the latest release version as of November 29, 2016, and used the preferred data: generally, Wills and Clahan (2006) for California and Allen and Wald (2007) for other states.

Both groups (Wills at California Geological Survey and Wald at USGS) produced later revisions to their maps of  $V_{s30}$ , but neither had been incorporated into OpenSHA as of the start of this work. The project team opted to use the slightly older maps for convenience and because any errors in the accuracy of  $V_{s30}$  for individual sites would tend to be cancelled out among the larger sample.

Current standard practice requires addressing site amplification using NEHRP site classes rather than  $V_{s30}$ . The project team mapped from  $V_{s30}$  to NEHRP site class using the same ranges of  $V_{s30}$  that the 2015 NEHRP Recommended Seismic Provisions (Federal Emergency Management Agency 2015d) do. The project team did so in two different ways: one using the standard set of NEHRP site classes (A, B, C, D, and E), as in Table 4-18 and another with boundary soil types (e.g., BC, CD, DE), according to Table 4-19. The former was used to calculate design parameters  $S_{MS}$  and  $S_{M1}$ , while the latter were used to calculate the hazard to which buildings are subjected, with slightly more refinement than the standard NEHRP site amplification allows.

**Table 4-18:** NEHRP site classes and associated  $V_{s30}$ , used for estimating design requirements.

Site class	$V_{s30}$ (m/sec)
A	$\geq 1500$
B	760-1599

<sup>18</sup> To learn more visit: <https://earthquake.usgs.gov/hazards/hazmaps/conterminous/index.php#2016>.

C	360-760
D	180-360
E	< 180

Table 4-19: NEHRP site classes and boundary classes with Vs30, used for estimating hazard.

Site class	Vs30 (m/sec)
A	≥ 1780
AB	1260 - 1779
B	900 - 1259
BC	630 - 899
C	430 - 629
CD	300 - 429
D	210 - 299
DE	150 - 209
E	< 150

To estimate hazard at census-tract centroids, find the nearest four grid points in the gridded national seismic hazard maps, extract their hazard curves from the gridded seismic hazard data, spatially interpolate exceedance frequency at each of many levels of ground motion, and then adjust the interpolated hazard curve to account for its site conditions. The project team made the adjustment by factoring the ground motion on BC soil by the appropriate value of the site coefficient  $F_a$  or  $F_v$  from Table 11.4-2 of the 2015 NEHRP Recommended Seismic Provisions (Federal Emergency Management Agency 2015d). The project team added  $F_a$  and  $F_v$  values for the boundary site classes AB, BC, etc., averaging the relevant values, as shown in Table 4-20 and Table 4-21. (Site coefficients increase or decrease spectral acceleration response to account for amplification of ground motion on sites with other values of Vs30 than 760 m/sec.) The result is the ground motion hazard curve to characterize site hazard.

Table 4-20: Site coefficient  $F_a$  as a function of  $S_a(0.2 \text{ sec}, 5\%)$  on site class BC, denoted  $h_s$ .

Site class	$h_s = S_a(0.2 \text{ sec}, 5\%), g^{(a)}$					
	$h_s \leq 0.25$	0.50	0.75	1.00	1.25	$h_s \geq 1.50$
A	0.80	0.80	0.80	0.80	0.80	0.80
AB	0.85	0.85	0.85	0.85	0.85	0.85
B	0.90	0.90	0.90	0.90	0.90	0.90
BC	1.00	1.00	1.00	1.00	1.00	1.00
C	1.30	1.30	1.20	1.20	1.20	1.20
CD	1.45	1.35	1.20	1.15	1.10	1.10



## NATURAL HAZARD MITIGATION SAVES:

D	1.60	1.40	1.20	1.10	1.00	1.00
DE	2.00	1.55	1.25	1.13	1.00	1.00
E	2.40	1.70	1.30	1.15	1.00	1.00

(a) Federal Emergency Management Agency (2015) instructs the user to linearly interpolate between values of  $h_s$

**Table 4-21:** Site coefficient  $F_v$  as a function of  $S_a(1.0 \text{ sec}, 5\%)$  on site class BC, denoted  $h_1$ .

Site class	$h_1 = S_a(1.0 \text{ sec}, 5\%), g^{(a)}$					
	$h_1 \leq 0.10$	0.20	0.30	0.40	0.50	$h_1 \geq 0.60$
A	0.80	0.80	0.80	0.80	0.80	0.80
AB	0.80	0.80	0.80	0.80	0.80	0.80
B	0.80	0.80	0.80	0.80	0.80	0.80
BC	1.00	1.00	1.00	1.00	1.00	1.00
C	1.50	1.50	1.50	1.50	1.50	1.40
CD	1.95	1.86	1.76	1.71	1.66	1.56
D	2.40	2.21	2.01	1.91	1.81	1.71
DE	3.30	2.76	2.41	2.16	2.01	1.86
E	4.20	3.31	2.81	2.41	2.21	2.01

(a) Federal Emergency Management Agency (2015) instructs the user to linearly interpolate between values of  $h_1$

One can perform the spatial interpolation and site amplification of seismic hazard as follows. Let the longitude  $\lambda$  and latitude  $\alpha$  of an arbitrary location within the boundaries of the NSHMP be denoted by the coordinate pair  $(\lambda, \alpha)$ . Let the NEHRP site class at that location be denoted by  $\sigma$ . Let the hazard curve for an arbitrary location be denoted by an  $N \times 2$  array where  $N$  rows correspond to the  $N$  intensity measure levels of the NSHMP hazard curves. NSHMP presents seismic hazard in terms of  $N = 20$  pairs  $(h_i, p_i)$ , where  $h_i$  denotes the  $i^{\text{th}}$  intensity measure level and  $p_i$  denotes the probability that the site will experience shaking of intensity measure level at least  $h_i$  at least once in a given year. One can use Equation 4-22 to convert from 1-year exceedance probability  $p_i$  to mean annual exceedance frequency  $G_i$  (in units of events per year). Equation 4-22 assumes Poisson arrivals of earthquakes during a 1-year period. The NSHMP provides hazard at 0.05-degree grid points on BC soil. Considering an arbitrary location within the boundaries of the NSHMP map, one finds the four closest grid points. The western and eastern longitudes of the four closest grid points will be denoted by  $\lambda_0$  and  $\lambda_1$  respectively, and the southern and northern latitudes of the four nearest grid point by  $\alpha_0$  and  $\alpha_1$  respectively. In order to map to a normalized coordinate system, the coordinates of the southwest, northwest, southeast, and northeast grid points will be denoted by the coordinates (0,0), (0,1), (1,0), and (1,1), respectively. Map the geographic coordinates of the location of

## NATURAL HAZARD MITIGATION SAVES:

interest  $(\lambda, \alpha)$  to a normalized coordinate pair  $(x^*, y^*)$  by Equation 4-23, and then interpolate hazard on BC soil at  $(x^*, y^*)$  using Equation 4-24.

$$G_i = -\ln(1 - p_i)$$

Equation 4-22

$$x^* = \frac{\lambda - \lambda_0}{\lambda_1 - \lambda_0}, y^* = \frac{\alpha - \alpha_0}{\alpha_1 - \alpha_0}$$

Equation 4-23

$$G_i(x^*, y^*) = a \cdot x^* + b \cdot y^* + c \cdot x^* \cdot y^* + d$$

Equation 4-24

Where,

$$a = G_i(1,0) - G_i(0,0)$$

$$b = G_i(0,1) - G_i(0,0)$$

$$c = G_i(1,1) + G_i(0,0) - G_i(1,0) - G_i(0,1)$$

$$d = G_i(0,0)$$

To account for site amplification or deamplification, use *NEHRP Recommended Provisions* site coefficient  $F_a$  or  $F_v$ , as appropriate, using Equation 4-25 or Equation 4-26, as is standard accepted practice (Federal Emergency Management Agency 2015d). Equation 4-25 deals with short-period spectral acceleration response. In the equation,  $h_{i,S}$ ,  $F_a(h_{i,S}, \sigma)$ , and  $h_{i,MS}$  respectively denote 5% damped elastic spectral acceleration response at 0.2-second period at level  $i$  on BC soil; the short-period amplification factor evaluated at  $h_{i,S}$  for site class  $\sigma$ , and the 5% damped spectral acceleration response at 0.2-second period at level  $i$  on site class  $\sigma$ . Equation 4-26 deals with spectral acceleration response at a 1-second period. In the equation,  $h_{i,1}$ ,  $F_v(h_{i,1}, \sigma)$ , and  $h_{i,M1}$  respectively denote 5% damped elastic spectral acceleration response at 1.0-second period at level  $i$  on BC soil; the 1-second amplification factor evaluated at  $h_{i,1}$  for site class  $\sigma$ , and the 5% damped spectral acceleration response at 1.0-second period at level  $i$  on site class  $\sigma$ . When estimating hazard at intensity measure levels between any two levels  $i$  and  $i+1$  of the NSHMP, treat the natural logarithm of the exceedance frequency as varying linearly with the intensity measure level, as is common.

$$h_{i,MS} = F_a(h_{i,S}, \sigma) \cdot h_{i,S}$$

Equation 4-25

$$h_{i,M1} = F_v(h_{i,1}, \sigma) \cdot h_{i,1}$$

Equation 4-26

## NATURAL HAZARD MITIGATION SAVES:

For example, consider seismic hazard in census tract 06001403100, the one shown in Figure 4-13 with a blue dot, e.g., California (06), Alameda County (001), Tract 403100. The tract's geographic centroid is located at 37.8023N, -122.2755E. OpenSHA's site data application version 1.3.2 shows that on the Wills and Clahan (2006) geologic map of California, the Vs30 at that location is 302 m/sec (Figure 4-18). As shown in Table 4-19, 302 m/sec corresponds to site class CD.

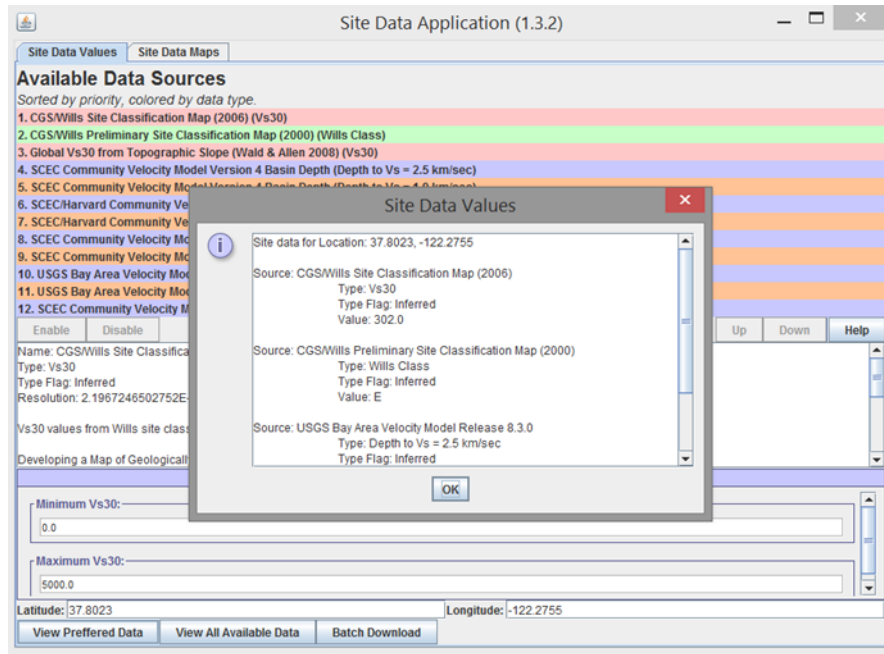

Figure 4-18: Sample calculation of Vs30 using OpenSHA site data application.

According to the NSHMP, the hazard in terms of 1-sec 5%-damped spectral acceleration response at four nearby locations (37.80N, -122.30E), (37.85N, -122.30E), (37.80N, -122.25E), and (38.85N, -122.25E) on a hypothetical site ( $x, y$ ) with Vs30 = 760 m/sec as is shown in Figure 4-19A. (This example deals with the constant-velocity portion of the response spectrum, but it is only an example. Similar procedures apply to the constant-acceleration portion of the response spectrum.) The coordinates of the site in question (37.8023N, -122.2755E) can be mapped to the normalized coordinates ( $x^*, y^*$ ) by Equation 4-23 as follows:

$$x^* = \frac{\lambda - \lambda_0}{\lambda_1 - \lambda_0} = \frac{-122.2755 + 122.30}{-122.25 + 122.30} = 0.49$$

$$y^* = \frac{\alpha - \alpha_0}{\alpha_1 - \alpha_0} = \frac{37.8023 - 37.80}{37.85 - 37.80} = 0.045$$

NSHMP estimates the 1-year exceedance probability  $p$  of  $S_a(1.0 \text{ sec}, 5\%) = 0.0025g$  on site class BC as shown in the column labeled  $p$  in Table 4-22. Calculate exceedance frequency for each grid point using Equation 4-22, e.g., for the first row,

$$G_i = -\ln(1 - p_i) = -\ln(1 - 0.54841) = 0.7950$$

Table 4-22: Sample calculation of G for  $S_a(1.0 \text{ sec}, 5\%, \text{BC}) = 0.0025g$ .

Lat N	Lon E	Coords	P	G, yr <sup>-1</sup>
37.80	-122.30	(0,0)	0.54841	0.7950
37.85	-122.30	(0,1)	0.54614	0.7900
37.80	-122.25	(1,0)	0.55668	0.8135
37.85	-122.25	(1,1)	0.55337	0.8060

Then calculate the exceedance frequency of  $S_a(1.0 \text{ sec}, 5\%, \text{BC}) = 0.0025g$  at  $(x^*, y^*)$  using Equation 4-27:

$$a = G_i(1,0) - G_i(0,0) = 0.8135 - 0.7950 = 0.0185$$

$$b = G_i(0,1) - G_i(0,0) = 0.7900 - 0.7950 = -0.0050$$

$$c = G_i(1,1) + G_i(0,0) - G_i(1,0) - G_i(0,1) = 0.8060 + 0.7950 - 0.8135 - 0.7900 = -0.0025$$

$$d = G_i(0,0) = 0.7950$$

Equation 4-27

$$\begin{aligned} G_i(x^*, y^*) &= a \times x^* + b \times y^* + c \times x^* \times y^* + d \\ &= 0.0185 \times 0.49 - 0.0050 \times 0.045 - 0.0025 \times 0.49 \times 0.045 + 0.7950 \\ &= 0.8037 \end{aligned}$$

Equation 4-28

Repeating for all other values of  $h_1$  produces the hazard curve shown in Figure 4-19A for a site at location  $(x^*, y^*)$  and site class BC.

Now consider site hazard accounting for site amplification. The site class of the site of interest is CD. Recall that here,  $h_1 = 0.0025g$  (the first value in each hazard curve of the NSHMP gridded seismic hazard data for 1-second spectral acceleration response). Referring to Table 4-21, the row labeled "CD" and the column labeled  $h_1 \leq 0.10g$ ,  $F_v = 1.95$ . Thus, by Equation 4-29,

$$h_{M1} = F_v(h_1, \sigma) \cdot h_1 = 1.95 \times 0.0025g = 0.0049g$$

Equation 4-29

One repeats for all other values of  $h_{M1}$ , producing the hazard curve shown in Figure 4-19B.

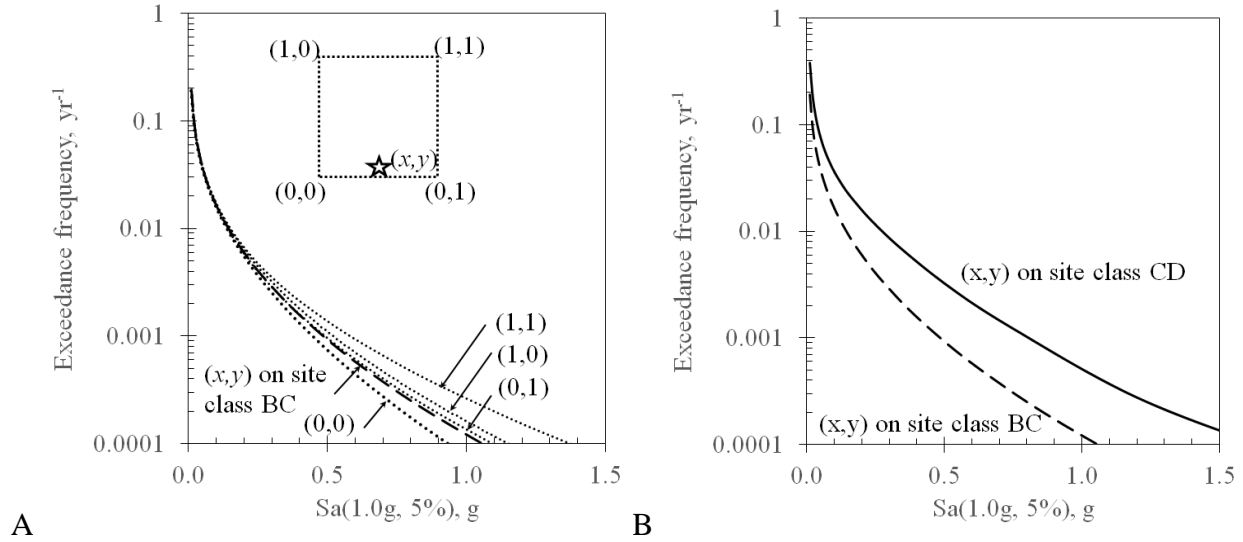

Figure 4-19: (A) Spatial interpolation of site hazard followed by (B) factoring for site effects.

The project team stratified hazard using FEMA P-154 (Federal Emergency Management Agency 2015e) seismicity regions, as defined in that document’s Table 2-2 (duplicated in Table 4-23), and mapped in its Figure A-1 (duplicated in Figure 4-20). The map assigns to a county the highest hazard anywhere in that county. However, the figure is *only* used to stratify the sample, not to quantify site-specific hazard for calculating BCR. The actual site-specific hazard is used in the calculation of each mitigation effort’s BCR.

## NATURAL HAZARD MITIGATION SAVES:

Table 4-23: Definition of FEMA P-154 (Federal Emergency Management Agency 2015e) seismicity regions.

Seismicity Region		Spectral Acceleration Response, $S_s$ (short-period, or 0.2 seconds)	Spectral Acceleration Response, $S_l$ (long-period, or 1.0 second)
	Low	less than 0.250g	less than 0.100g
	Moderate	greater than or equal to 0.250g but less than 0.500g	greater than or equal to 0.100g but less than 0.200g
	Moderately High	greater than or equal to 0.500g but less than 1.000g	greater than or equal to 0.200g but less than 0.400g
	High	greater than or equal to 1.000g but less than 1.500g	greater than or equal to 0.400g but less than 0.600g
	Very High	greater than or equal to 1.500g	greater than or equal to 0.600g

Notes: g = acceleration of gravity in horizontal direction

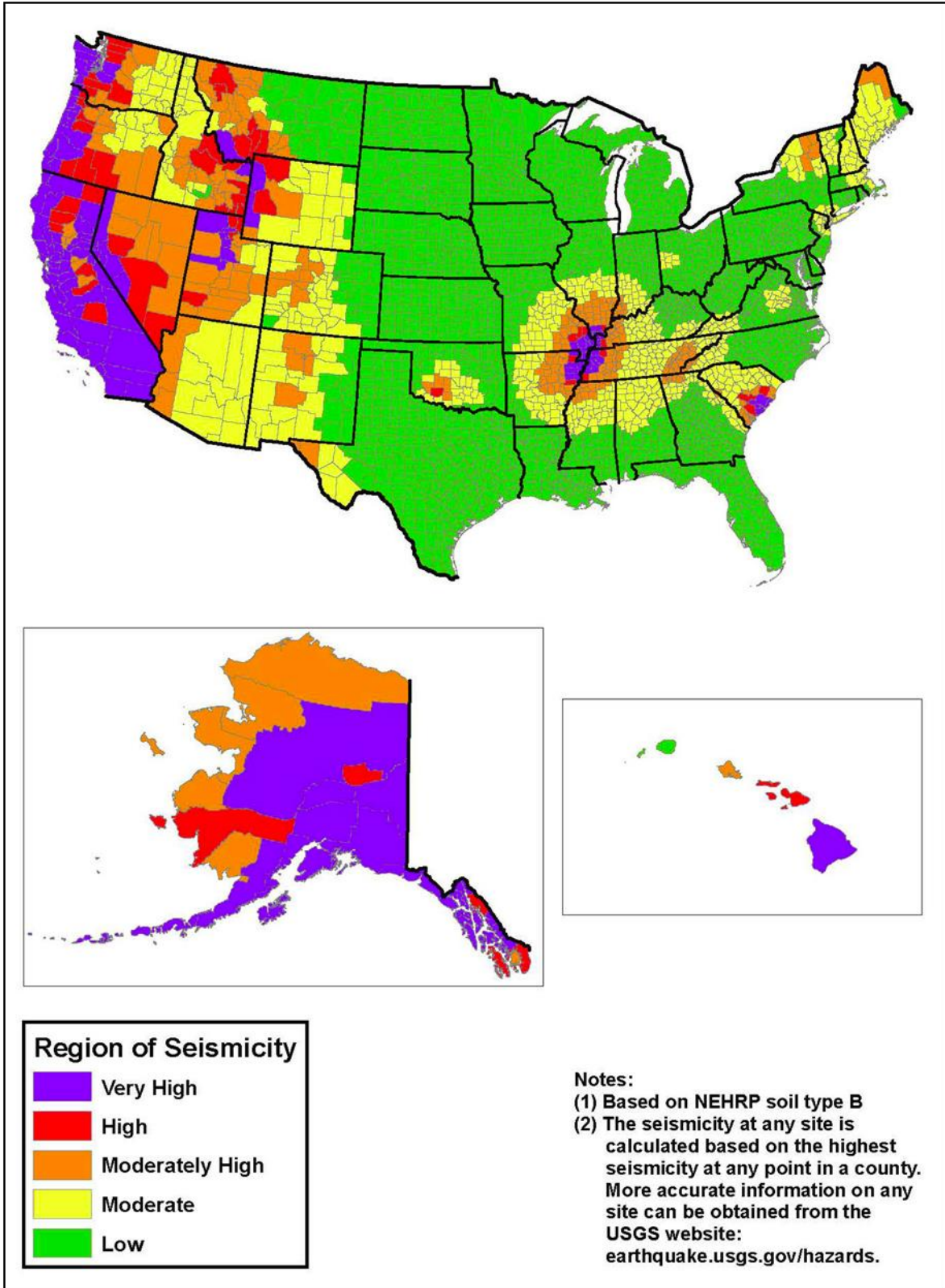

Figure 4-20: FEMA P-154 (Federal Emergency Management Agency 2015e) seismicity regions.

### 4.12.6. Estimating Fire Hazard

Similar to earthquake, flood, and other hazards, fires at the WUI (WUI fires) have been the subject of considerable analysis and mapping by federal agencies, particularly the U.S. Forest Service (USFS), which used simulation to develop a national map of BPs (Finney et al. 2011; Short et al. 2016). Burn probability (BP) here means the number of times a location experiences wildland fire (either by initiation or extension) per year. This WUI fire hazard mapping appears to be the most detailed and extensive of its kind, unique at the national level. The Interim Study employs it, as do many insurers. BP estimates the occurrence probability of a fire, but does not indicate the intensity of the fire, which is a function of fuel and other factors. Fire intensity level (FIL), also termed fireline intensity (FLI), measures the rate of heat release per unit length of flaming fire front (kW/m), regardless of flame front depth (Byram 1959; Scott 2013). Similar to BPs, an FIL dataset is available for the conterminous United States (Short et al. 2016). The product of BP and FIL provides a probability of FIL and ignition.

The project team assigned high, medium, and low WUI fire hazard strata based on USFS Wildfire Hazard Potential (WHP). Figure 4-21 presents maps of the conterminous United States for both BPs and WHPs. The project team mapped USFS WHP to hazard categories low, medium, and high hazard for sampling purposes as shown in Table 4-24. Under this stratification scheme, an approximately equal number of counties in the conterminous United States can be considered low, medium, and high hazard, as shown in Figure 4-22. The project team used the strata for purposes of stratified sampling of wildfire-related grants from HMGP, PA, etc.

**Table 4-24:** Mapping 2014 USFS WHP to the 2017 *Interim Report* fire hazard strata for purposes of sample stratification.

USFS WHP	Number of counties	Area of counties	MSv2 fire hazard
1	6%	1%	Low
2	9%	3%	Low
3	15%	9%	Low
4	33%	24%	Moderate
5	37%	63%	High



## NATURAL HAZARD MITIGATION SAVES:

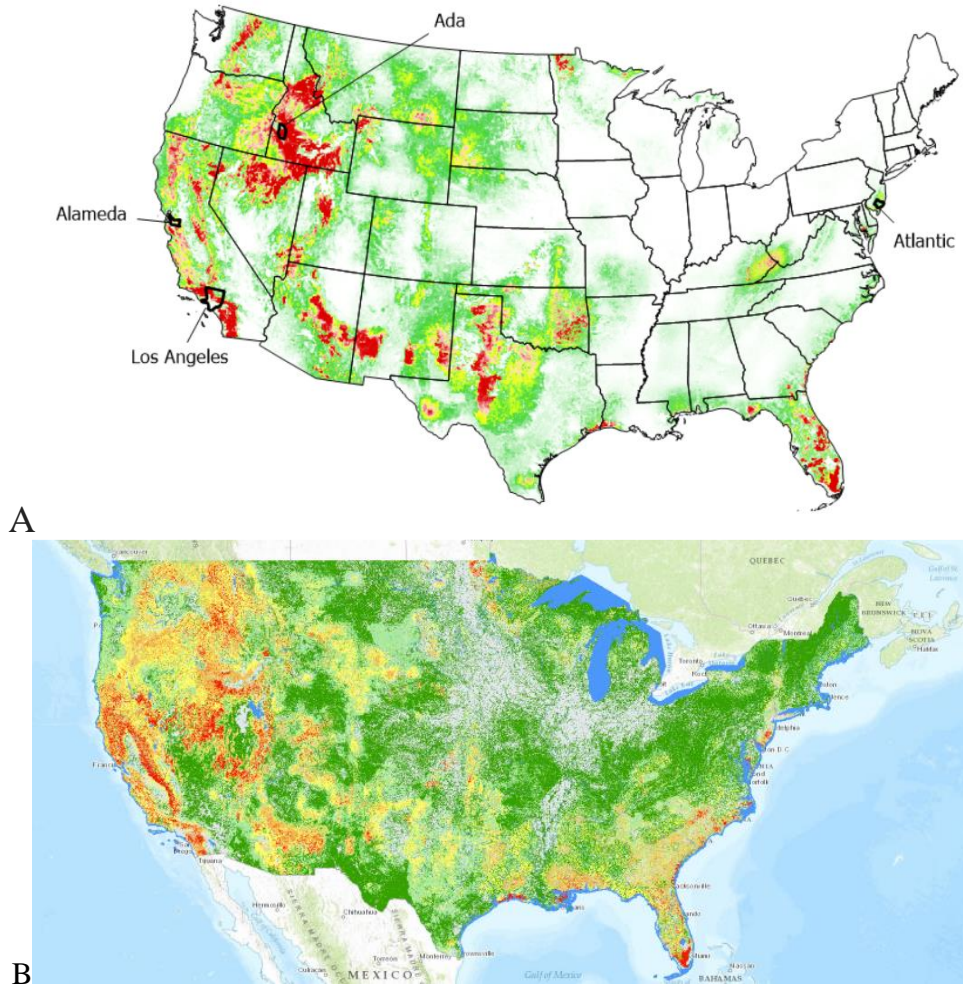

Figure 4-21: (A) USFS BPs with four study counties indicated. (B) USFS 2014 wildfire hazard potential, plus water and non-burnable areas.

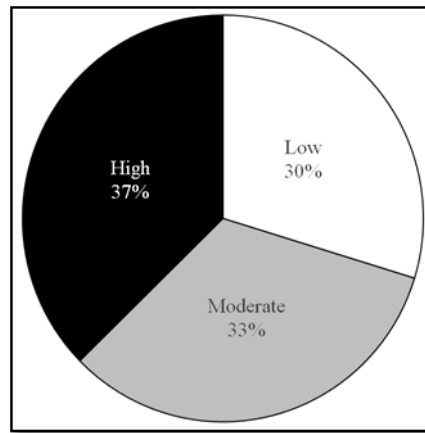

Figure 4-22: Number of U.S. counties in the conterminous United States by 2017 Interim Report fire hazard stratum.

Equation 4-30 provides the calculation of *EAL* using the terminology of fire-protection engineers:

$$EAL = \sum_{i=\text{all CBs}} V_{i,k} BP_i FP_i SE_{BP_i} \sum_{FIL=1,6} FIL_{i,j} RF_{j,k}$$

Equation 4-30

Where,

*EAL* = expected annualized loss

$V_{i,k}$  = value in grid cell *i* of exposure type *k* (only *k*=1 is used here)

$BP_i$  = one-year burn probability in grid cell *i*

$FP_i$  = fire penetration of WUI fire into the census block corresponding to grid cell *i*

$SE_{BP_i}$  = suppression effectiveness, a function of burn probability in grid cell *i*

$FIL_{i,j}$  = *j*th class of fireline intensity in grid cell *i*

$RF_{j,k}$  = response function for exposure type *k* given  $FIL_j$

$FP_i$ , the fire penetration of wildland-urban-interface fire into the census block corresponding to grid cell *i*, is taken as 700m based on Chen and McAneney (2004). Specifically, the project team approximated each census block as a square, and the fraction of the square's area equal to length of a side multiplied by 700m was taken as  $FP_i$ .

$SE_{BP_i}$ , the suppression effectiveness (a function of burn probability in grid cell *i*) accounts for active fire suppression. It is well known that two types of fire occur at the WUI: (1) fires that are small enough for fire departments or possibly homeowners to suppress and thereby protect buildings, and (2) fires that are so large that they overwhelm fire responders, and make it less likely that fire responders can protect buildings. Ideally, suppression effectiveness, *SE*, should be a function of fire size and available fire resources. It is modeled that way for fire following earthquake (Technical Council for Lifeline Earthquake Engineering 2005). It could be done that way in principle for fires at the WUI. It was impractical for United States to process a stochastic set of fires on a national scale within the constraints of the present project. Instead, the project team took burn probability *BP* as a proxy measure of *SE*. The size of fires at the WUI approximately follows a power law (Finney et al. 2011), the exponent of which for California was found to be -1.38. The project team used that value to develop the function  $SE_{BP_i}$ .

## 4.13. ESTIMATING VULNERABILITY

### 4.13.1. Estimating Vulnerability in General

In this part of the Interim Study, the project team used vulnerability in the engineering sense, which means the relationship between a scalar measure of environmental excitation (e.g., momentum flux in the case of flooding in a velocity zone such as a stream or seashore) and a scalar degree of loss (e.g., repair cost as a fraction of replacement cost, new). A vulnerability function refers here to a curve in x-y space where x

measures environmental excitation,  $y$  measures the expected value of loss, and the curve represents the performance of a specified asset class, such as a woodframe single-family dwelling built after 2012. Elsewhere, the Interim Study uses the term vulnerability in its social-science context.

The project team does not use the words vulnerability and fragility interchangeably. As used here, fragility refers to the relationship between environmental excitation and the occurrence probability of some undesirable outcome, such as the collapse of a building. A fragility function refers here to a curve in  $x$ - $y$  space where  $x$  measures environmental excitation,  $y$  measures the occurrence probability of some undesirable outcome, and the curve represents the performance of a specified asset class.

Terminology varies between perils. Some people use the phrases response function, damage function, vulnerability curve, damage curve, and possibly other terms to mean the same thing meant here by vulnerability function. Faced with a choice between using a consistent term across all perils and using numerous terms that may be more familiar to experts within each discipline (fire, flood, wind, etc.), the project team opted for the former choice for consistency.

Some mitigation measures examined here have been well studied and their vulnerability functions developed elsewhere. For example, riverine flood vulnerability (more commonly referred to as depth-damage relationships) is explained in detail in documentation of the Hazus flood module's technical manual (Federal Emergency Management Agency 2011b). Where it is practical to do so, the present Interim Study relies on existing vulnerability relationships and simply refers the interested reader to the relevant documentation, without repeating it here.

In other cases, especially to examine IBHS FORTIFIED Home Hurricane mitigation measures and adoption of the 2015 IWUIC, the project team used existing vulnerability functions as-is or with slight modification, but only after performing some mapping from the features of the mitigation measures to those existing vulnerability functions. In still others, especially designing to exceed I-Code requirements for earthquake loads, neither Hazus nor other resources offer existing vulnerability functions. Transparency requires providing a lot of detail for those cases. As a result of the differences between perils in the availability of vulnerability functions, some of the following sections are short and provide little detail, while some are long.

### **4.13.2. Estimating Riverine Flood Vulnerability**

The project team used the flood vulnerability functions already encoded in Hazus to assess the relationship between flood depth and losses. For details, see the Hazus flood technical manual (Federal Emergency Management Agency 2011b).

### **4.13.3. Estimating Coastal Flooding Vulnerability**

The project team estimated coastal flood vulnerability here using the FEMA BCA re-engineering vulnerability functions that are available within Hazus. The environmental excitation that the vulnerability

functions take as input is flooding depth. The vulnerability function estimates repair costs as output. The flooding depth of a building is taken as the height of stillwater depth with wave height minus the elevation of the first floor, denoted here by  $H$ , which is taken as various heights above BFE. See Equation 4-31. Recall that BFE is calculated using Equation 4-20. The project team did not analyze the cost effectiveness of building above coastal A-zones because these zones are not identified in the NFIP data.

$$D = (\text{NOAA MOMs surge height} + \text{sea level rise}) * 1.55 - H$$

Equation 4-31

The suite of available vulnerability functions differs significantly by wave height because the damage capacity of a wave varies significantly with its size. The estimated height above the BFE is added to the additional height of the structure to determine the vulnerability function used in the equation. The foundation of a coastal home is assumed to be open in all analyses here.

### 4.13.4. Estimating Hurricane Wind Vulnerability

Hurricane wind vulnerability is estimated using the damage functions readily available within Hazus. The project team was interested in the cost effectiveness of constructing new buildings to satisfy the requirements of the IBHS FORTIFIED Home and Commercial Hurricane program, which specifies particular design requirements that in many cases exceed those of the 2015 I-Codes, so one needs to characterize the vulnerability of buildings that satisfy the requirements of IBHS FORTIFIED Home and Commercial. The project team mapped the required building options for each FORTIFIED Home and Commercial designation to the corresponding Hazus damage function parameter, adjusting where necessary. This section describes this process in detail. See Table 4-25 through Table 4-28 for a summary. Certain mitigation measures could not be modeled with existing Hazus damage functions, so damage functions were adjusted either using expert judgment or modified from hurricane mitigation studies.

To calculate the performance improvement associated with each IBHS FORTIFIED Home Hurricane program level (Bronze, Silver or Gold designation), the project team constructed a base-case vulnerability function. The base case reflects a 2,000 sf, single-story, wood-framed single-family dwelling that complies with the 2015 IRC and adheres to all provisions required for hurricane wind resistance. The house has a hip roof and costs \$105 per square foot to build (e.g., not including land). The cost is based on construction estimates provided by the National Association of Home Builders (2015).

Note that in some locations, state and local requirements exceed those of the IRC, such as those adopted after Hurricane Andrew in Miami-Dade or Broward Counties. The project team did not consider these local differences from the IRC, and did not calculate the BCR of exceeding them.

The base case typically remains constant throughout most of the wind speed bands described in Section 4.12.3. Two exceptions: (1) locations where the 700-year wind speed lies between 130-140 mph and the site is within 1 mile of the coastline, and (2) locations where 700-year wind speed exceeds 140 mph. The project team also updated the base case in areas where wind-borne debris would be expected. For

## NATURAL HAZARD MITIGATION SAVES:

regions with 700-year wind speed less than 130 mph, the base-case vulnerability function assumes the following details: roof nailing uses 8d nails at 6"/12"<sup>19</sup>, no secondary water resistance, toe-nail roof-to-wall connections, and openings are not protected. For those homes in regions where 700-year wind speeds exceed 130 mph, the base case assumes the following: roof nailing uses 8d nails at 4"/4", no secondary water resistance, a continuous load path is developed via installation of hurricane straps for roof to wall connections, and openings are protected (where required).

The FORTIFIED Home High-Wind program is applicable for regions where design wind speeds are expected to be less than 115 mph. Because a FORTIFIED Silver dwelling assumes upgrades to gable end bracing and porch connections, this option was not appropriate (e.g., the base case assumes hip roofs and no porch present). Bronze-level upgrades protect the roof system by tightening the roof nailing schedule from 8d at 6"/12" to 8d at 6"/6" and replacing smooth shank nails with ring-shank nails. Secondary water resistance is addressed with both the installation of contouring seam tape and wind-driven water-resistant attic vents. Gold-level upgrades involve reinforcing garages with increased panel bracing plus more rollers with steel axels and wheels, and more brackets for tracks. A continuous load path is developed with the addition of hurricane straps in lieu of roof-wall toe-nail connection. See Table 4-25 [Table 4-25](#) for details and costs.

---

<sup>19</sup> This identifies the nail spacing requirements around the edges and within the interior field.

## NATURAL HAZARD MITIGATION SAVES:

Table 4-25: Hazus modeling of IBHS FORTIFIED Home Hurricane and 2015 IRC for basic wind speed < 115 mph.

		Improvement category	IBHS FORTIFIED	Hazus equivalent	IRC	Hazus equivalent	Est. cost increase for 2,000 sf house
IBHS FORTIFIED Home Designation	Bronze	Roof deck attachment	8d ring-shank @ 6"/6"	8d @ 6"/6"	8d smooth-shank @ 6"/12"	8d @ 6"/12"	\$100
		Secondary water resistance	Yes; roof deck and attic ventilation	Yes	No	No	\$800
	Silver	Opening Protection	Not required				
		Gable end bracing	Strap & block rat-runs	N/A	N/A	N/A	\$500 each
		Porch connections	Enhance resistance to uplift	N/A	N/A	N/A	\$500 each
	Gold	Garage door upgrade	Pressure rated for 140 mph Exposure Category B	Standard	115 mph pressure rated	Weak	\$500 each
		Continuous load path upgrade	Prescriptive requirements avoid specific engineering	Hurricane strap	IRC prescriptive requirements	Toe-nail	1.5% of construction costs

For regions with design wind speeds between 115 and 130 mph, the FORTIFIED Home Hurricane program is available. Bronze upgrades are essentially the same as those described above for basic wind speeds less than 115 mph. Silver upgrades protect openings with installation of wood structural panels. Gold upgrades are the same as those described for wind speeds less than 115 mph. A continuous load path is developed with the addition of hurricane straps in lieu of roof-wall toe-nail connection. See Table 4-26 for details and costs.

**Table 4-26:** Hazus modeling of IBHS FORTIFIED Home Hurricane and 2015 IRC for basic wind speeds of 115-130 mph.

		Improvement category	IBHS FORTIFIED	Hazus equivalent	IRC	Hazus equivalent	Est. cost increase for 2,000 sf house
IBHS FORTIFIED Home Designation	Bronze	Roof deck attachment	8d ring-shank @ 6"/6"	8d @ 6"/6"	8d smooth-shank @ 6"/12"	8d @ 6"/12"	\$175
		Secondary water resistance	Yes; roof deck and attic ventilation	Yes	No	No	\$800
	Silver	Opening Protection	Wood Structural panels	Weak	None	None	\$3,000
		Gable end bracing	Strap & block rat-runs	N/A	N/A	N/A	\$500 each
		Porch connections	Enhance resistance to uplift	N/A	Usually not well anchored against uplift	N/A	\$500 each
	Gold	Garage door upgrade	Pressure rated for local design wind speed	Standard	Probably not rated	Weak	\$500 each
		Continuous load path upgrade	Prescriptive requirements or engineering design	Hurricane strap	Toe-nailed unless load over 200 lbs	Toe-nail	1.5% of construction costs

For regions with basic wind speeds greater than 130 mph and less than 140 mph and more than 1 mile from the coast, the FORTIFIED Home Hurricane program is available. Bronze upgrades add secondary water resistance with both the installation of contouring seam tape and wind-driven water-resistant attic vents. Silver upgrades protect openings with installation of wood structural panels. Gold upgrades are not available since all prescriptive requirements are already required by code. See Table 4-27 for details and costs.

**Table 4-27:** Hazus modeling of IBHS FORTIFIED Home Hurricane and 2015 IRC for basic wind speeds of 130-140 mph and more than 1 mile from coast.

		Improvement category	IBHS FORTIFIED	Hazus equivalent	IRC	Hazus equivalent	Est. cost increase for 2,000 sf house
IBHS FORTIFIED Home Designation	Bronze	Roof deck attachment	8d ring-shank @ 6"/6"	8d @ 6"/6"	8d smooth-shank @ 4"/4"	8d @ 6"/6"	None
		Secondary water resistance	Yes; roof deck and attic ventilation	Yes	No	No	\$800
	Silver	Opening protection	Wood structural panels	Weak	None	None	\$3,000
		Gable end bracing	Strap & block rat-runs	N/A	Strap & block rat-runs	N/A	None
		Porch connections	Designed for local design wind speed	N/A	Designed for local design wind speed	N/A	None
	Gold	Garage door upgrade	Rated for local design wind speed	Standard	Rated for local design wind speed	Standard	None
		Continuous load path upgrade	Prescriptive requirements avoid specific engineering	Hurricane strap	IRC prescriptive requirements	Hurricane strap	None

For regions with design wind speeds greater than 130 mph and less than 1 mile from the coast or wind speeds are greater than 140 mph, the FORTIFIED Home Hurricane program is available. Bronze upgrades are essentially the same as those described above for wind speeds between 130 mph and 140 mph. Silver upgrades improve the opening protection by requiring ASTM/IRC approved impact-rated products. Gold upgrades are not available since all prescriptive requirements are already required by code. See Table 4-28 for details and costs.

The project team estimated costs for the improvements using RSMeans construction cost data and modified them with advice from industry professionals familiar with implemented costs of the IBHS FORTIFIED program. Improvements at the various FORTIFIED levels reflect the additional costs to build above current IRC requirements. Costs are considered modest for such improvements, e.g., replacing smooth shank nails with ring shank nails for roof sheathing attachments costs approximately \$100. Taping seams for secondary water resistance costs approximately \$800.



## NATURAL HAZARD MITIGATION SAVES:

**Table 4-28:** Hazus modeling of IBHS FORTIFIED Home Hurricane and 2015 IRC for basic wind speed at least 130 mph and less than 1 mile from coast, or based wind speed at least 140 mph regardless of coastal distance.

		Improvement category	IBHS FORTIFIED	Hazus equivalent	IRC	Hazus equivalent	Est. cost increase for 2,000 sf house
IBHS FORTIFIED Home Designation	Bronze	Roof deck attachment	8d ring-shank @ 6"/6" or tighter spacing	8d @ 6"/6"	8d or larger smooth-shank @ 4"/4"	8d @ 6"/6"	None
		Secondary water resistance	Yes; roof deck and attic ventilation	Yes	No	No	\$800
	Silver	Opening protection	ASTM/IRC approved impact-rated product	Standard	Code minimum is wood structural panels	Weak	\$4,000
		Gable end bracing	Strap & block rat-runs	N/A	Strap & block rat-runs	N/A	None
		Porch connections	Designed for local design wind speed	N/A	Designed for local design wind speed	N/A	None
	Gold	Garage door upgrade	Rated for local design wind speed	Standard	Rated for local design wind speed	Standard	None
		Continuous load path upgrade	Prescriptive requirements avoid specific engineering	Hurricane strap	IRC prescriptive requirements	Hurricane strap	None

Some vulnerability effects of IBHS FORTIFIED Home Hurricane requirements cannot be modeled with the existing Hazus, such as replacing smooth-shank with ring-shank nails for the roof diaphragm nailing. The project team estimated, with input from industry professionals, a 5% reduction in repair cost, based on the increased uplift resistance of the roof diaphragm. Nor can Hazus model installation of wood structural panels for opening protection, as in the FORTIFIED Silver program. A modified damage function was generated using the *2008 Florida Residential Wind Loss Mitigation Study* by Applied Research Associates (2008), which provides relative loss values from no shutter to basic, plywood or oriented strand board (OSB) shutters. Protecting openings with wood structural panels reduces repair costs by approximately 22% relative to the base case.

## NATURAL HAZARD MITIGATION SAVES:

To estimate BCRs associated with improvements afforded by the IBHS FORTIFIED Commercial Hurricane Program, the project team adopted the approach used in the IBHS FORTIFIED Residential Program. To calculate the performance improvement associated with each program level (Bronze, Silver or Gold designation), the team constructed a base-case vulnerability function for each model building type (i.e., the base case refers to current code). The three models were: 1) a reinforced masonry, low-rise hotel/motel with a flat, EPDM roof with wood-framed roof trusses, 2) a reinforced masonry, low-rise strip mall with a flat, EPDM roof with wood-framed roof trusses, and 3) a reinforced masonry, low-rise strip mall with open web steel joists and a metal roof deck. The configuration and area opening information was taken directly from the HAZUS Hurricane technical manual. The project team chose the strip mall (OWSJ and wood-framed trusses) and hotel/motel (wood-framed trusses) for this analysis for several reasons: 1) these types represent a large portion of the building population that fall under the description of commercial construction (in terms of number) and 2) the options for modeling different construction conditions were highest within the context of using HAZUS as the basis of calculating building damage and loss. Although this provides a limited characterization of building structures in the commercial category, it does allow the team to capture all of the primary deficiencies that result in structural damage from extreme wind effects. The HAZUS mitigation options for each of the model building types include:

- Hotel/motel: roof sheathing nailing schedule, roof cover “quality”, roof to wall connection, opening protection;
- Strip mall wood truss: roof sheathing nailing schedule, roof to wall connection, opening protection;
- Strip mall OWSJ: roof age, opening protection

The remaining HAZUS model types for low-rise, commercial buildings include reinforced concrete engineered buildings, steel-framed engineered buildings and reinforced masonry engineered buildings. These were excluded from the analysis simply because of the limited number of modeling options available in HAZUS.

As noted previously, in some locations, state and local building requirements exceed those of the IBC, e.g., Miami-Dade or Broward Counties, post Hurricane Andrew. The project team did not address how these local differences would compare with the IBC and did not calculate the BCR of exceeding them.

The mitigation option chosen for both the base case (current code) and IBHS FORTIFIED Commercial for each model building type was established by satisfying the following qualifications:

- *Are the resistance values for each mitigation option greater than the design pressures calculated?* For every mitigation option, the HAZUS Technical Manual identifies the resistance values assumed for the model. For example, if the model building type has wood trusses and a wood diaphragm, the project team identifies whether the 8d @ 6”/12” nailing schedule can satisfy the design pressures calculated at the 115 mph wind contour? If the answer is yes, the 8d @ 6”/12” nailing schedule is chosen. *Can the resistance values satisfy the design pressures calculated at the 150 mph wind contour?* If the answer is no, the resistance values of the next mitigation option (8d @ 6”/6” nailing schedule) is checked. This

## NATURAL HAZARD MITIGATION SAVES:

process is repeated for all wind contours, and for all mitigation options that would be designed based on the roof pressures calculated.

- The project team then checks to see if the mitigation option is allowable per current I-Codes. For example, a 6d @ 6"/12" roof nailing schedule may satisfy the capacity/design requirements for some of the lower wind bands, however, current code may require 8d minimum nailing, therefore the 8d nailing option is chosen. Additional prescriptive code requirements such as opening protection where the basic wind speed is either 1) greater than 130 mph and less than a mile from the coast or 2) greater than 140 mph, are also checked and reflected in the modeling.
- Finally the project team identifies whether the HAZUS mitigation option selected is appropriate for the structure being modeled. For example, the option of "old" roof for the OWSJ strip mall is not be used for current or IBHS FORTIFIED Commercial construction. Although the resistance values of the "old" roof may satisfy the design requirements for newer construction in the lower wind bands, this option was never chosen.

Due to the limitations of HAZUS (modeling and parameter selection), some mitigation requirements by IBHS could not be appropriately modeled. This was particularly true regarding the IBHS FORTIFIED Commercial Bronze program where higher design pressures for roof components and connections are required. In situations where a modeling option was not available in the HAZUS database, the fragility curve was "shifted" to reflect the respective design conditions of the structure being modeled. This was achieved by first establishing the fragility model for the current code baseline. This typically included the HAZUS mitigation options associated with the highest resistance values (although there were a few exceptions such as the roof nailing schedule). The same fragility function was then re-plotted, this time using the next lowest option (second highest resistance value). The percent decrease in each damage ratio for each wind speed (50, 55, 60,... 200mph) was recorded. Referring back to the HAZUS technical manual, this decrease was then associated with the decrease in the listed resistance values used to develop the model. Since IBHS requires a 1.67 minimum factor of safety for roof ASD design wind loads for the FORTIFIED Commercial Bronze program, an adjustment ratio (given the ratio of both HAZUS resistance values and ASCE 7-16/IBHS design pressures) was then applied to the existing damage curve to construct a modified damage curve for construction adhering to the IBHS requirements.

Additionally, both the IBHS FORTIFIED Commercial Silver and Gold programs require backup power, via a transfer switch or docking station (silver) or on-site backup power (gold). Since HAZUS does not offer a mitigation option for accessible backup power, the project team addressed this issue by adopting expected downtime loss curves (days) available within HAZUS and assuming that any downtime would be minimized by having access to back-up power. Given that the estimated downtime is directly related to the expected building damage (as modeled within HAZUS), the calculated downtime for both the IBHS silver (enhanced roof design and envelope protection) and gold (enhanced roof design, envelop protection and continuous load paths) programs are less than the base case (current code). For IBHS FORTIFIED Commercial gold, the project team assumed all downtime is mitigated by the presence of the onsite backup generator. For IBHS FORTIFIED Commercial silver, the project team assumed a two day

## NATURAL HAZARD MITIGATION SAVES:

window for a backup generator to be brought on site. The remaining days of downtime are assumed to be mitigated by the backup power.

Replacement cost estimates were provided by IBHS, which are based on the RSMeans construction cost manual. The IBHS spreadsheet identifies estimated costs for current construction and costs for the various IBHS FORTIFIED mitigation options (increased roof resistance, opening protection via hurricane shutters, engineered structures via continuous load paths, etc.).

Some limitations of this approach to estimating wind vulnerability:

1. Special inspection requirements. Special inspection is now required in the following hurricane wind regions: (a) In wind Exposure Category B, where  $V_{asd}$  as determined in accordance with Section 1609.3.1 is 120 miles per hour (52.8 m/sec) or greater. (b) In wind Exposure Category C or D, where  $V_{asd}$  as determined in accordance with Section 1609.3.1 is 110 mph (49 m/sec) or greater.
2. Mechanical equipment. Increased wind design (horizontal and uplift loads) for rooftop mechanical equipment.
3. Roof shingles and tiles. Increased performance of roof shingles/tiles connection in hurricane wind (ASTM standards classes G and H).
4. Main wind force resisting system. Strengthened shear walls, frames, or both from higher design wind loads are not modeled with current Hazus vulnerability functions.
5. General. The analysis of code compliance assumes construction is compliant with codes circa 1990. For some of the hurricane prone regions considered in the analysis, building codes may not have been adopted or completely enforced. As a result, a baseline of early 1990's construction may be optimistic, as actual construction may be reflective of older codes.
6. Wind borne debris. Increased performance of wind protection requirements.
7. General. Improvements to the full load path are not considered. This is perhaps the most significant limitation given the changes to the building code.

### 4.13.5. Estimating Seismic Vulnerability

The project team considered several options for estimating seismic vulnerability. (See Table 4-29.) In light of the advantages and disadvantages, the project team opted to use the modified Hazus vulnerability approach for repair cost, casualties, and downtime. The Hazus vulnerability approach addresses both structural and nonstructural vulnerability, and recognizes that increased stiffness can aggravate damage to acceleration-sensitive nonstructural components. Note that in many locations, particularly in the CEUS, wind design may govern the lateral strength of many buildings. Increases in seismic design requirements may not increase the design strength or the construction cost of the building, nor produce the benefits one estimates based on seismic design requirements alone. In these cases, the costs and benefits would not apply. The project team did not attempt to identify locations where wind design governs or remove the costs and benefits from the overall calculation. Since the states with the highest seismic risk, and therefore where seismic-responsive design is required, contribute the vast majority of the costs and

## NATURAL HAZARD MITIGATION SAVES:

benefits of seismic design to exceed I-Code requirements, the project team felt the benefits and costs in this situation would be minimal.

For an overview of the project’s approach for repair costs, casualties, and duration of loss of function, see Porter (2009a, b). For evidence about the cost to exceed 2015 I-Code requirements see Porter (2016a), which examines the cost from several different perspectives. See Appendix K of the Interim Study for the fine details of how the project team applied those three works to the problem of calculating the vulnerability of code-level and above-code buildings designed for site-specific seismic hazard, and how the project team applied those vulnerability functions to an estimated inventory of present-day buildings across the 48 contiguous United States.

The project team considered various levels of detail for presenting BCR, including: by census block, tract, county, state, or national level; or by model building type and occupancy, model building type alone, occupancy alone, or at some aggregate level. It seemed practical and desirable to provide geographic detail, but providing detail both by geographic area and by some subgroup of buildings (either model building type, occupancy category, or both) would overwhelm readers. The project team opted to provide BCRs for the aggregate building stock of ordinary buildings (Risk Category II) at the county level, which readers could readily discern in printed maps. As a result, the averages produced here may overestimate BCR for some occupancies and building types, and underestimate them for others.

The project team acknowledged the limitations of the selected approach, but it is practical and consistent with FEMA’s own preferred tools for BCA of earthquake risk mitigation: Hazus and the FEMA BCA Tool. The combination of FEMA P-58 and the GEM is impractical for present purposes.

**Table 4-29:** Selection of method to estimate seismic vulnerability.

Option	Advantages	Disadvantages
Hazus high code (for Risk Category II) and special high code (Risk Category IV) (Porter 2009a, 2009b)	Well documented, fairly authoritative, nearly exhaustive	Inconsistent with ASCE 7-10 collapse fragility model. San Francisco CAPSS project (Porter 2012) shows highly uncertain assumptions are required to map Hazus damage states to ATC-20-1 (Applied Technology Council 2005) tag color. Hazus stiffness for special high code is equal to high code, whereas greater strength is probably accompanied by greater stiffness. Does not reflect site-specific seismic hazard.
Modified Hazus: apply Hazus math but with $C_s$ based on design for site-specific hazard and $R$ based on model building types of recent vintage.	Leverages advantages of Hazus approach while better reflecting loss reduction resulting from greater strength and stiffness. Reflects site-specific hazard. Practical at national scale.	Capacity spectrum method is old technology and can yield inaccurate results for the performance point, especially for low-rise construction.

## NATURAL HAZARD MITIGATION SAVES:

Tabulate per Porter (2009a, 2009b)		
Commercial catastrophe risk models, e.g., RMS, AIR, Core Logic	Accepted by insurance industry, substantial empirical basis for building categories that were present and insured in large numbers in California in 1989 and 1994.	Proprietary; not peer reviewed; scant or no empirical basis for functions for U.S. buildings other than California construction present and insured in large numbers in 1989 and 1994; based on insured buildings and therefore possibly biased. No basis for designing to exceed I-Code requirements. Might not reflect site-specific seismic hazard.
ASCE-7-based collapse, red-tag, and yellow-tag fragility functions (Porter 2016)	Uses collapse fragility model underlying ASCE 7-10; strong empirical basis for red- and yellow-tagging as multiples of collapses. Treats site-specific seismic hazard.	No model of repair cost, casualties, or repair duration.
PBEE-2 (FEMA P-58; Applied Technology Council 2012)	State of the art for single buildings.	Does not treat building classes. Impractical at national scale. See Box 4-2 for more discussion.
Global Earthquake Model (GEM) analytical approach (Porter et al. 2015), using SP3 for efficiency	General applicability for repair cost	Time consuming; requires survey of relevant attributes in many geographic regions; requires constructing (at least simplified) FEMA P-58 models of 1, 3, or 7 samples of every building type in each geographic region. Never exercised for downtime or casualties. See Box 4-2.

Despite the references to Porter (2009a, b, and 2016a), the project team also provided a brief summary of the Hazus vulnerability methodology. A building is idealized as a single-degree-of-freedom nonlinear harmonic oscillator with an elastic-softening-perfectly-plastic pushover curve. The capacity-spectrum method of structural analysis is used to estimate the acceleration and displacement of the building, as illustrated in Figure 4-23. In the figure, the capacity curve represents the relationship between displacement and acceleration of the building over a range of ground motions. The input spectrum idealizes the excitation that an earthquake of a given magnitude, distance, and region imposes on undamaged buildings. The demand spectrum idealizes the excitation that the earthquake imposes on damaged buildings. The performance point represents an estimate of the displacement and acceleration that the earthquake imposes on the particular building with the given capacity curve.

The estimated structural response (the acceleration and displacement of the oscillator at the performance point) is input to a set of fragility functions that produce an estimate of probabilistic damage to three generalized building components: structural, non-structural drift-sensitive, and non-structural acceleration-sensitive components. Then estimate loss, in each of several measures, especially (1) repair costs as a

## NATURAL HAZARD MITIGATION SAVES:

function of the damage, (2) fatal and nonfatal injuries, and (3) loss-of-use duration. The estimate of repair costs depends on the probabilistic damage state of the three components and the cost to repair the damage from each possible damage state for each component. Repair costs also depend on the building occupancy, because the relative value of the three components varies between occupancy classes. The estimates of injuries and restoration time depend only on the structural damage. Appendix K provides details of the methodology.

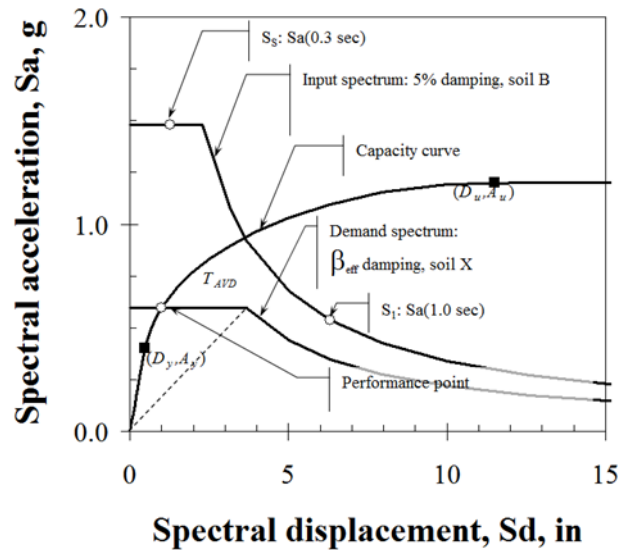

Figure 4-23: Capacity spectrum method of structural analysis.

**Box 4-2. Using Hazus Rather than FEMA P-58 and GEM to Assess the Cost-Effectiveness of Designing to Exceed I-Code Requirements for Earthquake**

Some structural engineers strongly endorse FEMA P-58 (Federal Emergency Management Agency 2012d) and criticize the capacity-spectrum method of structural analysis employed by Hazus. In the project team’s opinion, FEMA P-58 produces more-credible vulnerability functions for individual buildings than does a Hazus-based approach. Project team members helped to lead development of FEMA P-58 and its underlying theoretical basis and initial case studies (e.g., Porter, 2000, Porter, 2003, Krawinkler et al., 2005). However, FEMA P-58 is building-specific. It does not produce vulnerability functions that apply to a building class.

One can use the GEM analytical methodology (Porter et al., 2014) to design probabilistically representative specimens of a building class and analyze them with FEMA P-58 to construct vulnerability functions for a building class. The resulting vulnerability functions are probably more credible than those produced by a Hazus-based approach.

However, practicality forbids the use of the GEM methodology as well. To create a single defensible FEMA P-58 vulnerability function can take hours, days, or more, depending on how much simplification one accepts in the structural modeling. To create a vulnerability function for a building type using the GEM analytical methodology requires between 1 and 7 vulnerability functions created using FEMA P-58. The proper selection of the engineering attributes of those 1 to 7 buildings (number of stories, degree of vertical irregularity, etc.) requires observation and statistical combination of hundreds of real buildings. Nobody has compiled those statistics for the U.S. building stock. Project team members have found by actual practice that compiling those statistics takes tens or hundreds of labor-hours per building type.

Depending on how much detail one wants, the inventory of U.S. buildings includes at least dozens of combinations of building type and height category. Hazus for example categorizes the building stock in 1,008 combinations of model building type, height category, and occupancy class, each of which would require statistics on height and irregularities, and each of which would require 1 to 7 FEMA P-58 models. Each such combination must be designed and analyzed for each of many levels of  $MCE_R$  motion and each of many levels of strength and stiffness ( $I_e$ )—on the order of 5 to 10 of each, meaning that a GEM approach, using FEMA P-58, would require design and analysis of between 100,000 and 700,000 buildings.

Thus, to create reasonably defensible vulnerability functions for perhaps 700,000 combinations of model building type, height category, occupancy class,  $S_5$  or  $S_1$  level, and  $I_e$ , would take millions of labor hours, at least as the task is conceived here. No superior, less time-consuming approach appears to exist. By contrast, the Hazus-based approach can be entirely automated using existing math and parameter values. Furthermore, a Hazus-based approach is consistent with FEMA BCA. The Hazus approach has its disadvantages, such as its reliance on the capacity spectrum method (see Table 4-29), but it seems to be a practical, albeit imperfect, solution. FEMA P-58 and GEM by contrast may be excellent solutions, but are impractical for this problem.



### 4.13.6. Estimating Fire Vulnerability

Understanding the vulnerability of buildings to fire has been the subject of much work. Researchers generally treat building ignition from external fires as resulting from one or more of several phenomena: heat radiation, convection, or conduction (the last cause being less significant). Real buildings ignite by heat build-up, which causes a temperature rise of exposed cladding, roofing, and contents. Buildings also ignite because flames impinge on the building and because of convection of hot gases from the external fire. Firebrands also cause ignitions: burning pieces of wood, carried aloft by hot gases, land on and ignite the roof, debris-filled gutters, or other parts of the building. Many researchers have studied firebrands in WUI fires (e.g., Koo et al., 2010; Manzello et al., 2005, 2006a, 2006b; Pagni and Woycheese, 2000), but still have difficulty quantifying their effects (Mell et al., 2009).

One can employ principles of heat transfer and fire-protection engineering to assess how quickly and in what way a particular, well-specified building or its furnishings is likely to ignite under fire attack, and how quickly fire will spread (Cohen, 1995; Drysdale, 1999; Himoto and Tanaka, 2008; Quintiere, 1998). These approaches are difficult to impractical to apply to the present project, which deals with large numbers of buildings with widely varying designs and without building-specific information (Lee et al., 2008).

The other alternative to estimate inter-building fire spread at the urban or WUI scale is to use empirical or expert-opinion models (Gollner et al. 2015; Hakes et al. 2017). The project team used that approach for practical reasons.

The project team estimated two cases of the fire vulnerability of a prototype building: 1) not compliant with the 2015 IWUIC and 2) compliant. Both represent a single-family wood-framed dwelling. The non-compliant building is assumed to be wood framed with combustible (e.g., wood) cladding and roofing; no automatic sprinklers; no underfloor enclosure; non-fire rated single-pane glazing and doors; unprotected eaves, soffits, and gutters; and unmanaged nearby fuels (trees, bushes, duff, accumulated dead natural fuels, firewood, and accumulated other combustible material and outbuildings) close to the building. Access may be problematic for fire vehicles and water supply may be inadequate for structural firefighting.

The compliant building is like the non-compliant building, except that it meets the requirements of the 2015 IWUIC. In summary, requirements of the 2015 IWUIC depend on the fire hazard severity and may include: non-combustible roofing material; fire-rated cladding; automatic sprinklers; underfloor and underdeck fire-rated enclosure; fire-rated glazing and exterior doors; non-combustible or protected gutters; non-combustible or protected eaves and soffits; and a defensible space created within a fuel modification distance from the structure, in which one must remove or manage trees, bushes, litter, duff, accumulated dead natural fuels, firewood, and accumulated other combustible material and outbuildings.

Fire experts use the term “response function” to mean what in the Interim Study is termed a “vulnerability function.” Thompson et al. (2011) offer a number of response functions for various non-building assets and one class of building asset, which is labeled “cabin.” The Thompson response functions for WUI fire risk were created using expert opinion and relate loss to flame length. The project team applied expert

judgment and data on fire spread (Technical Council for Lifeline Earthquake Engineering 2005) to modify the response function for cabins. The modifications represent the non-compliant and compliant buildings.

### 4.14. ESTIMATING PROPERTY REPAIR COST AND REPAIR DURATION

Property repair for a building or other asset subjected to excitation  $x$  is calculated as shown in Equation 4-32, where  $L(x)$  is the property repair cost,  $j$  is an index to categories of property at the asset location (generally building, contents, or business stock),  $V_j$  is the value of one category of property at the asset, and  $y_j(x)$  is the mean vulnerability function of that category of property evaluated at excitation  $x$ .

$$L(x) = V_j \cdot y_j(x)$$

Equation 4-32

The vulnerability functions for buildings produce as an intermediate product the probability  $P_d(x)$  of various building damage states  $d$  occurring when the building is subjected to excitation  $x$ . Each damage state  $d$  is associated with a best estimate of the time required to repair the building from that damage state, denoted by  $t_d$ . The estimated repair duration is then calculated using the theorem of total probability, which states that the expected repair duration  $t(x)$  is the sum of the products of  $P_d(x)$  and  $t_d$ , summed over the number of possible damage states, denoted here by  $N_d$ . Equation 4-33 presents the calculation.

$$t(x) = \sum_{d=1}^{N_d} t_d \cdot P_d(x)$$

Equation 4-33

### 4.15. RESIDENTIAL DISPLACEMENT COST (ADDITIONAL LIVING EXPENSES)

Residential displacement costs (which insurers call ALE) are a function of displacement time or the length of time a residential structure is uninhabitable due to damage and costs related to the displacement. Housing costs are \$1,500 per month for the length of displacement. Average rent in the United States according to the USCB is \$900; the analysis assumes \$1,500 to account for higher costs as a result of housing market shifts or some households staying at hotels or other types of shelters, including short-term public sheltering or long-term provision of mobile homes post-disaster. Adding \$500/month for furniture rental and \$100 per month for increased commuting costs produces a total monthly displacement cost of \$2,100 per household. One can convert \$2,100 per month per family to a daily cost per person by taking 1 month = 30.4 days (on average) and the average household size as 2.5 people. Thus, residential displacement can be estimated as  $(\$2,100 \text{ per household per month}) / (30.4 \text{ days per month}) / (2.5 \text{ people per household}) = \$28 \text{ per person per day}$ . Daily displacement cost for a household is  $(\$2,100 \text{ per household per month}) / (30.4 \text{ days per month}) = \$69 \text{ per household per day}$ .

## 4.16. ESTIMATING BUSINESS INTERRUPTION LOSS

Consequences from natural or human-caused hazards, such as earthquakes, flooding, severe storms, droughts, terrorist attacks, industrial accidents, etc. include: damage (and direct disruptions) to physical and human capital (e.g., stock losses), and direct and indirect BIs, causing the loss of production and consumption (e.g., flow losses). Several studies have estimated total BI losses from disasters to be economically costlier than the direct losses, in cases such as 9/11 and Hurricane Katrina.

This project applies IO modeling for estimating indirect BI losses in the aftermath of disasters. An IO model is based on a tabulation of all purchases and sales in a given year between sectors of an economy and an assumption of a proportional relationship between inputs and outputs (Rose and Miernyk 1989). One of the strengths of the IO model is that it is supported by detailed data collected and compiled by national census and statistical agencies. In the United States, for example, extensive IO data are published by the BEA to generate the technical coefficient matrix that represents the proportional relationship between inputs and outputs (Miller and Blair 2009). This methodology is coupled with BEA's Regional Input-Output Multiplier System to provide a useful framework for evaluating economic interdependencies (U.S. Department of Commerce, 1997). These data are available from the BEA for the nation as a whole, each state, metropolitan regions (using the U.S. Census definitions), and counties. The availability of economic data enables the application of IO model and its hybrids for analysis of relatively small regions, e.g., infrastructure disruptions in Portland (Rose and Liao 2005).

Within the domain of IO modeling, the concept of inoperability has been used in recent studies to determine the direct and indirect economic losses in the aftermath of losses. Haimés and Jiang (2001) revisited the Leontief model and expanded it to account for inoperability, or the inability for sectors to meet demand for their output. The inoperability measure is a dimensionless number between 0 (ideal state) and 1 (total failure); and, as such, it is interpreted as the proportional extent in which a system is not functioning relative to its ideal state. Examples of studies that implemented Inoperability IO Model (IIM) to estimate economic losses include terrorism (Santos and Haimés 2004), electric power blackouts (Anderson et al. 2007), disease pandemics (Orsi and Santos 2010), and hurricane scenarios (Resurrección and Santos 2013), among others.

Three general categories of data requirements that enable the implementation of the IIM are: (1) regional/geographic scope of the disaster, (2) extent to which the region is affected (e.g., scale of 0-100%), and (3) recovery period. The parameter descriptions of the IIM, as well as additional discussion on the dynamic model extensions, follow. Details of model derivation and an extensive discussion of model components are found in Santos and Haimés (2004) and also in Santos et al. (2008).

### 4.16.1. Model Parameters

The IIM is structurally similar to the classical IO model. The mathematical formulation is as follows:

$$q = A^*q + c^*$$

Equation 4-34

Where,

$q$  = the inoperability vector (e.g., the element,  $q_i$ , denotes the inoperability of sector  $i$ )

$A^*$  = the interdependency matrix (e.g., the element  $A^*_{ij}$  denotes the input requirement of sector  $j$  that comes sector  $i$ , normalized with respect to the total input requirements of sector  $j$ )

$c^*$  = the demand perturbation vector (e.g., the element,  $c^*_i$ , denotes the demand perturbation to sector  $i$ )

### 4.16.2. Sector Inoperability

Inoperability is conceptually related to the term unreliability, which expresses the ratio with which a sector's production is degraded relative to some ideal or 'as-planned' production level. Sector inoperability ( $q$ ) is an array comprised of multiple interdependent economic sectors. The inoperability of each sector represents the ratio of unrealized production (e.g., ideal production minus degraded production) relative to the ideal production level of the industry sectors. To understand the concept of inoperability, suppose that a given sector's ideal production output is worth \$100. Suppose also that a natural disaster causes this sector's output to reduce to \$90. The production loss is \$10, which is 10% of the ideal production output. Hence, the inoperability of the sector is 0.10. Since a region is comprised of interacting sectors, the value of inoperability will further increase due to the subsequent ripple effects caused by sector interdependencies.

### 4.16.3. Interdependency Matrix

The interdependency matrix ( $A^*$ ) is a transformation of the Leontief technical coefficient matrix ( $A$ ), which is published by BEA and publicly available (Bureau of Economic Analysis 2016). It is a square matrix with equal rows and columns, which correspond to the number of industry sectors. The elements in a particular row of the interdependency matrix can tell how much additional inoperability is contributed by a column industry sector to the row industry sector. When the interdependency matrix ( $A^*$ ) is multiplied with the sector inoperability ( $q$ ), this will generate the intermediate inoperability due to endogenous sector transactions. Endogenous transactions in the context of the Interim Study pertain to the flow of intermediate commodities and services within the intermediate sectors. These endogenous commodities and services are further processed by the intermediate sectors (e.g., commodities and services that are not further transformed or those used immediately for final consumption are excluded from endogenous transactions). The BEA has detailed IO matrices that can be customized for desired geographic resolutions using regional multipliers, or location quotients based on sector-specific economic data. This process of regionalization is performed to generate region-specific interdependency matrices.

#### 4.16.4. Demand Perturbation

The demand perturbation ( $c^*$ ) is a vector comprising of final demand disruptions to each sector in the region. The demand perturbation, just like the inoperability variable in the IIM formulation, is normalized between 0 and 1. In this basic IIM formulation, supply disruptions are modeled as “forced” demand reductions. Consider a hypothetical disruption where the supply for a commodity or service decreases but demand remains virtually unaffected. In this case, the consumers will have to temporarily sacrifice their need for that commodity or service until it bounces back to its as planned supply level. The limitation of the basic IIM formulation is that it uses “forced” demand reduction as a surrogate to supply reduction. To address this shortcoming, the dynamic extension to the IIM was developed to enable a more explicit definition of perturbation parameters, in addition to the formulation of a sector-specific economic resilience matrix.<sup>20</sup>

#### 4.16.5. Economic Resilience

A key motivation that led to the development of the dynamic IIM is the need for linking the concept of economic resilience with time-varying sector inoperability for a given recovery horizon. In general, resilience is defined as the ability or capability of a sector to absorb or cushion against damage or loss and rebound to the original state (Holling, 1973, Perrings, 2001). Rose and Liao (2005) suggest that *static* resilience can be enhanced through using existing resources as efficiently as possible, such as: 1) expedited restoration of the damaged capability; 2) using an existing back-up capability; 3) conservation of inputs to compensate for supply shortfalls; 4) substitution of inputs; or 5) shifting of production locations, among others; and that *dynamic* resilience is expedited through restoration of the damaged capability. Rose (2009) provides comprehensive definitions and categories of economic resilience including static, dynamic, inherent, and adaptive.

The dynamic formulation of the IIM takes into account the economic resilience of each sector, which influences the pace of recovery of the interdependent sectors in the aftermath of a disaster. The formulation is as follows:

$$q(t+1) = q(t) + K[A^*q(t) + c^*(t) - q(t)]$$

Equation 4-35

The term K is a sector resilience coefficient matrix that represents the rates at which sectors recover to their nominal levels of production following a disruption (Lian and Haines 2006). The model dictates that the inoperability level at the following time step,  $q(t+1)$ , is equal to the inoperability at the previous stage,  $q(t)$ , plus the effects of the resilience of the sector. The values of K tend to be negative or zero, thereby detracting from the overall level of inoperability. As seen in the above equation, K is multiplied with the

---

<sup>20</sup> Economic resilience can be defined in many ways, here it refers to the ability to recover from the negative impacts of external economic shocks resulting from natural hazards.

indirect inoperability resulting from other sectors,  $A^*q(t)$ , plus the degraded final demand,  $c^*(t)$ , minus the current level of inoperability,  $q(t)$ . The resilience coefficient,  $K$ , is assumed to be an inherent characteristic of a particular sector, but multiplying it with the inoperability product term,  $A^*q(t)$ , will result in coupled resilience across directly related sectors. This is particularly relevant when analyzing a sector that heavily depends on another sector for achieving its as-planned productivity levels. Regardless of how inherently resilient a sector is, its productivity will be significantly compromised when another sector it heavily depends on becomes largely inoperable in the aftermath of a disaster.

The dynamic extension answers one of the fundamental limitations of the basic IIM, which is the ability to capture time-varying recovery that adapts to some level of reasoning and current levels of inoperability within the perturbation and recovery period. For the dynamic extension to the IIM, Lian and Haines (2006) provide the formulation to estimate the sector resilience coefficient of each sector. This resilience coefficient is a function of: 1) sector inoperability; 2) sector interdependencies; 3) recovery period; and 4) the desired level of inoperability reduction for the target recovery period. In this economic resilience formulation, economic resilience is inversely proportional to the recovery period. This is because resilience is a desired attribute of any system and, hence, a higher level of resilience is preferred. On the other hand, recovery period (e.g., the time it takes to reach full recovery) is desired to be at minimum to the extent possible. The higher the value of the sector resilience metric, the better equipped it is to protect and recover itself from external perturbations. Hence, increasing the economic resilience metric of a sector reduces its recovery period as well as the associated economic losses. The dynamic version of the IIM is capable of analyzing the extent to which sector resilience can decrease the magnitude of sector inoperabilities and economic losses, as well as shorten the recovery period. This formulation would create a time-dependent value to better account for the impact of different intensities and durations of a disaster, as longer ones would tend to further stress the sectors, adding to the BI losses and impacting their ability to recover. Lian et al. (2007), Santos (2006), Lian and Haines (2006), and Haines et al. (2005) applied the model to various regional disaster scenarios to analyze the recovery behaviors of critical economic sectors and infrastructure systems.

### 4.16.6. Economic Loss

Similar to sector inoperability, economic loss is an array comprised of multiple interdependent economic sectors. Each element in this array indicates the magnitude of economic (BI) loss of each sector, in monetary units (or particularly in U.S. dollars for the scenarios to be explored in the case studies). The economic loss of each sector is simply the product of the sector inoperability and the ideal production output. For example, an inoperability of 0.1 for a sector where production output is \$100 will result in an economic (or production) loss of \$10. Economic loss, in terms of decreased production or output, is treated as a separate disaster metric since it complements the inoperability metric. Both the inoperability and economic loss metrics are desired to be kept at minimum. It is also worth noting that when the sectors are ranked according to the magnitude of their inoperability and economic loss metrics, two distinct rankings will be generated. Suppose that a second sector has an inoperability of 0.2 and a production output of \$40. The resulting economic loss will be  $0.2 \times \$40 = \$8$ . Although the inoperability of the second

sector (0.2) has a higher rank compared to the first sector (0.1), the direction of priority will reverse when economic loss is considered as the sole basis for ranking. Thus, the second sector has an economic loss of \$8, which has a lower rank in contrast to the first sector’s \$10 economic loss.

### 4.16.7. Relating Hazus Results with IO Assessment of Indirect Business Interruption

The Interim Study uses the results from various Hazus scenarios as inputs to assess the indirect BI losses. Disasters are expected to cause damage to various Hazus building occupancy classes. Hazus uses 33 building-occupancy classes categorized according to residential, commercial, industrial, religion/non-profit, educational, and government (28 if one ignores the differences between classes 3 through 8). See Table 4-30 for the Hazus occupancy classes.

**Table 4-30:** Hazus building occupancy classes (Federal Emergency Management Agency 2012).

No.	Label	Occupancy class	Description
Residential			
1	RES1	Single-family dwelling	Detached house
2	RES2	Mobile home	Mobile home
3-8	RES3a-f	Multi-family dwelling	Apartment or condominium
9	RES4	Temporary lodging	Hotel/motel
10	RES5	Institutional dormitory	Group housing (military, college), jail
11	RES6	Nursing home	
Commercial			
12	COM1	Retail trade	Store
13	COM2	Wholesale trade	Warehouse
14	COM3	Personal and repair services	Service station/shop
15	COM4	Professional, technical services	Offices
16	COM5	Banks and financial institutions	
17	COM6	Hospital	
18	COM7	Medical office or clinic	Offices
19	COM8	Entertainment & recreation	Restaurants and bars
20	COM9	Theaters	Theaters
21	COM10	Parking	Garages
Industrial			
22	IND1	Heavy industry	Factory
23	IND2	Light industry	Factory

## NATURAL HAZARD MITIGATION SAVES:

No.	Label	Occupancy class	Description
24	IND3	Food, drugs, chemicals	Factory
25	IND4	Metals, minerals processing	Factory
26	IND5	High technology	Factory
27	IND6	Construction	Office
Agriculture			
28	AGR1	Agriculture	
Religion/non-profit			
29	REL1	Church	
Government			
30	GOV1	General services	Office
31	GOV2	Emergency response	Police or fire station
Education			
32	EDU1	Schools	
33	EDU2	Colleges and universities	Does not include group housing

For a particular disaster scenario, Hazus estimates several categories of losses (e.g., structural building loss, non-structural building loss, content loss, inventory loss, relocation loss, income loss, rent loss, and wage loss) in each occupancy class, expressed in annualized dollar loss. Nonetheless, it is important to extract only the direct BI (or direct flow) losses as inputs to the IO model. In subsequent discussions, the term *direct BI loss* refers to applicable direct flow loss categories (e.g., income loss, rent loss, and wage loss), while *indirect BI losses* represents the additional losses after the IO model is implemented.

From the perspective of IO modeling, the direct BI losses that can be extracted from Hazus will be interpreted as the direct flow loss to a particular building occupancy class, which further creates ripple effects to other business sectors due to their inherent interdependencies. Hence, in estimating the indirect BI losses, it is necessary to relate such occupancy classes with the equivalent economic sectors as used in the IO model. The first column of Table 4-31 contains the sector code created for the purpose of the Interim Study. The second column corresponds to the scope of the equivalent IO sectors as interpreted in a similar fashion as the annual IO accounts by the BEA. Finally, the last column of the table below contains the standard Hazus building occupancy class as described in previous sections of the Interim Study.



Table 4-31: Relating IO sectors with Hazus occupancy classes.

Code	Equivalent IO sector	Hazus occupancy
S1	Agriculture	AGR1
S2	Construction	IND6
S3	Other heavy industry	IND1
S4	Other light industry	IND2
S5	Food, drugs & chemicals	IND3
S6	Mining & metals/minerals processing & manufacturing	IND4
S7	High technology	IND5
S8	Wholesale trade	COM2
S9	Retail trade	COM1
S10	Banks & financial institutions	COM5
S11	Professional & technical services	COM4
S12	Education services	EDU1, EDU2
S13	Health services	COM6, COM7, RES6
S14	Entertainment & recreation	COM8, COM9
S15	Hotels	RES4
S16	Residential housing, other than hotels	RES1, RES2, RES3
S17	Other services	COM3, COM10
S18	Government & non-NAICS	GOV1, GOV2, REL1

After the direct effects of a disaster have been extracted from Hazus via the building occupancy class direct BI loss estimates, the indirect BI losses will be computed using the dynamic IO model. Recall that the dynamic IO formulation takes the form:  $q(t + 1) = q(t) + K[A^*q(t) + c^*(t) - q(t)]$ .

It is important to note that not all perils investigated in the Interim Study utilized the Hazus software. For such cases, the direct BI losses were estimated from other data sources (see Appendix K.8 for details), and compared with sector-specific value-added data published by BEA. For example, the supply-use tables (Bureau of Economic Analysis 2016) contain information on the applicable components of the value added (e.g., income and wage), which could be used to determine the magnitude of the direct BI loss relative to the output of each building occupancy class.

The Interim Study investigates the extent to which the term K in the dynamic IO formulation can be related to the concept of economic resilience. In particular, the aim of the BI loss analysis is to integrate two general types of inoperability. In the original dynamic inoperability IO model (DIIM), one assesses the inoperability of the sectors assuming that they are allowed to recover with no new additional

## NATURAL HAZARD MITIGATION SAVES:

perturbations. For tractability, a subscript 'DIIM' is introduced to the left-hand side of the equation to generate the following revised formulation:  $q_{DIIM}(t + 1) = q(t) + K[A^*q(t) + c^*(t) - q(t)]$ .

The subscript 'NEW' will be introduced to the left-hand side of the dynamic equation to represent a new level of perturbation (e.g., a resilience tactic can reduce the impact of a disaster on a sector's inoperability). One can rewrite this new dynamic equation as follows:  $q_{NEW}(t + 1) = q(t) + K[A^*q(t) + c^*(t) - q(t)]$ . It can be shown that the expected value of the inoperability at  $t + 1$  can be formulated directly from the event tree as depicted in the figure on the right, which is a simplified representation of the event tree inoperability model. Sample representations of the sequential inoperability event trees for hypothetical baseline and mitigated scenarios are shown below.

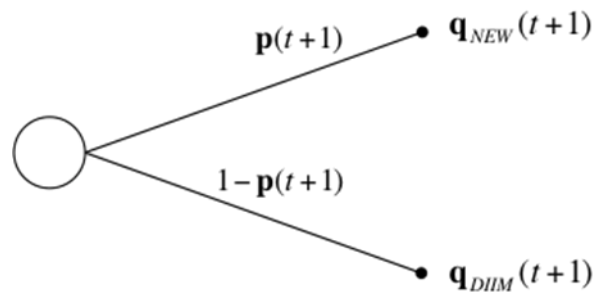

Figure 4-24: Event tree for inoperability decomposition.

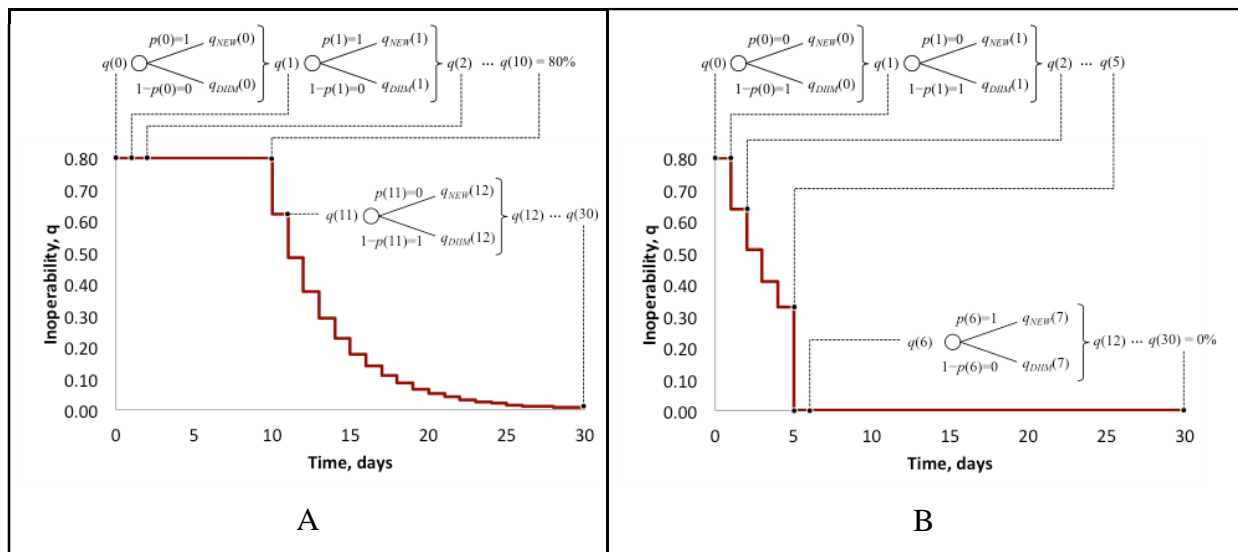

Figure 4-25: Inoperability event trees: A) sample baseline scenario, B) mitigated scenario.

At time  $t = 0$ , the sector inoperability  $q(0)$  will be directly linked to direct BI loss for each building occupancy class from Hazus. The dynamic equation then computes for the progression of indirect BI losses over time due to sector interdependencies. The Interim Study investigates the extent to which

## NATURAL HAZARD MITIGATION SAVES:

various resilience strategies can potentially decrease the magnitude of economic losses in each sector over time. For example, Rose (2009) has introduced the term static economic resilience as “the efficient use of remaining resources at a given point in time.” Furthermore, Rose defines dynamic economic resilience as “accelerating the pace of recovery.” In the Interim Study, the focus is on the following types of static economic resilience tactics: 1) production recapture; 2) inventories; 3) facility relocation; and 4) excess capacity. In subsequent discussions, the process for integrating the resilience tactics with the IO model is explained.

Within the IO framework, there are various types of economic multipliers that can provide insights in measuring the extent to which a change in an economic activity (e.g., consumption or production) of a sector can cascade to other dependent sectors. For example, the output multipliers published by BEA measure the expected changes in the output of various sectors given a \$1 change in the demand for a particular sector. Nonetheless, such multipliers often do not take into consideration the resilience attributes of the economic sectors. As a hypothetical example, suppose that the output multiplier for sector  $i$  is 2.30 for every unit change in the demand for sector  $j$ . This implies that if the demand for sector  $j$  were to grow by an amount of \$1, the *indirect* output in sector  $j$  would grow by an additional \$1.30. Note that this logic does not symmetrically apply for the case of demand reduction because the economic sectors have their static resilience attributes, hence avoiding the scenario of incurring the maximum possible loss.

Since IO multipliers are typically computed using annual data, the maximum possible loss is assumed to be distributed across a period of 1 year (although this baseline annual recovery horizon may be adjusted for disasters that require longer recovery). Without resilience, the loss is assumed to be at its greatest immediately after a disaster and exponentially dissipates over time, which as implied by the dynamic IO formulation, takes the form:  $q(t + 1) = q(t) + K[A^*q(t) + c^*(t) - q(t)]$ .

In modeling the indirect BI loss using the IO framework, the approach is to assess the extent to which each static resilience tactic can avoid operating at the maximum possible loss. The four resilience tactics specifically considered in the Interim Study and their descriptions, directly adapted from Rose (2009), are summarized as follows:

- **Production recapture:** refers to working overtime or extra shifts to recoup lost production
- **Inventory:** include both emergency stockpiles and ordinary working supplies of production inputs
- **Relocation:** changing the site of a business activity
- **Excess capacity:** refers to using idle plant and equipment

The key steps in performing the indirect BI loss methodology are enumerated below.

**Step 1.** Obtain the direct BI loss estimates for each Hazus building occupancy class, and compute the corresponding direct losses to the IO sectors using the relationship mapping given in Table 4-31. To generalize the process, a \$1 direct BI loss to each occupancy class can be arbitrarily assumed to determine the corresponding direct BI loss to the applicable IO sectors.

## NATURAL HAZARD MITIGATION SAVES:

**Step 2.** Using standard IO multiplier analysis, estimate the maximum possible indirect BI losses that can be experienced by the dependent economic sectors given the direct BI loss obtained from Step 1. Then, allocate (or spread) the maximum possible loss over a recovery period of 1 year. As noted earlier, the assumed annual recovery period can be adjusted depending on the severity of the disaster.

**Step 3.** Compute the avoided losses for each of the resilience tactics across the recovery period, relative to the maximum possible indirect BI losses obtained from Step 2. The difference between maximum and avoided losses will be considered as the indirect BI loss multiplier for each sector. The supporting data and assumptions on the efficacy of each resilience tactic in curbing the losses are shown in Table 4-32.

**Step 4.** Using the building-sector relationship mapping, trace back the corresponding indirect BI loss multiplier for each Hazus occupancy class.

There are 33 building occupancy classes in Hazus. Figure 4-26 shows the indirect BI loss generated for every \$1worth of direct loss to each occupancy class, taking into account the avoided losses due to the four resilience tactics. It can be observed that the building occupancy classes have varying levels of resilience. For example, approximately 40 cents worth of indirect BI loss is generated for every \$1worth of direct loss to the residential buildings. Metals processing, professional services, and banks appear to be highly resilient since they generate low indirect BI losses. In contrast, the entertainment sectors (e.g., movie theaters) appear to be relatively less resilient since they generate high indirect BI losses. Similar analysis can be performed for the remaining building occupancy classes. The values of the indirect BI loss multipliers for each building occupancy class are found in Section 4.13 and also Appendix K of the Interim Study.

**Table 4-32:** Data sources and assumptions for the four resilience tactics.

Tactic	Data sources	Assumptions
Production Recapture	Chapter 15 of the Hazus manual (Federal Emergency Management Agency 2012) shows the recapture rates for various occupancy classes. In particular, the project team used the output recapture factors found in the last column of Table 15.14 in the Hazus manual.	It was assumed that production recapture is highest during the first 90 days, and then decays by a factor of 25% in subsequent quarters as increasingly more customers cancel their orders and seek alternative suppliers. It was also assumed that production recapture reaches a value of 0 at the end of year 1 (e.g., production loss will not be recaptured at end of year 1 and thereafter).
Inventories	The U.S. Census Bureau publishes inventory-to-sales ratios (ISR) for various economic sectors. The following link gives up-to-date ISR data for various manufacturing and trade sectors. <sup>21</sup>	Typically, ISR values are greater than 1. The ideal case is when $ISR = 1$ , in which 100% of the production is sold within a given period. In contrast to just-in-time concepts, inventories may have an advantage in times of disasters. They can be used as buffers when production is disrupted in the aftermath of a disaster. The efficacy of inventories depend on the magnitude of the ISR and also the rate with which they get depleted as the disaster progresses over time.
Relocation	The possibility of relocating a particular building occupancy class can be implicitly derived from relevant data found in the Hazus manual. In particular, Table 15.10 of the Hazus Technical Manual gives the building recovery times for various damage scenarios.	The building recovery times are provided for different structural damage scenarios (none, slight, moderate, extensive, and complete). Each building occupancy class has data on recovery time (in days). The tipping point on whether to relocate or not is based on the moderate damage scenario. Hence, losses associated with exceeding the recovery times for the moderate scenario are assumed to be avoidable via relocation.
Excess Capacity	Excess capacity is based on Table 15.11 of the Hazus Technical Manual, which gives the building service interruption multipliers.	The building service interruption multipliers are also given for each building occupancy class for various structural damage scenarios (none, slight, moderate, extensive, and complete). It is assumed that service interruption multipliers that are relatively lower are associated with buildings that have higher excess capacity.

<sup>21</sup> See <https://www.census.gov/mtis/index.html> for more information.

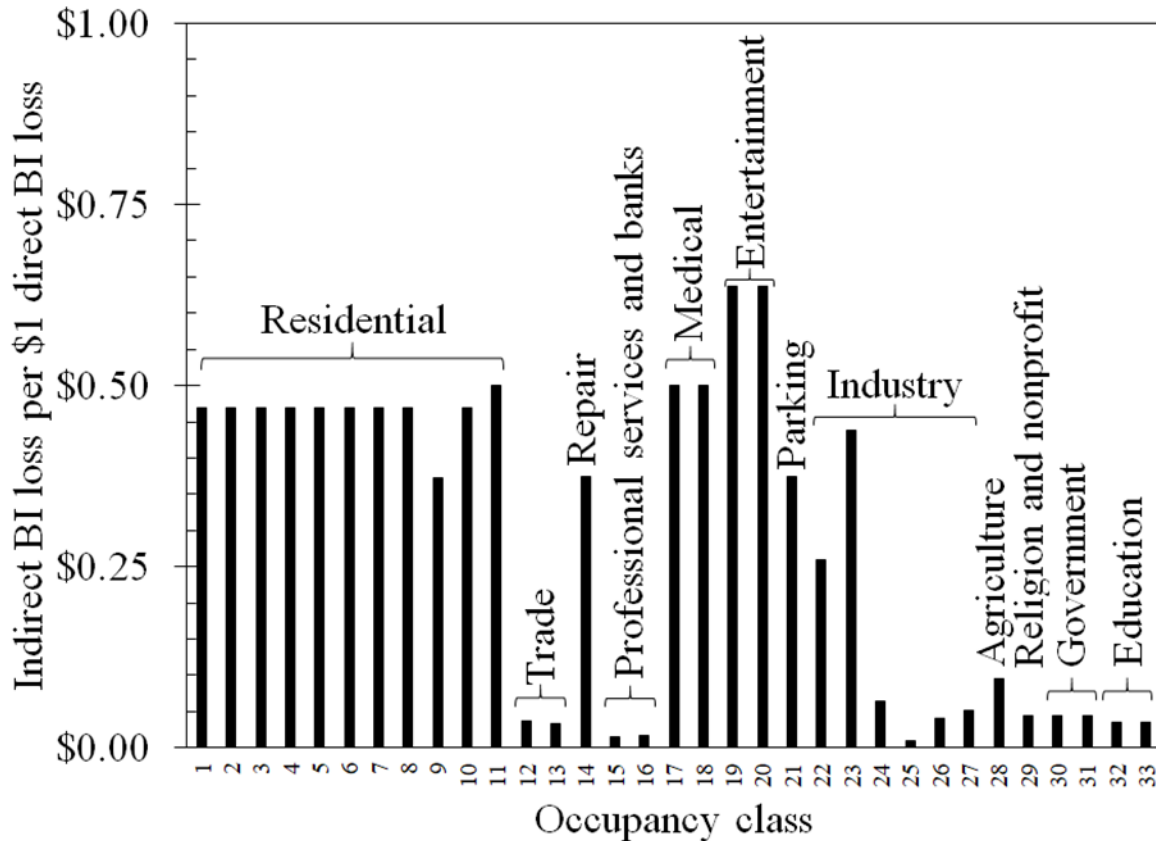

Figure 4-26: Indirect BI loss for every \$1 of direct BI loss in each Hazus building occupancy class.

#### 4.16.8. Additional Considerations in Estimating Business Interruption Losses

Disasters can cause severe damage to existing infrastructure, consequently affecting economic productivity. Temporary closure of factories and stores, loss of mobility (e.g., due to flooding and debris cleanup), and damage to infrastructure systems, among others, can drastically affect workforce and commodity flows for prolonged periods of time. Reduction in worker flow decreases productivity, and reduction in commodity flow results in cascading demand and supply impacts. Using detailed journey-to-work data, commodity flow surveys, and social accounting matrices allows modeling of disruptions to regional productivity. Modeling efforts include the potential for cascading failure, accounting for spatial dependencies and various economic and social travel patterns.

In the aftermath of a disaster, a region expects substantial disruptions to infrastructure capacity, workforce availability, and mobility. These direct disruptions in turn can trigger sector productivity degradations indirectly to all sectors of the economy. The project team collected and assembled economic data (such as input requirements, commodity outputs, and income statistics, among others) from different sources in order to quantify the impact of reduced sector productivity levels on the economy of the affected region. These data are key to calibrating the models used in the Interim Study and to simulating potential direct

and indirect BI losses from various perils with and without mitigation. The BI losses prevented are potentially a major source of benefits of mitigation.

### 4.17. ESTIMATING TOTAL (DIRECT AND INDIRECT) BUSINESS INTERRUPTION LOSS

In some cases, the project team used Hazus and FEMA's BCA Tool to estimate BI losses. The Hazus flood module (release 3.2) was found to have a bug that underestimates direct BI loss by a factor of 100, so where that tool is used (in the analysis of the cost effectiveness of federally funded grants), one can compensate for the bug by multiplying direct BI losses by 100. In the case of designing to exceed the 2015 I-Code requirements for earthquake, wind, and flood, Hazus and the BCA Tool do not apply, so the project team used the following procedures.

Rental and BI costs vary widely. Hazus offers some very old (1994) rental and disruption costs and warns that costs vary widely geographically; Therefore, it is important to revisit these amounts. For residential occupancies RES1 through RES3 and RES5, it is assumed that monthly household furniture, higher commute costs, and miscellaneous other costs of \$600/month/household, monthly house rental cost of \$1500/month/household, and 2.5 people per household (Organisation for Economic Co-operation and Development 2016), suggesting \$28/person/day or \$70/household/day. For temporary lodging (RES4), assume lost revenue and wages equal to a typical average per-night hotel cost of \$125 per day. For nursing homes (RES6), assume lost revenue and wages equal to the average daily cost of a private room in a nursing home, \$248 per day (Mullin 2013). For nonresidential occupancies, the project team estimated output loss (direct BI loss) per day of downtime as the ratio of industry wages and earnings to number of employees, converted to dollars per day. Results are shown Table 4-33.

For indirect BI, one can use IO analysis to estimate the per-dollar indirect BI loss  $Q$  resulting from \$1.00 of direct BI in a given occupancy class. See Section 4.16 for details. One can calculate  $Q$  for each occupancy class by setting the output loss for that occupancy class to \$1.00 and the output losses for all the other occupancy classes to 0. For example, to calculate  $Q$  for RES3 occupancy, set the output losses for RES1, RES2, RES4, and EDU2 to 0, and the output loss for RES3 to 1.0. The resulting indirect BI to the entire economy can then be assigned to  $Q$  for RES3. Thus, given the time  $t$  required to restore a facility to functionality, the total BI loss per occupant  $L_{BI}$  (direct and indirect) can be calculated as shown in Equation 4-36.

$$L_{BI} = V_{BI} \cdot (1 + Q) \cdot t$$

Equation 4-36

**Table 4-33:** Output loss per day of downtime VBI and per-dollar indirect BI loss Q.

No.	Occupancy Class	Label	V <sub>BI</sub>	Q
1	Single-family dwelling	RES1	\$ 28.00	0.470
2	Mobile home	RES2	\$ 28.00	0.470
3	Multi-family dwelling	RES3a	\$ 28.00	0.470
4	Multi-family dwelling	RES3b	\$ 28.00	0.470
5	Multi-family dwelling	RES3c	\$ 28.00	0.470
6	Multi-family dwelling	RES3d	\$ 28.00	0.470
7	Multi-family dwelling	RES3e	\$ 28.00	0.470
8	Multi-family dwelling	RES3f	\$ 28.00	0.470
9	Temporary lodging	RES4	\$125.00	0.372
10	Institutional dormitory	RES5	\$ 28.00	0.470
11	Nursing home	RES6	\$248.00	0.500
12	Retail trade	COM1	\$132.28	0.037
13	Wholesale trade	COM2	\$295.21	0.033
14	Personal and repair services	COM3	\$166.77	0.374
15	Professional/technical services	COM4	\$414.93	0.016
16	Banks/financial institutions	COM5	\$411.00	0.017
17	Hospital	COM6	\$243.60	0.500
18	Medical office/clinic	COM7	\$237.82	0.500
19	Entertainment & recreation	COM8	\$118.94	0.637
20	Theaters	COM9	\$118.94	0.637
21	Parking	COM10	\$118.94	0.374
22	Heavy industry	IND1	\$312.49	0.260
23	Light industry	IND2	\$242.04	0.438
24	Food, drugs, chemicals	IND3	\$203.04	0.064
25	Metals and minerals processing	IND4	\$233.26	0.009
26	High technology	IND5	\$465.98	0.041
27	Construction	IND6	\$228.35	0.051
28	Agriculture	AGR1	\$124.43	0.095
29	Church	REL1	\$165.50	0.045
30	General services	GOV1	\$230.28	0.045
31	Emergency response	GOV2	\$230.28	0.045



No.	Occupancy Class	Label	V <sub>BI</sub>	Q
32	Schools	EDU1	\$162.11	0.035
33	Colleges and universities	EDU2	\$162.11	0.035

### 4.18. INSURANCE BENEFITS

Property damage and time-element losses may be covered by insurance, especially in the case of fire damage, less so for wind and flood damage, and even less for earthquake insurance. Natural hazard mitigation can be expected to reduce natural hazard insurance losses, and in many cases the insurer reduces premiums to account for the lower risk. The property owner or other insured benefits from lower risk because his or her premiums are reduced. However, in the presence of insurance, the property owner or other insured also recovers part of the premium paid in the form of insurance claims. Thus, the benefit to the insured is just part of the reduced amount of the insurance premium: the part that the insured pays in excess of the expected value of claims, loosely termed overhead for a nonprofit insurer or O&P for a for-profit insurer. A portion of the excess amount is roughly proportional to the expected value of claims. That portion drops as the expected value of claims drops. The reduction can be counted as a benefit.

One can therefore estimate the benefit of reduced O&P using Equation 4-37 and Equation 4-38 .

$$y = \frac{P - C}{C}$$

Equation 4-37

$$B = y \cdot (EAL - EAL')$$

Equation 4-38

Where,

*B* = annual dollar benefit of reduced insurance premiums to a particular insured

*P* = premiums and other costs paid by insureds, excluding fixed costs

*C* = expected value of annual claims paid to or on behalf of all insureds

*EAL* = as-is expected annualized loss to the particular insured undertaking mitigation

*EAL'* = what-if expected annualized loss to the particular insured undertaking mitigation

*y* = fraction of *P* in excess of *C*, e.g., the average variable portion of premiums contributing to insurer's O&P costs

In the case of the NFIP, FEMA provides times series for *P* and *C*.<sup>22</sup> The time series for *P* exclude certain costs to the insureds: federal policy fees, reserve fund assessments, Homeowner Flood Insurance

<sup>22</sup> To learn more, visit: <https://www.fema.gov/statistics-calendar-year>.

## NATURAL HAZARD MITIGATION SAVES:

Affordability Act (HFIAA) surcharges, and probation surcharges. Of these, the reserve fund assessment scales with risk. In 2016, the reserve fund assessment totaled \$0.495 billion, which amounts to 15% of \$3.370 billion in net written premium (T. Hayes, FEMA Chief Actuary, written communication, 11 Apr 2017). Therefore 15% is added to each value of net written premium in the time series to estimate  $P$ . Figure 4-27 plots accumulated values  $y$  from 1978 to present day. The final value of  $y$ , averaging over all 38 years of  $y$  data, is 0.17, a relatively low amount compared with commercial insurers, because the NFIP does not have to produce a profit and because it incurs no reinsurance costs, the reinsurer effectively being the U.S. Treasury. Bear in mind that the 0.17 figure excludes fees, assessments, and surcharges that do not scale with risk. See Box 4-3 for a restatement of insurance benefit.

### Box 4-3. Clarifying Insurance Benefits

Insurance savings are only attributable to the reduction in the portion of insurance premiums associated with administrative costs. Consider: if one builds an insured house to a higher standard, building repair costs go down, but that savings can only be counted once. If the property is insured, the insurer pays the repair costs, but those costs are completely offset in the long run by a portion of the premiums that the property owner has paid. (That portion is called *pure premium*.) Otherwise, the property owner pays the repair costs. One way or another, the property owner pays for the repairs, either through pure premium, which passes through the insurer, or directly to contractors. But the property owner also pays for the insurer's administrative costs (in the case of NFIP), or O&P (in the case of private insurance). In the case of NFIP, the administrative costs amount to a factor of about 0.17 times the pure premium. Private insurance has a higher ratio of O&P to pure premium, about 0.42. That is, the property owner pays total NFIP premiums and fees of about 1.17 times the pure premium, or about 1.17 times what the property owner could expect to pay, on average, over the long term, to repair damage, or 1.42 for private insurance.

Assume that in the long run, on an overall average, insurance is priced so that the average insured pays the same factor for administrative cost, regardless of whether the property is built to code or above code. That is, assume insurance is priced properly, in proportion to pure premium. The reduction in administrative costs or O&P scales with the reduction in building repair costs. Reduce repair costs by \$100 and one reduces NFIP administrative costs by \$17 or private insurance O&P by \$42. Therefore, one can estimate the insurance benefit as a factor of property loss reduction.

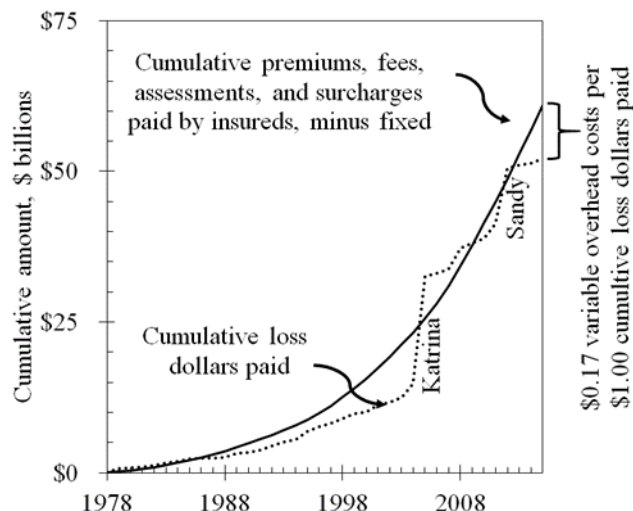

Figure 4-27: Overhead factor  $y$  for NFIP flood insurance.

Here are the implications of Equation 4-38: One expects  $B$  to fluctuate over short periods of time but to stabilize over the long run. One expects the policyholder's benefit to be highest in years when NFIP is profitable, e.g., when there are no big catastrophes, because NFIP's revenues in excess of losses come out of the policyholder's premiums and other fees, assessments, and surcharges. The space between the dotted and solid lines in Figure 4-27 is  $y$ , which is proportional to benefit. It is largest in years without a big catastrophe, as one would expect. One expects the policyholder's benefit to drop in years when a big catastrophe occurs, because NFIP's revenues in excess of losses are lower or negative in that year. That may seem counterintuitive, but remember that less NFIP excess revenue means less savings to the policyholder, again because NFIP excess revenue comes out of the policyholder's pocket. That is what Figure 4-27 shows: smaller or negative values of  $y$  appear around Hurricanes Katrina (2005) and Sandy (2012).

## 4.19. DEATHS, NONFATAL INJURIES, AND POST-TRAUMATIC STRESS DISORDER

### 4.19.1. Deaths and Nonfatal Injuries

The *2005 Mitigation Saves* study considered many ways to assign an economic value to human health. (See that work for several options and their advantages and disadvantages.) As in 2005, the 2017 project team valued human health as the DOT's acceptable cost to avoid a statistical injury.<sup>23</sup> By that approach, a 2015 regulation that prevents injuries would be deemed cost effective if it cost less than \$9.4 million per statistical fatality avoided, and lesser amounts for lesser injuries, in the proportions shown in Table 4-34. Table 4-35 expresses the acceptable costs to avoid statistical injuries, in terms of Hazus injury severity

<sup>23</sup> To learn more, visit: [https://www.transportation.gov/sites/dot.gov/files/docs/VSL2015\\_0.pdf](https://www.transportation.gov/sites/dot.gov/files/docs/VSL2015_0.pdf).

levels. The 2017 project team mapped from AIS to Hazus injury levels the same way as in the 2005 *Mitigation Saves* study. Note that a statistical fatality refers to the death of an unknown person at some unknown time in the future, not the death of a particular person in peril at the present time or the death of a particular person in the past.

**Table 4-34:** Acceptable cost to avoid a statistical injury, with injuries measured by AIS.

AIS level <sup>(a)</sup>	Severity	Fraction of VSFA <sup>(b)</sup>
AIS 1	Minor	0.0020
AIS 2	Moderate	0.0155
AIS 3	Serious	0.0575
AIS 4	Severe	0.1875
AIS 5	Critical	0.7625
AIS 6	Fatal	1.0000

(a) AIS refers to the abbreviated injury scale used by the Association for the Advancement of Automotive Medicine (2001) and (b) VSFA refers to the acceptable cost to avoid a statistical fatality (\$9.5 million in the third quarter of 2016, using the GDP implicit price deflator from Federal Reserve Bank of St. Louis).

**Table 4-35:** Acceptable cost to avoid a statistical injury, with injuries measured by Hazus injury severity.

Severity	Fraction of VSFA	Cost (2016 \$)	Comment
Hazus 1	0.0056	53,000	Geometric mean of AIS 1 and 2
Hazus 2	0.0575	550,000	Same as AIS 3
Hazus 3	0.3781	3,700,000	Geometric mean of AIS 4 and 5
Hazus 4	1.0000	9,500,000	Same as AIS 6

To apply these values in calculating EAL, the acceptable cost to avoid a statistical injury is calculated using Equation 4-39, in which  $N$  denotes the mean number of people in the asset at an arbitrary time of day,  $j$  is an index to injury severity,  $V_j$  denotes the acceptable cost to avoid a statistical injury of severity  $j$ , and  $y_j(x)$  denotes the mean fraction of occupants who experience injury severity  $j$  when the asset experiences excitation  $x$ .

$$L(x) = N \cdot \sum_j V_j \cdot y_j(x)$$

Equation 4-39

### 4.19.2. Post-Traumatic Stress Disorder (PTSD)

Considering the time frame of this project, the best approach to include costs and benefits related to reducing PTSD is a simplified method based on Sutley et al. (2016a). Based on this work and others on

PTSD after disasters, the project team used AIS level 3 or Hazus injury severity 2 as a proxy for rates of PTSD in a community. That is, one takes the number of people who are estimated to experience PTSD as equal to the number who are estimated to experience Hazus injury severity 3. (See Table 4-32 for the relationship between AIS and Hazus injury severity.)

The likelihood of a person experiencing PTSD is clearly impacted by the person's socioeconomic status but, for practical reasons, this analysis does not adjust for socioeconomic status. As reflected in the work by Sutley et al. (2016a), rates of PTSD are higher among children, the elderly, racial and ethnic minorities, single parents, women, and the poor. By not modifying the proxy measure of PTSD by these factors, this method takes a conservative approach to including these costs and benefits.

The project team considered the cost of mental health impacts similarly to costs related to injuries as a whole, that is, as an acceptable cost to avoid a future statistical injury, as opposed to the expense associated with a particular injury. The costs consider direct treatment costs where treatment is about 10% of the overall costs of the incidence, and the other costs include things like lost wages, lost household productivity, and pain and suffering. In 2008, as the result of a two-year study, RAND estimated the cost to treat PTSD in military personnel to be between \$5,900 and \$10,300. With co-morbidities such as depression, the cost can be significantly higher (\$16,890) (Tanielian and Jaycox 2008). These costs would be higher still if the length of their study were longer, as those authors note. The Interim Study uses \$9,000 for direct treatment costs and \$90,000 for the overall acceptable cost to avoid a statistical incidence of PTSD. As reported in the *2005 Mitigation Saves* study, 10% of the costs of an injury are considered direct medical costs, with the remaining value other costs as highlighted above. The \$90,000 is consistent with this documented approach.

Because few BCAs even attempt to include these costs, the addition of acceptable costs to avoid a statistical instance of PTSD is a conservative but innovative addition to the 2017 *Mitigation Saves* study. The acceptable cost to avoid incidents of PTSD is estimated using Equation 4-39, where  $N$  denotes the number of people estimated to experience PTSD and  $V_{PTSD}$ , the acceptable cost to avoid a single incident, is taken as \$90,000.

### 4.19.3. Discounting Human Life, Nonfatal Injuries, and PTSD

As in the *2005 Mitigation Saves* study, the Interim Study does not apply the time value of money to discount human deaths, nonfatal injuries, and PTSD. Instead, it values an injury avoided some years hence equal to an injury avoided 1 year hence, and recognizes avoided injuries over the useful life of a mitigation project or a building. The rationale, briefly, is that 1) there are actual financial instruments and measures of the time value of money, but no equivalent indices for human life, and 2) a reduction ad absurdum argument: if one applies a monetary discount rate to human life—any positive discount rate—one must accept that there is a duration of time where the cost of a cup of coffee today is somehow greater in value than a million human lives in the future. Since the conclusion appears morally untenable, one can reject the premise. Standard practices differ from agency to agency. For example, the value of a statistical fatality

avoided (VSFA) differs between sources. Since this is an independent Interim Study, the project team applied its own judgment of what constitutes best practice, including whether and how to apply a discount rate to human safety.

### 4.20. OTHER INTANGIBLES

Other intangibles addressed in the 2005 study tended to contribute a relatively small amount to the benefits. (For additional details on this approach, consult Appendix J of the 2005 report.) The loss of intangibles such as historical buildings and environmental damage are valued with benefit-estimate-transfer approaches. These vary by the type of benefit to be recognized: recreational water quality; drinking water; outdoor recreation trips; hazardous waste; wetlands; aesthetics; health and safety benefits from underground power lines; and cultural and historical resources.

Disaster researchers have not yet produced a systematic method to quantify all losses that occur in a disaster. Some of these are illustrated in Figure 4-28. Disasters disconnect people from friends, schools, work and familiar places. They ruin family photos and heirlooms and alter relationships. Large disasters may cause permanent harm to culture and one's way of life, and impact the most socially and financially marginal people. Disasters may have long-term consequences for health and collective wellbeing. These events also often hurt and kill pets and destroy natural ecosystems that are integral parts of communities. Disasters clearly disrupt life's arc in ways that are hard to express, let alone assign monetary worth. Even the potential for future disasters affects people's peace of mind. Mitigation saves more than is estimated in this report.



Figure 4-28: Some intangibles that are not quantified here: A) Continuity of life's arc. B) Heirlooms. C) Culture. D) Disproportionate impacts on vulnerable populations. E) Pets. F) Ecosystems. [Image credits: A, B, E and F: Public domain. C: Elisa Rolle, CC-BY-SA3.0. D: Matty1378, CC-BY-SA3.0.]

## 4.21. ESTIMATING EXPECTED ANNUALIZED LOSSES

The expected annualized loss (*EAL*) from any given loss category (property loss, BI, etc.) is calculated as shown in Equation 4-40. In the equation,  $G(x)$  denotes the mean annual rate of exceeding excitation  $x$ .

$$EAL = \int_{x=0}^{\infty} L(x) \left| \frac{dG(x)}{dx} \right| dx$$

Equation 4-40

For earthquake risk,  $L(x)$  is taken as piecewise linear with  $x$  and  $\ln(G(x))$  as piecewise linear with  $x$ , in which case one can perform the integration exactly, as shown in Appendix K.18, Equation A-64. For other perils, one can evaluate Equation 4-40 numerically, generally as shown in Equation 4-41. One generally knows the excitation  $x$  and its mean recurrence interval  $MRI$  at  $N$  increments. For example, the project team estimated the coastal wind hazard at  $N = 6$  mean recurrence intervals of 10, 50, 100, 300, 700, and 1,700 years. In the equation,  $G = 1/MRI$ .

$$EAL \approx \left( \sum_{i=0}^{N-2} L(x_i) \times (G_i - G_{i+1}) \right) + L(x_{N-1}) \times G_{N-1}$$

Equation 4-41

## 4.22. ESTIMATING AND AGGREGATING BENEFITS AND COSTS TO THE NATIONAL LEVEL

### 4.22.1. Aggregating Above-Code Design Results by Peril to the National Level

**Common approach.** For each peril and location, the project team estimated an IEMax design level as discussed in Section 4.7. In cases where designing to exceed I-Code requirements is not cost effective, the project team took the IEMax level as current design practice. In all cases, “current design practice” means complying with the requirements of the 2015 I-Codes (IBC or IRC, as appropriate). In the case of fire at the WUI, “current design practice” means no requirement to comply with the 2015 IWUIC, except insofar as the IBC makes the same requirements. For each peril, nationwide BCR is calculated as follows:

$$B_{A,p} = \sum_o I_o \left( \sum_m \left( \Delta EAL_{m,res,o} \times \frac{(1 - e^{-r_{res} \times t})}{r_{res}} + \Delta EAL_{m,nres,o} \times \frac{(1 - e^{-r_{nres} \times t})}{r_{nres}} \right) + \sum_i \Delta EAL_{i,o} \times t \right)$$

Equation 4-42

$$C_{A,p} = \sum_o I_o \times C_o$$

Equation 4-43



$$BCR_{A,p} = \frac{B_{A,p}}{C_{A,p}}$$

Equation 4-44

Where,

$B_{A,p}$  = nationwide benefit of designing above (A) I-Code requirements for a given peril  $p$  (flood, wind, earthquake, or fire)

$BCR_{A,p}$  = nationwide BCR of designing above (A) I-Code requirements for a given peril  $p$

$C_{A,p}$  = nationwide cost of designing above (A) I-Code requirements for a given peril  $p$

$C_o$  = additional cost to design and build all properties in location  $o$  to the IEMax level exceeding I-Code requirements in that location (the subscripts  $A$  and  $p$  are omitted for brevity)

$\Delta EAL_{m,res,o}$  = reduction in expected annualized loss for monetary benefit category  $m$ , all residential properties in location  $o$ , assuming all such properties are designed to the IEMax level of design to exceed I-Code requirements

$\Delta EAL_{m,nres,o}$  = reduction in expected annualized loss for monetary benefit category  $m$ , all nonresidential properties in location  $o$ , assuming all such properties are designed to the IEMax level of design to exceed I-Code requirements

$\Delta EAL_{i,o}$  = reduction in expected annualized loss associated with casualties and PTSD of category  $i$  in location  $o$ , assuming all properties are designed to the IEMax level of design to exceed I-Code requirements

$i$  = index to categories of human injuries and PTSD (e.g., Hazus injury severities 1, 2, 3, and 4, and PTSD)

$I_o$  = an indicator function: 1 if designing to exceed I-Code requirements is cost effective at location  $o$ , 0 otherwise

$m$  = an index to monetary benefit categories: building and content repair costs, direct and indirect BI costs, environmental benefits, preservation of historical value

$o$  = index to locations, e.g., counties for earthquake, wind speed bands for wind, etc.

$p$  = peril: flood, wind, earthquake, or fire

$r_{res}$  = discount rate for residential properties; see Appendix H for value

$r_{nres}$  = discount rate for nonresidential properties; see Appendix H for value

## NATURAL HAZARD MITIGATION SAVES:

$t$  = duration over which the benefits are to be recognized; the present Interim Study uses  $t = 75$  years; see Appendix I for rationale.

**Earthquake.** In the case of earthquake, locations are indexed by county. The IEMax design level is the highest value of  $I_e$  where the ratio of incremental benefit to incremental cost exceeds 1.0 in that county, as in Section 4.7. In cases where designing to exceed I-Code requirements is not cost effective, the IEMax level is  $I_e = 1.0$ , that is, code-level design.

**Wind.** In the case of hurricane wind, locations are indexed by ASCE 7-16 wind bands, and by a distance to coast band of 1 mile to delineate IBHS FORTIFIED Home Hurricane requirements. The IEMax design level is the corresponding IBHS FORTIFIED Home program where the ratio of incremental benefit to incremental cost exceeds 1.0, as in Section 4.7. In cases where designing to exceed I-Code requirements is not cost effective, the IEMax level is baseline IRC requirements, that is, code-level design.

**Coastal surge.** In the case of coastal surge, locations are indexed by ASCE 7-16 wind bands and by state. The IEMax design level is the corresponding incremental building elevation where the ratio of incremental benefit to incremental cost exceeds 1.0, as in Section 4.7.

**Riverine and coastal flood.** The IEMax level is measured at a small geographic level with the highest value of floor elevation above BFE where the ratio of incremental benefit to incremental cost exceeds 1.0, as in Section 4.7. In cases where building above BFE + 1 foot is not cost effective, the IEMax level is BFE + 1 foot, that is, code-level design.

**Fire.** For fire at the WUI, that IEMax level is measured at a smaller geographic level with the binary variable: is it cost effective to adopt the 2015 IWUIC, yes or no?

### 4.22.2. Aggregating Federal Grant Results by Peril to the National Level

**Common Approach.** For each peril, hazard stratum, and sample project, the project team calculated the reduced EAL by benefit category (generally building damage, content damage, direct BI, indirect BI, casualties, PTSD, environmental value, historical value). The project team estimated the project benefit  $b_o$  using Equation 4-45 and the project-level BCR using Equation 4-46.

$$b_o = \left( \sum_m \left( \Delta EAL_m \times \frac{(1 - e^{-r \times t})}{r} \right) + \sum_i \Delta EAL_i \times t \right)$$

Equation 4-45

$$bcr_o = \frac{b_o}{c_o}$$

Equation 4-46

Where,

## NATURAL HAZARD MITIGATION SAVES:

$b_o$  = benefit of mitigation investment for project  $o$

$c_o$  = mitigation cost of project  $o$

$bcr_o$  = BCR for project  $o$

Two indices  $h$  and  $p$  to  $bcr_o$  indicate the hazard level  $h$  (low, medium, or high) and the peril  $p$  that the grant mitigates. One can aggregate benefits from all U.S. government-funded mitigation grants for the given peril to the national level using Equation 4-47, the nationwide total cost of all projects for the given peril using Equation 4-48, and the overall nationwide BCR for the given peril using Equation 4-49.

$$B_{G,p} \approx \sum_h \left( C_{6A,h,p} \times \left( \frac{1}{n_{6,h,p}} \sum_{o_{h,p}} bcr_{o,h,p} \right) \right)$$

Equation 4-47

$$C_{G,p} = \sum_h C_{G,h,p}$$

Equation 4-48

$$BCR_{G,p} = \frac{B_{G,p}}{C_{G,p}}$$

Equation 4-49

Where,

$B_{G,p}$  = nationwide benefit of all government-funded mitigation grants (G) for the given peril  $p$ , whether sampled or not

$BCR_{G,p}$  = nationwide BCR for all government-funded mitigation grants (G) for the given peril  $p$

$bcr_{o,h,p}$  = BCR for sample  $o$  within hazard level  $h$  in the given peril  $p$  (Equation 3-36)

$C_{G,p}$  = cost of all government-funded mitigation grants (G) for the given peril  $p$

$C_{G,h,p}$  = cost of all grant-funded projects in peril  $p$ , hazard stratum  $h$ , whether sampled or not

$h$  = index to hazard levels (low, medium, high)

$n_{G,h,p}$  = number of grant-funded (G) sample projects in hazard level  $h$  for the given peril  $p$

$p$  = peril: flood, wind, earthquake, or fire

### 4.22.3. Aggregating Results Across Perils to a Nationwide Level

One can aggregate all benefits, costs, and the BCR for all designs above (A) I-Code requirements using Equation 4-50 through Equation 4-52.

$$B_A = \sum_p B_{A,p}$$

Equation 4-50

$$C_A = \sum_p C_{A,p}$$

Equation 4-51

$$BCR_A = \frac{B_A}{C_A}$$

Equation 4-52

Where,

$B_A$  = benefit of all designs above (A) I-Code requirements and compliance with 2015 IWUIC where cost effective

$C_{2A}$  = cost of all designs above (A) I-Code requirements and compliance with 2015 IWUIC where cost effective

$BCR_A$  = BCR of all designs above (A) I-Code requirements and compliance with 2015 IWUIC where cost effective

One can aggregate all benefits, costs, and the BCR for all federal mitigation grants using Equation 4-53 Equation 4-55.

$$B_G = \sum_p B_{G,p}$$

Equation 4-53

$$C_G = \sum_p C_{G,p}$$

Equation 4-54

$$BCR_G = \frac{B_G}{C_G}$$

Equation 4-55

Where,

$B_G$  = benefit of all grant (G) funded mitigation

$C_{6A}$  = cost of all grant (G) funded mitigation

$BCR_{6A}$  = BCR of all grant (G) funded mitigation

### 4.23. ALLOCATING NET BENEFITS TO STAKEHOLDER GROUPS

Different stakeholders bear different costs and enjoy different benefits of designing new buildings to exceed code provisions. Here is an estimate of how costs and benefits are distributed among five stakeholder groups:

1. **Developers:** Corporations that invest in and build new buildings, and usually sell the new buildings once they are completed, owning them only for months or a few years.
2. **Title holders:** People or corporations who own existing buildings, generally buying them from developers or from prior owners.
3. **Lenders:** People or corporations that lend title holders the money to buy the building. Loans are typically secured by the property, meaning that if the title holder defaults on loan payments, the lender can take ownership.
4. **Tenants:** People or corporations who occupy the building, whether they own it or not. This work uses the term “tenant” somewhat loosely, and includes visitors.
5. **Community:** People, corporations, local government, emergency service providers, and everyone else near the building or who does business with the tenants.

The project team attempted to allocate costs and benefits to various stakeholders. Developers initially bear any higher up-front construction costs, with such costs transferred entirely to subsequent building owners. While the developer would have to make a larger investment to build a more-expensive building, the developer would pass the cost on to the subsequent buyer, carrying the cost only during his or her ownership period. The added construction cost is assigned to later owners (the title holders), who transfer an estimated fraction of it to the tenants.

Building owners (the title holders) enjoy most of the benefits of reduced building repair costs, and tenants enjoy most of the reduction in content loss. The project team also examined the allocation of reduced building repair costs. If a natural disaster seriously damages a building, the title-holder might be unable to pay for the repairs and default on the mortgage, leaving the bank or other lender with a property where the resale value is less than the lender’s pre-disaster equity. The project team did not know what fraction

## NATURAL HAZARD MITIGATION SAVES:

of the reduction in property repair costs accrues to lenders; likely it is a relatively small amount, perhaps on the order of 10%. Therefore, 10% of building repairs were assigned to lenders. Since the developer will be the title holder for approximately 3 years out of the 75-year assumed life of the building, the project team assigned  $3/75 \times 90\%$ , or 3.6% of the benefit of reduced building repair cost to the developer, 86.4% to the title holder, and 10% to the lender. Where building and content loss are calculated under one heading of property loss, the loss is approximated as two-thirds building repairs and one-third content loss.

Note, a hidden attribute of the reduction in property losses when it comes to earthquakes. Making buildings stiffer generally increases content damage rather than decreasing it. However, the increase in content damage is generally much smaller than the decrease in other aspects of property loss.

Tenants generally enjoy the benefits of reduced ALE and direct BI. The people and corporations who buy from or sell to tenants enjoy the benefits of reduced indirect BI; these people and corporations are part of the broader community.

In the case of common property insurance, such as fire or flood insurance, the title holder enjoys any reduction in insurance O&P costs (in the case of wind or fire), or reduction in administrative costs and fees (in the case of the NFIP). Since only a small fraction of properties are insured for earthquake, earthquake insurance is ignored here.

Tenants and visitors enjoy the benefits of enhanced life safety, and, to some extent, so do casualty insurers, although emergency medical care and workers' compensation insurance account for a relatively modest fraction of the acceptable statistical cost to avoid deaths and injuries. For example, the average American has far less life insurance than the U.S. government assigns to the acceptable cost to avoid a statistical fatality (\$9.5 million). Only 44% of people have life insurance (LIMRA 2016). Life insurance coverage in the United States totals approximately \$19.2 trillion (Life Insurance Selling Magazine 2013). Divide that by the U.S. population (321 million people in 2015) to see that the average amount of life insurance per person (including the uninsured) is just under \$60,000, or about 0.6% of the \$9.5 million figure. Even if the fraction is somewhat larger for non-fatal injuries, insurers probably enjoy a relatively small fraction of the life-safety benefit, on the order of 1%.

Local communities enjoy the benefits of reduced cost of urban search and rescue. The local community here are the taxpayers who support the fire department and emergency medical services.

How can the stakeholder benefits be quantified mathematically? This is represented with a matrix equation, as in Equation 4-56:

$$S = AB$$

Equation 4-56

Where,

$A = m \times n$  benefit-transfer matrix, where  $m$  = number of stakeholder categories,  $n$  = number of cost and benefit categories, and entry  $A_{ij}$  is the fraction of cost or benefit category in column  $j$  that the stakeholder in row  $i$  bears or enjoys. Table 4-36 presents the benefit-transfer matrix derived here.

$B = n \times 1$  vector of benefit, where entry  $B_i$  denotes the cost or benefit in category  $i$ . A quantity in parentheses means the benefit is negative. “Negative benefit” means either an immediate cost (as in the case of construction cost) or a future cost (as in the case of future content repair cost, which generally increases rather than decreases when one builds new buildings to be stiffer).

$S = m \times 1$  vector of stakeholder net benefit by stakeholder group, where entry  $S_i$  is net benefit to stakeholder group  $i$

Table 4-36 contains benefit-transfer matrix  $A$ , with rows and columns labeled for clarity.

**Table 4-36:** Benefit-transfer matrix  $A$ .

	Construction Cost	Property	ALE and Direct BI	Indirect BI	Insurance	Death, Injury, PTSD
Developer		2%			4%	
Title holder	50%	58%			86%	
Lender		7%			10%	
Tenant	50%	33%	100%			99%
Community				100%		1%

The net benefit (the contents of vector  $S$ ) means the benefit each stakeholder group experiences minus the costs they bear from designing new buildings to exceed 2015 I-Code design requirements (in the case of flood, wind, or earthquake) or to comply with the 2015 IWUIC (in the case of fire at the WUI). Some critics might object to the notion of net benefit to some stakeholder groups—especially developers—because of the implication that a positive net benefit means that a stakeholder group would or should value designing to exceed I-Code requirements. Box 4-4 addresses that question.

Policymakers regularly express interest in how any given policy option would affect employment. Although the Interim Study, like the *2005 Mitigation Saves* study, excludes job creation per se from both the benefit and the cost side of the BCR, the quantity may nonetheless interest some readers. How can job creation be quantified? The study of job creation is restricted to designing to exceed I-Code requirements for flood, wind, and earthquake, and compliance with the 2015 IWUIC for fire.

### Box 4-4. Is There Really Value in Building Better?

Critics might object to the notion that owners value better buildings, based on the following observations: owners are not already constructing buildings to be stiffer or stronger; renters have not expressed a willingness to pay more for better buildings; and insurers have not recognized improved resilience in setting rates for earthquake insurance. All three statements are demonstrably false.

Would owners value better buildings? After conversations with the Building Owners and Managers Association (BOMA) of Greater Los Angeles, Lucy Jones reported (L. Jones, written communication, November 20, 2015),

“At my meeting with the board of the Building Owners and Managers Association of Greater Los Angeles, attendees said they would accept an unspecified greater construction cost to achieve better seismic performance, if it was mandated. They also said they would like to see it mandated because they don't want to have their building be a financial loss after the earthquake, and having the building cost more to build would just be the cost of business in Los Angeles much like higher labor costs in some areas. But even though they want the higher performance, they can't afford to pay that extra cost if they are the only ones - they don't believe that tenants will pay higher rents for seismic performance.”

Owners would value, and even prefer, better buildings, as long as the investment does not disadvantage them relative to competitors. Some owners have already decided to pay more for better buildings, despite not being required to do so. Just two examples: for 30 years, Cal-Tech built its new buildings 50% stronger than local code required, because it valued the better likely performance (CalTech Design and Construction 2014). A private client of Porter independently decided several years ago to design all its new dry-goods distribution centers to  $I_e = 1.25$ , exceeding the minimum strength requirement by 25% because its executives wanted better performance than the code requires. Another private client decided to build certain of its critical facilities to the same  $I_e$  factor.

What about renters' willingness to pay more for better buildings? As Davis and Porter (2016) show, a scholarly survey of 400 Californians and 400 adults from the Saint Louis, MO, and Memphis, TN, metropolitan areas shows the people generally expect and are willing to pay for better seismic performance from new buildings. The survey shows no strong effect either of household income or educational attainment.

As for insurers valuing better resilience through insurance premiums, the California Earthquake Authority (CEA) offers earthquake premium reductions for certain retrofit measures. The California State Automobile Association offered such discounts years before the formation of the CEA. Seismic vulnerability is a rating factor that affects insurance premiums, meaning that insurers support and encourage better resilience, and have done so for decades.

In any case, FEMA and the Interim Study use a broader definition of value than renters' willingness to pay. The Interim Study is concerned with value as the federal government views value, including reduced future property repair costs, future deaths and injuries, and future direct and indirect BI. Value means more than just the money that the owner saves or the tenant is willing to pay. Their value is only a portion of the value of greater resilience to society. The combination of greater strength and stiffness undeniably reduces future losses. By FEMA's own definitions, the present value of those reduced future losses is called benefit. Benefit is a value. By FEMA's definitions and procedures, building better has value.



## 4.24. JOB CREATION

Most of the marginal cost for designing to exceed I-Code requirements (at least for earthquake) comes from additional structural material: more concrete, steel, wood, and connectors. Higher open foundations for flood resistance mostly involves more material, as opposed to labor costs. Other flood measures and wind measures involve relatively more labor. However, an important focus is on jobs created by requiring more construction materials. Structural materials represent about 10% of construction cost, so an increment  $D$  in construction cost involves contractors buying about  $D/0.10$  more structural material. Thus, a  $D = 0.1\%$  increase in construction cost nationwide would involve purchasing about 10% more structural materials nationwide. It is important to relate the incremental increase in construction cost to the number of added jobs in industries that provide structural materials by supposing that the number of U.S. jobs in industries that supply structural materials scales with the quantity of domestically produced structural material.

For example, if changes in construction practice led to the United States consuming 1% more construction sand and gravel nationwide on a regular, ongoing basis, and if virtually all of U.S. consumption was satisfied by sand and gravel produced in the United States, then U.S. employment in the production of construction sand and gravel would rise by 1%, or a lesser fraction in proportion to the fraction of U.S. consumption supplied by U.S. production. If the United States employs approximately 27,000 people in the production of construction sand and gravel, and if virtually all construction sand and gravel consumed in the United States were produced domestically, then the 1% increase in demand would result in around 270 new, long-term jobs in that industry.

Some groups may contend that job creation to retrofit existing buildings (as in federal mitigation grants) would be largely short-term if it added jobs at all. The project team identified two responses: first, with new construction, consider only jobs created under above-code measures. Second, even if one were to consider a retrofit, many construction firms specialize, including firms that specialize in retrofit. A long-term increase in retrofit efforts would tend to produce new employment among retrofit contractors.

Job creation for designing to exceed I-Code requirements (for earthquake, at any rate) is estimated as follows:

**Step 1.** List North American Industry Classification System (NAICS) classifications associated with manufacture and sale of structural materials. (See Table 4-37)

**Step 2.** Get recent U.S. employment data, e.g., from Bureau of Labor Statistics  $N$  = U.S. employees in manufacture and sale of structural materials.

**Step 3.** Estimate  $f = (\text{U.S. consumption})/(\text{U.S. production}) = [(\text{Value of Product Shipments}) - (\text{Total Export Value of Goods}) - (\text{General Import Value of Goods})] / [(\text{Value of Product Shipments}) - (\text{General Import Value of Goods})]$ . (U.S. Census Bureau 2012)

## NATURAL HAZARD MITIGATION SAVES:

**Step 4.** Estimate  $g$ , increase in domestic consumption of structural materials from above-code measures. As noted above,  $g = 10 \times D$ .

**Step 5.** If estimating job creation at the state level, estimate  $h = (\text{state construction employment})/(\text{national construction employment})$ , e.g., from Bureau of Labor Statistics (2017a and 2017b).

**Step 6.** Estimate added jobs by NAICS classification,  $J \approx N \times f \times g = 10N \times f \times D$ , and sum over classifications. Using values of  $N$  and  $f$  in Table 4-37, one can estimate nationwide job creation using Equation 4-57, and at a state level, using Equation 4-58.

$$J = 8,650,000 \times D$$

Equation 4-57

$$J = 8,650,000 \times D \times h$$

Equation 4-58

**Table 4-37:** U.S. job-creation data for designing to exceed I-Code requirements for earthquake.

NAICS classification	$N$ (1,000)	$f$
Construction Sand and Gravel Mining: 212321	27.0	1.0 <sup>(c)</sup>
Sawmills: 3211	90.7	0.78
Veneer, Plywood, and Engineered Wood Product Manufacturing: 3212	78.5	0.78
Cut Stock, Resawing Lumber, and Planing: 321912	50.1	0.78
Ready-Mix Concrete Manufacturing: 327320	95.4	1.0
Concrete Block and Brick Manufacturing: 327331	32.5 <sup>(a)</sup>	0.99
Other Concrete Product Manufacturing: 327390	32.5 <sup>(a)</sup>	0.97
Iron and Steel Mills and Ferroalloy Manufacturing: 331110	83.5	0.73
Rolled Steel Shape Manufacturing: 331221	55.7	0.98
Plate Work and Fabricated Structural Products 33231	159.5	0.91
Other Fabricated Wire Product Manufacturing: 332618	34.4 <sup>(bc)</sup>	0.57
Lumber, Plywood, Millwork, & Wood Panel Merchant Whsl: 423310	105.3	1.0 <sup>(d)</sup>
Metal Service Centers and Other Metal Merchant Wholesalers: 423510	121.8	1.0 <sup>(d)</sup>

(a) One-third of employment in a sector where data for  $N$  includes 2 others

(b) Half of employment in a sector where data for  $N$  includes 1 other

(c) Bolen, W. (2001)





(d) Assumed

## 5. Project Data, Sampling, and Other Analytical Details

This chapter summarizes the data the project team acquired from federal grant programs. It also presents details of additional data acquired and of additional assumptions and procedures to deal with idiosyncrasies of project data and peril- or program-specific analysis.

### 5.1. FEDERAL MITIGATION PROGRAM DATA

FEMA provides public-assistance funding for cost-effective hazard mitigation for eligible facilities damaged by natural disasters under Stafford Act Section 406.<sup>24</sup> FEMA also provides hazard mitigation funding under its HMA programs. FEMA's Federal Insurance and Mitigation Administration (FIMA) administers the HMA programs, with expenditures authorized under Stafford Act Sections 203 and 404, and the National Flood Insurance Act of 1968.<sup>25</sup> HMA programs include the Hazard Mitigation Grant Program (HMGP), Flood Mitigation Assistance (FMA), and PDM programs, as illustrated in Figure 5-1.

Stafford Act Section <b>406</b>	Stafford Act Section <b>404</b>	National Flood Insurance Act of 1968 <b>NFIA</b>	Stafford Act Section <b>203</b>
<b>PA Programs</b>	<b>HMA Programs</b>		
<b>Disaster-related programs</b>	<b>Disaster-related programs</b>	<b>Non-disaster-related programs</b>	
 <p><b>PA:</b> Mitigation of incident-caused damage</p> <p>Funding: Available for disaster-damaged facilities only*</p>	 <p><b>HMGP:</b> Multi-hazard, statewide mitigation</p> <p>Funding: Available for damaged and non-damaged facilities based on a percentage of dollars obligated to the PA and IA programs</p>	 <p><b>FMA:</b> Flood mitigation for insured properties</p>	 <p><b>PDM:</b> Multi-hazard, project-specific</p>
<p>NOTE: PA = Public Assistance HMA = Hazard Mitigation Assistance HMGP = Hazard Mitigation Grant Program</p>		<p>FMA = Flood Mitigation Assistance PDM = Pre-Disaster Mitigation IA = Individual Assistance</p>	

\* See exception for Alternative Procedure Projects in Chapter 2, Section VII.G.4(c).

Figure 5-1: FEMA hazard mitigation programs (Federal Emergency Management Agency 2017a).

In December 2016, four federal agencies, including FEMA, provided the project team with grant data related to natural hazard mitigation for flood, wind, earthquake, and fire at the WUI. Table 5-1 lists the

<sup>24</sup> See <https://www.fema.gov/media-library/assets/documents/15271>.

<sup>25</sup> See <https://www.fema.gov/media-library/assets/documents/7277>.

## NATURAL HAZARD MITIGATION SAVES:

federal agency programs that provided grant data. Agencies tend to keep the relevant data in their own agency-specific formats; the project team merged their data into a single database with fields listed in Table 5-2. The data contained many gaps for fields that agencies do not compile or could not provide for fear of releasing personally identifiable information. Table 5-3 summarizes quantities of mitigation grants examined here. Not all of the data could be used. Some records lacked sufficiently fine geolocation information. In some cases, the project team could not determine that the record actually dealt with natural hazard mitigation. Some projects took place outside of the 48 contiguous states.

The data offer grant project amounts in grant-year dollars. The project team adjusted the totals to account for inflation using a deflator calculated as the ratio of grant-year per-capita U.S. GDP PPP, provided by the World Bank. Total project costs are shown in Table 5-4. The table reflects removing grants that could not be used or did not appear to address natural hazard mitigation, and accounts for inflation using the GDP PPP deflator. Table 5-5 presents median and mean project amounts by peril in grant-year dollars. Figure 2-1 shows the distribution of flood project amounts. Figure 5-3 shows the distribution of wind projects, Figure 5-4 earthquake projects, and Figure 5-5 fire projects.

**Table 5-1:** Agencies and programs providing grant data.

Agency	Program
EDA	Disaster Mitigation Recovery
	Hurricane Floyd disaster 2001
	Other disasters using Floyd emergency fund 2001
	Norton Sound, Alaska 2001
	2008 Disaster Supplemental I, including Midwest Floods
	2008 Disaster Supplemental II, including Midwest Floods
	2010 Gulf Oil Spill Disaster Supplemental
	2010 Disaster Supplemental
	Federally declared disaster area
	Hurricane Katrina Disaster 2005
	Gulf Coast Disaster 2010
	Alaska Fisheries Disaster
	2012 Disaster Supplemental
	2010 Gulf Oil Spill Disaster Supplemental
	2008 Disaster Supplemental I
	2010 Disaster Supplemental
	2008 Disaster Supplemental II
	Global Climate Change Mitigation Incentive Fund

## NATURAL HAZARD MITIGATION SAVES:

Agency	Program
DOT	
FEMA	Flood Mitigation Assistance (FMA) Grant Program
	Hazard Mitigation Grant Program (HMGP)
	Public Assistance (PA) Program
	Pre-Disaster Mitigation (PDM) Grant Program
HUD	Community Development Block Grant Program (CDBG)

**Table 5-2:** Integrated project database format.

Field	Meaning	Example
ID	2017 Mitigation Saves study unique integer ID	11123
DB	Program: FMA, HMGP, PDM, PA, HUD, or EDA. SBA data had no info on natural hazard mitigation. DOT had too few building projects.	HMGP
DBID	2017 Mitigation Saves study integer ID within DB	15104
Region	FEMA region	
StateName	State name or state postal abbreviation	California
DisasterNumber	Disaster number	
DeclarationDate	Declaration date	
IncidentType	Incident type	
Peril	Peril for purposes of 2017 <i>Mitigation Saves</i> study	Earthquake
DisasterTitle	Disaster title	
ProjectNumber	Project number	DR-1008-3034-R
ProjectType	Project type	205.4: Non-Structural Retrofitting/Rehabilitating Public Structures – Seismic
ProjectTitle	Project title	Seismic Retrofit (Replacement) of Electrical Stations

## NATURAL HAZARD MITIGATION SAVES:

Field	Meaning	Example
ProjectDescription	Project description	
ProjectCounties	Project counties	Los Angeles
Status	Grant status	Closed
Subgrantee	FEMA subgrantee	
SubgranteeFIPSCode	Subgrantee FIPS code	
ProjectAmount	Project amount \$	126524100
CostSharePercentage	Cost share percentage	58
CountyFIPS5	County FIPS5	06037
PerilOK	Peril is within <i>Mitigation Saves Volume 2</i> scope	TRUE
HazOK	County has hazard info available	TRUE
StatusOK	Project status suggests the project was actually undertaken	TRUE
WindHaz	Wind hazard level H M or L	L
WUIFireHaz	WUI fire hazard level H M or L	M
FloodHaz	Flood hazard level H M or L	L
EqkHaz	Earthquake hazard level H M or L	H
StructureType	Structure type	
FoundationType	Foundation type	
PropertyPartOfProject	Property is part of project	Yes
StructureLocatedInFloodway	Structure is located in floodway	
FloodZone	Flood zone	
FloodSource	Flood source	
PostMitigationPropertyUse	Post-mitigation property use	
Latitude	Latitude decimal degrees N (truncated to 3 decimal places)	34.180
Longitude	Longitude decimal degrees E (truncated to 3 decimal places)	-118.445
FirstFloorElevation	First floor elevation ft	
YearBuilt	Year built	
StreetName	Street name	AETNA STREET
City	City name	VAN NUYS
ZIP	ZIP code	91401

**Table 5-3:** Summary of grant data, in grant-year dollars.

Agency	Program	Project dates	Peril	Projects	Properties	Amount (\$M)
EDA	Various	2000-2016	Flood	159		\$ 800
			Wind	67		\$ 200
FEMA	FMA	1993-2016	Flood	1,063	2,873	\$ 789
	HMGP	1993-2016	Earthquake	558	3,986	\$ 2,470
			Fire	23	108	\$ 22
			Flood	4,355	30,288	\$ 7,022
			Wind	3,816	20,446	\$ 3,061
			HMGP subtotal		54,828	\$ 12,575
	PA	2001-2016	Earthquake	457		\$ 29
			Fire	83		\$ 3
			Flood	9,672		\$ 168
			Wind	13,613		\$ 5,534
			PA subtotal	23,825		\$ 5,734
	PDM	1993-2016	Earthquake	87	424	\$ 286
			Fire	13	392	\$ 15
			Flood	239	1,345	\$ 441
			Wind	175	205	\$ 171
			PDM subtotal		2,366	\$ 913
			FEMA total		60,067	\$ 20,011
HUD	CDBG	2001-2015	Flood	99		\$ 92

**Table 5-4:** Total project costs in billions.

Peril	Cost (billions)
Riverine flood	\$ 11.50
Wind	\$ 13.60
Earthquake	\$ 2.20
Fire at WUI	\$ 0.06
<i>Subtotal, grants</i>	<i>\$ 27.4</i>

**Table 5-5:** Median and mean project amounts in project-year dollars.

Peril	Median	Mean
Flood	\$ 33,000	\$ 640,000
Wind	\$ 23,000	\$ 990,000
Earthquake	\$ 168,000	\$ 1,700,000
Fire	\$ 39,000	\$ 380,000

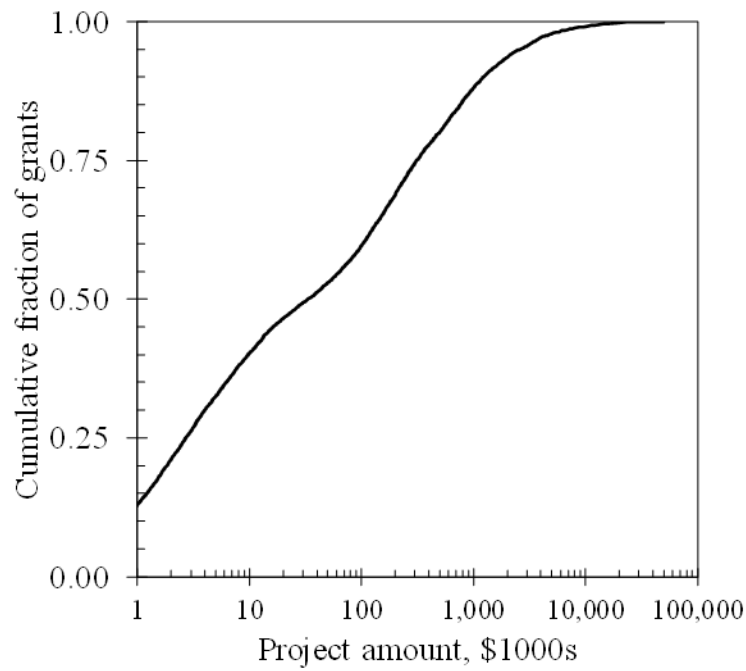

**Figure 5-2:** Flood project amounts in thousands of grant-year dollars.



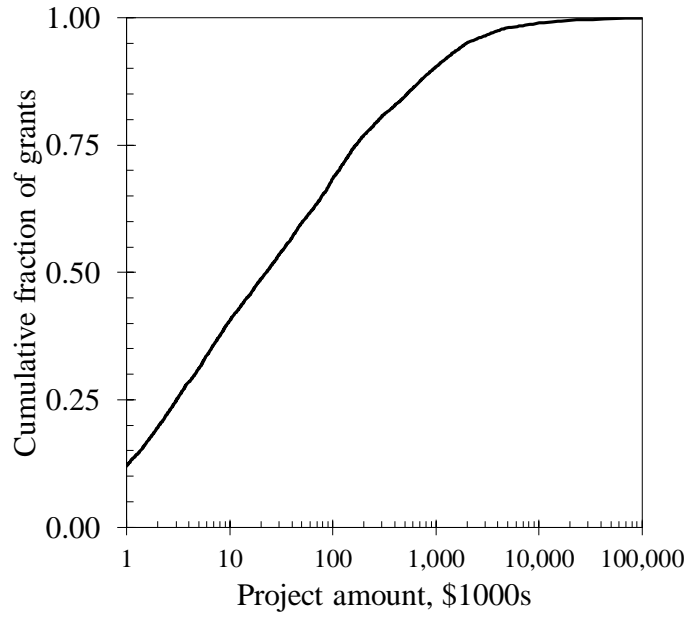

Figure 5-3: Wind project amounts in thousands of grant-year dollars.

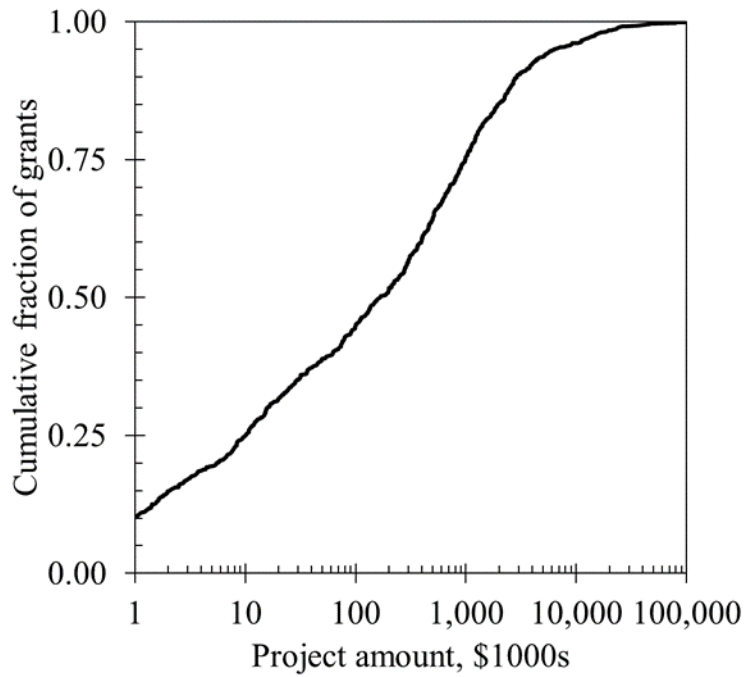

Figure 5-4: Earthquake project amounts in thousands of grant-year dollars.

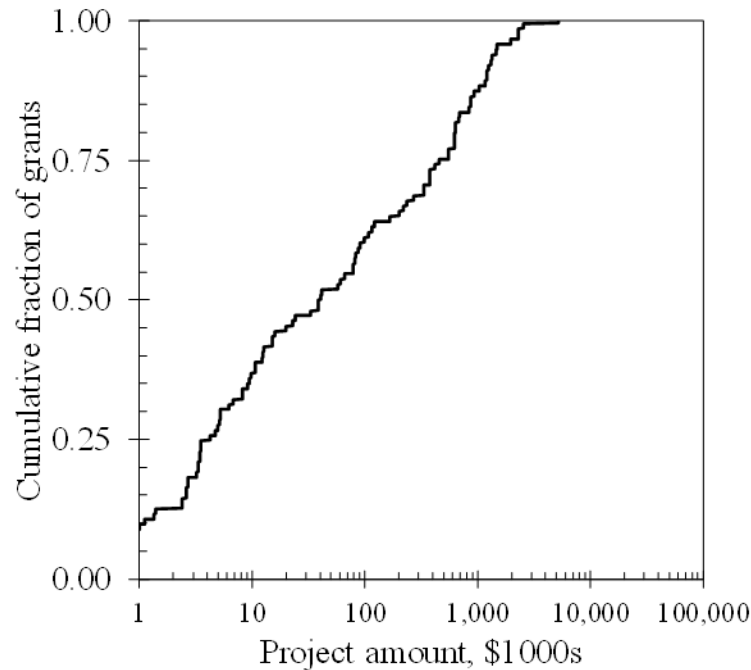

Figure 5-5: Fire project amounts in thousands of grant-year dollars.

## 5.2. ADOPTING I-CODE REQUIREMENTS FOR RIVERINE FLOOD

This section addresses the calculation of the cost effectiveness for incorporating the freeboard requirements in the 2018 I-Codes. Rather than using a Hazus-based approach, the project team determined the cost effectiveness using a modified version of FEMA's BCA software and applying a building inventory of both commercial and single-family residential buildings to a variety of floodplain cross sections. The benefits, costs, and overall BCRs for the various floodplain cross sections were then adjusted using a weighted average approach to represent to approximate percentage of each of the floodplain cross sections throughout the United States. The results were further adjusted to address the potential number of structures of each type to be constructed within a year in areas that currently do not utilize freeboard through either adoption of the I-Codes or through a floodplain management ordinance.

### 5.2.1. Building Inventory for Below-Code Design for Riverine Flood

As discussed in Section 4.4.2, the building types consisted of four commercial building types with three different building sizes and six different construction methods. The variation in building size and construction approach impacted factors such as the length of building perimeter and cost variations in mitigation measures such as dry floodproofing to increase the sample size and provide a larger overall data set from which to understand the cost effectiveness of freeboard. Residential buildings were similar in

## NATURAL HAZARD MITIGATION SAVES:

using both one-story and two-story homes of two different sizes with four different construction methods in order to add variation in the building perimeter and cost of construction.

To develop building replacement costs for the below-code designs, RSMeans CostWorks 2018 data was applied to each of the building sizes and types. Since the analysis did not represent any one specific location, the national average values were used for all calculations. The value of contents in the buildings were applied based upon the designation from the DDF associated with the building type. Most of the Hazus DDFs use 100% of the building value. The percentage values in the contents DDFs were adjusted in order to allow the 100% value to be used in order to ease the calculation development. Loss of use or displacement values are the other primary value used in the initial calculations. While building damages and contents damages for multi-story office buildings were only applied to the first floor, the loss of use values were applied to the entire square footage. The project team studied the average square footage per person for multiple office buildings and used 312 square feet per worker for office buildings. Workers' lost wages were used on a per person basis. A salary of \$35,000 per worker per year was used to calculate the value of loss of use. For retail space an annual revenue of \$200 per square foot was used to determine the value of loss of use. Finally, warehouse spaces used a value of \$7.50 or approximately 3.75% of the annual revenue of retail spaces. This value was determined using comparisons of the value of warehouse space as compared to retail space. Single-family residential buildings used a simplified approach of 2.5 occupants per buildings, where each day of displacement from the home would allow for \$77 per house for a hotel room and \$46 per person per day for meals. This methodology is consistent with the current FEMA BCA approach.

### 5.2.2. Cost to Comply with 2018 I-Codes for Riverine Flood

The project team determined the costs to comply with the one-foot freeboard requirements of the I-Codes based on the mitigation measure using RSMeans CostWorks 2018 data. These costs were developed for each mitigation approach for compliance and calculated for multiple square footages of buildings with associated perimeters (per the RSMeans square foot models) in order to allow for multiple building footprints to be evaluated in an automated approach.

The cost to elevate a building to comply the 2018 I-Codes includes construction of the foundation walls one foot higher, and associated extensions to electrical, water, and wastewater risers. In building with stemwall foundations, the cost also includes placing compacted fill within the stemwall. The project team evaluated residential crawlspaces for the addition of one foot of reinforced masonry walls. The cost also included adding one foot to the columns on the interior of the footprint. The number of such columns were estimated based on the size of the building footprint, using common framing practices.

The project team evaluated dry floodproofing costs by using the construction type for each commercial building type, the construction approach, average number and size of openings, and number of feet of perimeter wall in order to calculate a square footage of area that must be designed to be waterproofed and resist flood loads, as well as consideration of costs for shields to protect openings such as doors and

windows. Additional costs were developed to address an interior drainage system and backflow prevention valves, which are necessary in the design of any comprehensive dry floodproofing measure. The costs to dry floodproof were developed using RSMean CostWorks 2018 and feedback from vendors that provide dry floodproofing products. Only commercial buildings were evaluated with dry floodproofing since it is not an allowable protection measure for residential buildings. An annual maintenance value of approximately 1% of the total value of construction was applied to any dry floodproofing costs over the life of the building in order to make sure that mitigation effectiveness could be maintained. Annual maintenance costs were assumed to be nominal for elevated buildings since the study is only evaluating the cost of freeboard for buildings already located in the SFHA.

### 5.2.3. Benefits of Complying with 2018 I-Codes for Riverine Flood

The calculation of benefits required development of hypothetical flood conditions, calculation of potential damages for below code building, calculation of damages for buildings meeting the I-Codes, and then comparison of damages and calculated costs of construction. This section will provide background on the approach used to calculate each of these values and how the benefits and costs were adjusted so they would represent the potential national exposure for flooding in communities that have not adopted the I-Codes.

In order to calculate the benefits associated with adoption of the I-Codes it was necessary to evaluate the cost effectiveness of constructing buildings to one-foot of freeboard in a variety of conditions. In order to develop a variety of floodplains a series of hypothetical floodplain cross sections were developed using the data from the PELV500 (Water Depth Probability Curve) formulas used to designate Numbered A Zones (A01-A30). The PELV 500 formulas are used as a step in the Actuarial Methods and Assumptions for the flood insurance rating component of the NFIP. The PELV 500 formulas indicate the Average Depth Exceedance Difference between the 1% and the 10% flood events. This depth difference in feet can be used to create an idealized floodplain cross section. Correlating the elevation (normal) to the recurrence interval (natural log) the elevations for the 2% and 0.2% floods can be calculated. Table 5-6 provides a summary for each numbered A-zone, the difference in elevation between the 1% and 10% annual chance flood, an approximate percentage of each zone, and they hypothetical elevation for four flood events. They hypothetical elevations do not represent any specific location but are used to provide differences in elevation between each flood event, so damages can be calculated on the building inventory. While this approach assumes that the slope of the floodplain is constant, it does allow an analysis of a variety of floodplains to be conducted without needing flood data for every floodplain throughout the United States. The associated weighting factors were used in order to represent the rounded percentage of buildings within the floodplain. Once a BCA was conducted for all the building types in each of the floodplains then the weighting factors were applied to the BCRs. These weighting factors allow the benefits to be applied based on the approximate percentage of each of these idealized floodplain cross sections across the country.

**Table 5-6:** Table of hypothetical elevations for idealized floodplains.

Numbered A zones	Difference between 10-year and 100-year	Weighting factor for analysis	Hypothetical elevations for annual percent chance of flooding			
			10%	2%	1%	0.2%
A01	0.5	1%	29.5	29.85	30	30.35
A02	1	1%	29	29.7	30	30.7
A03	1.5	1%	28.5	29.55	30	31.05
A04	2	3%	28	29.4	30	31.4
A05	2.5	6%	27.5	29.25	30	31.75
A06	3	8%	27	29.1	30	32.1
A07	3.5	10%	26.5	28.95	30	32.45
A08	4	11%	26	28.8	30	32.8
A09	4.5	11%	25.5	28.65	30	33.15
A10	5	11%	25	28.49	30	33.49
A11	5.5	10%	24.5	28.34	30	33.84
A12	6	9%	24	28.19	30	34.19
A13	6.5	7%	23.5	28.04	30	34.54
A14	7	6%	23	27.89	30	34.89
A15	7.5	4%	22.5	27.74	30	35.24
A16	8	3%	22	27.59	30	35.59
A17	8.5	2%	21.5	27.44	30	35.94
A18	9	1%	21	27.29	30	36.29

As discussed in Sections 5.2.1 and 5.2.2, the input data was created using an approach that used the selected building inventory and flood data to create input values for the BCA. This used an automated analysis to calculate costs for building replacement values, mitigation values, and other inputs for each of the flood scenarios to be evaluated. Additional freeboard amounts were also considered in order to make sure that common trends with the cost effectiveness of freeboard were being maintained and this provided another check of the model for the analyst and the reviewer. During this step additional factors such as the daily loss of use were added for each building type based on the use and size of the building.

DDFs for each building type were selected and compared based upon an evaluation of all the applicable Hazus DDFs, FEMA BCA Software DDFs, and those developed for the USACE’s *North Atlantic Coast Comprehensive Study: Resilient Adaptation to Increasing Risk—Physical Depth Damage Function Summary Report* (January 2015). Following this analysis, it was determined that the standard DDFs used in Hazus for each commercial building type were appropriate and neither represented the upper or lower-bound, but

## NATURAL HAZARD MITIGATION SAVES:

a midrange of expected damages. Note: for office buildings, the same DDF was selected. The damages for the 3-story office building were attributed to only the first floor of the building for both the building/structural damages and the damage to building contents. For the displacement or loss of use the entire 3-story building occupancy was considered. During the analysis flooding below the lowest floor was not considered since the NFIP requires that all materials below the lowest floor be flood damage resistant materials. Since this is required with the incorporation of freeboard, this approach was maintained in the code compliant analysis.

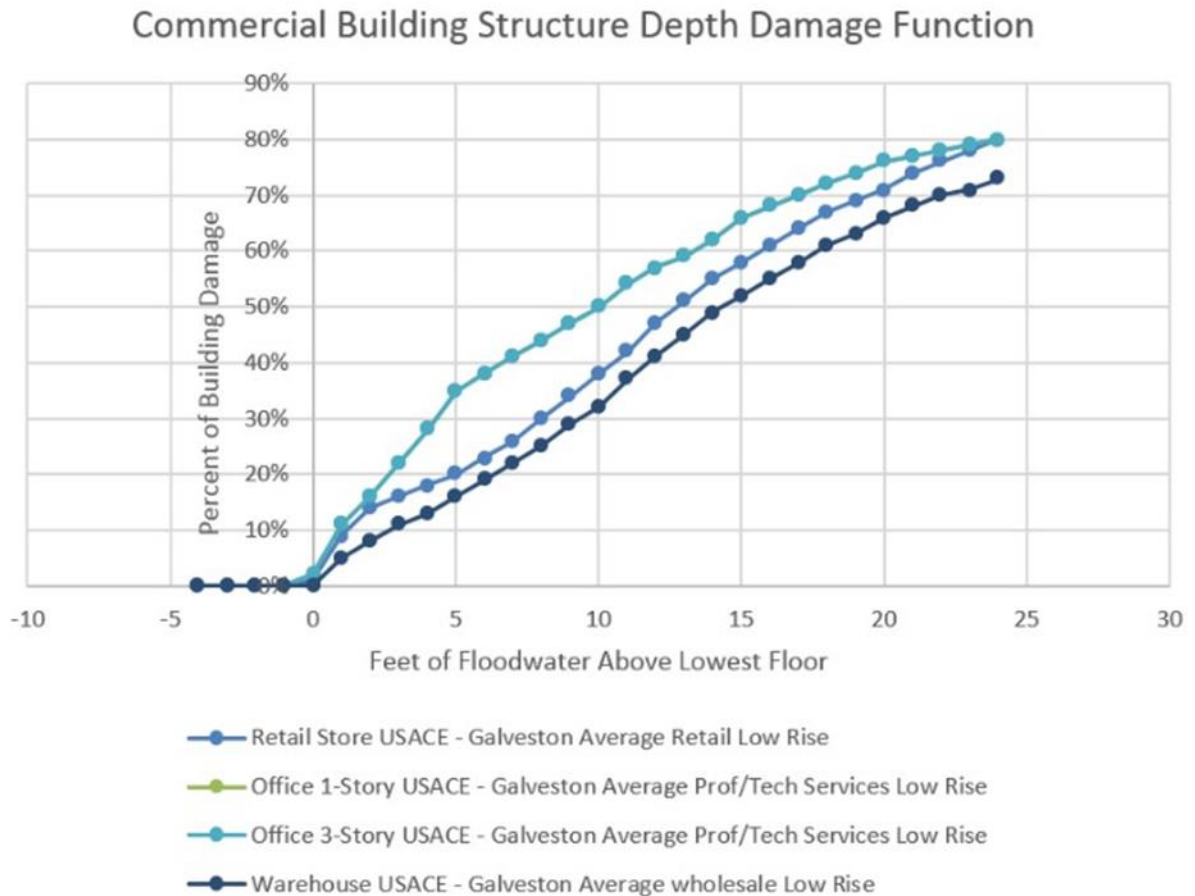

Figure 5-6: Commercial building depth-damage functions used for analysis.

The analysis of DDFs for single-family residential buildings were conducted using the same approach to the commercial buildings. Figure 5-7 and Figure 5-8 show the compilation of some of the DDFs reviewed for the one-story and two-story single-family buildings. Many of these existing DDFs represent existing construction that have elements below the lowest floor that have not been constructed of flood damage resistant materials. This results in DDFs that represent buildings constructed on crawlspaces to overestimate damages since elements such as insulation, ductwork, wiring, and other building elements would be damaged by floodwater before it reaches the lowest floor on existing buildings, but the NFIP requirements would largely eliminate this factor. It was therefore decided that the USACE – New Orleans:

## NATURAL HAZARD MITIGATION SAVES:

one-story slab foundation curves for freshwater short duration flooding would best represent one-story buildings and the USACE – New Orleans: two-story slab foundation curves for freshwater short duration flooding would best represent two-story buildings. The BCA software was further adjusted to eliminate any damage below the lowest floor to avoid interpolation between -1 foot below the lowest floor and 0 or the lowest floor elevation. Curves for loss of contents and displacement were applied in the same fashion, but without any further adjustment.

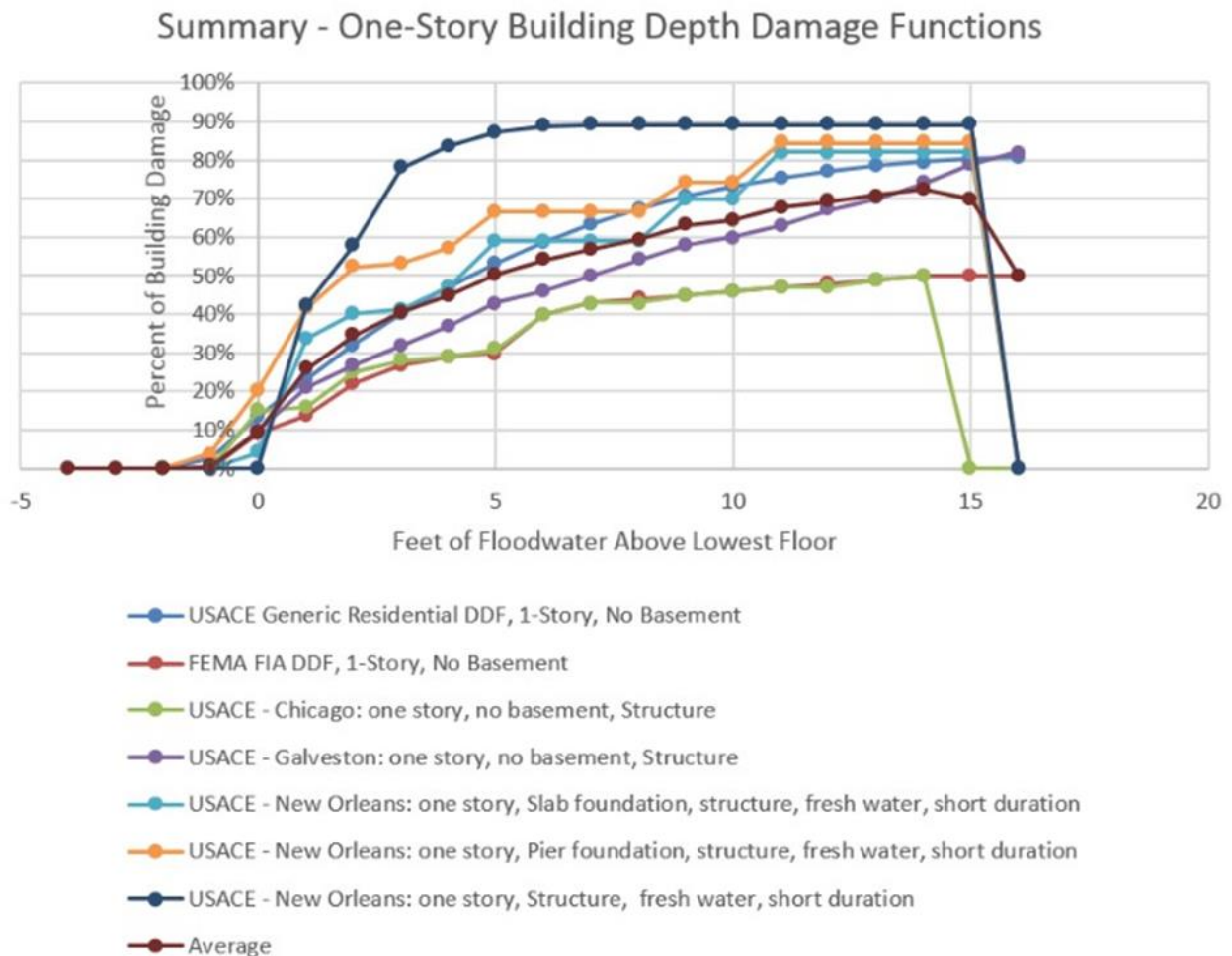

Figure 5-7: One-story single-family building depth damage function compilation example.

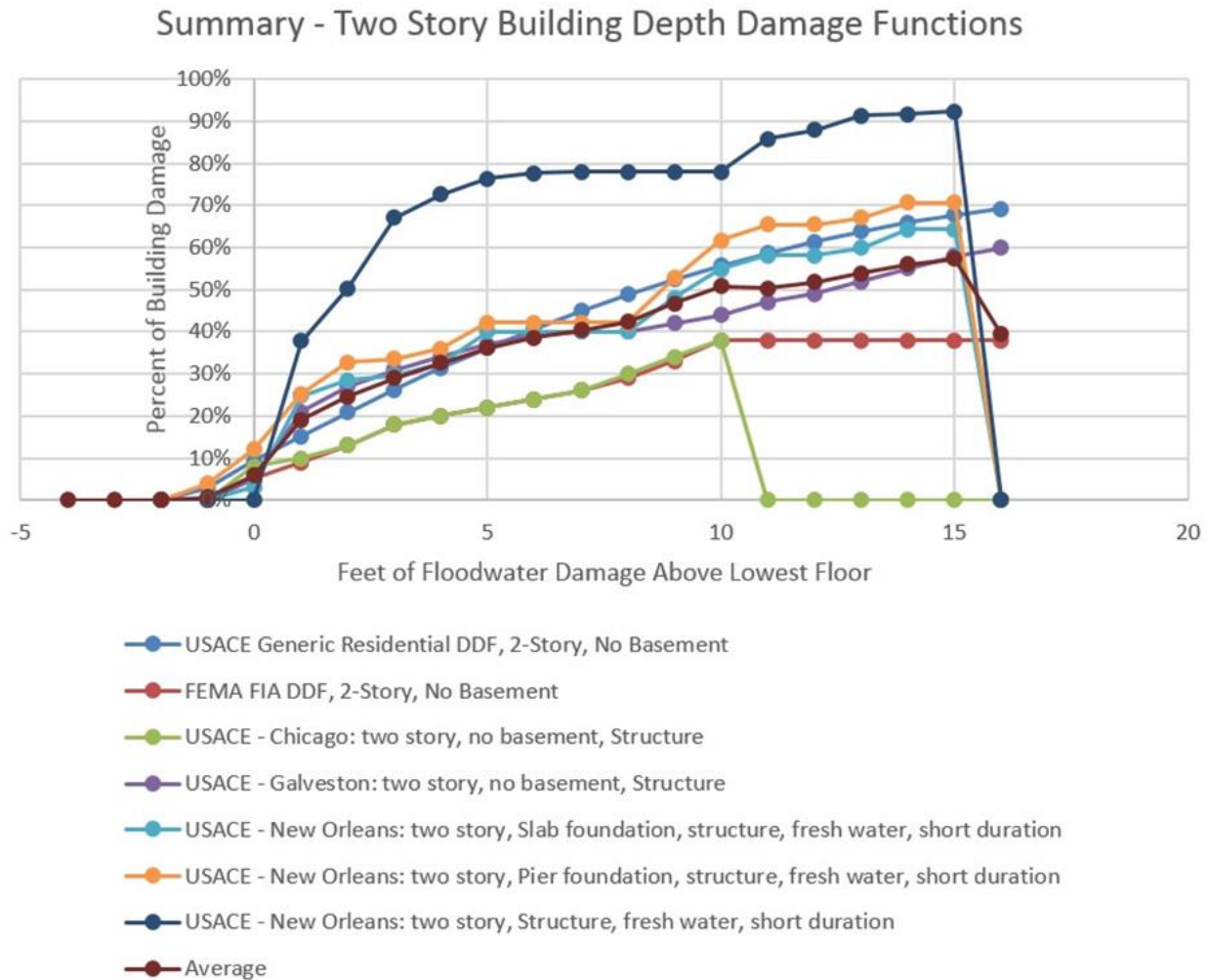

Figure 5-8: Two-story single-family building depth damage function compilation example.

The data were input into a model matching the approach of the FEMA BCA Software 5.3 Flood Module to calculate damages to the buildings in a below-code and I-Code compliant condition. Since flood data typically does not exceed the 0.2 percent annual chance flood event, the highest recurrence interval flood event considered for damages was the 0.2 percent annual chance event. Although it is possible for flood events to exceed this level, it is not normally considered. Doing so would require recreating this study using the FEMA BCA software. Flood data for Numbered A Zones A01-A30 were calculated but sorted to only Zones A01-A18, since these are the more common floodplains where buildings are constructed. Calculated damages for both conditions as well as input data were output to a summary file to apply the weighting factor outlined in Table 5-7. In the table, FMI refers to FMI Corporation, an engineering consulting company. For each of the buildings outline in the building inventory, a revised BCA as well as costs and benefits were compiled. This data was output into data analytics software (QlikView) to expedite evaluation of the results. QlikView allowed the average benefits, cost, and BCR to be calculated for each building type and further sorting based on construction type and mitigation approach.



## NATURAL HAZARD MITIGATION SAVES:

This procedure provides a national average (unitless) BCR for newly constructed buildings within the floodplain. Additional calculations were required to calculate the total dollar values of costs and benefits for new buildings constructed within the SFHA in communities that do not recognize freeboard. A determination of approximate construction starts for each building type will provide an overall value of construction. A national assessment of construction indicated that approximately 13% of buildings in the United States are constructed in floodplains. In order to approximate the percent of those buildings that are constructed in communities that do not currently require freeboard a 2015 study from ASFPM was used, which indicated that 38% of the U.S. population live in areas that do not have a freeboard requirement for buildings constructed in the SFHA. These reductions allowed the calculation of the approximate dollar value of buildings constructed in the floodplain not subject to freeboard requirements. For each building type the percent increase in construction cost was applied to the total cost of construction. This value allowed for calculation of the cost of freeboard per building type. The cost of construction was multiplied by the BCR per building type in order to calculate the benefits for each building type. The costs and benefits for each building type were summed in order to derive a nationwide cost and benefit for incorporating freeboard into the remaining communities that do not require freeboard. The benefits were divided by the costs to calculate an aggregated BCR for the represented building types. Table 5-8 illustrates the values associated with each of these steps.

**Table 5-7:** Value of 1 year of new construction in the floodplain.

Building types	FMI (2017) US Markets Construction Overview			Value in floodplain	Value in areas without Freeboard
	Starts	Value (\$ million)	Total estimated value for 2017 (\$ billion)	13% of US buildings in SFHA (\$ billion)	38% of communities have no freeboard
Offices	72,329	1.0	\$72.3	\$9.6	\$1.3
Commercial	76,974	1.0	\$77.0		
Retail*	57%		\$43.9	\$5.8	\$0.8
Warehouse*	43%		\$33.1	\$4.4	\$0.6
Single family	263,868	1.0	\$263.9		
1 Story*	58%		\$153.0	\$20.4	\$2.7
2 Story*	42%		\$110.8	\$14.7	\$2.0

\*Assumed percentages based on square footage for each building type within an FMI category

**Table 5-8:** Benefit from 1 year of nationwide incorporation of freeboard through adoption of the I-Codes.

Building type	Value in areas without freeboard (38%) (\$ billion)	Increase	Cost (\$ million)	BCR (2.2%)	Benefit (\$ million)
Offices	1.3	0.85%	10.9	5.1	55.5
Retail	0.78	1.80%	14.0	3.8	53.1
Warehouse	0.59	1.30%	7.6	4.1	31.1
Single family					
1 story	2.7	1.40%	37.9	6.2	236.5
2 story	2.0	1.20%	23.5	5.8	135.7
Total (2.2% discount rate)			93.9	5.4	511.9

While the Interim Study focused on the cost effectiveness of incorporating freeboard when the modeled flood conditions are static and known, there are likely more benefits for freeboard in actual floodplains. The BCA and Hazus approaches assume that flood conditions are constant over the life of the building and that the recurrence interval for each flood event is well defined. When either changes in conditions or improvements in modeling indicate that higher flood elevations occur more frequently, then freeboard becomes even more effective. Adjustments to the discount rate to either 3% or 7% result in overall BCRs of 5.0 and 3.6 respectively, indicating that even with more conservative discount rates freeboard is still cost effective. The benefits of incorporating freeboard should be even higher if other building types within communities such as schools and critical facilities were incorporated, since those buildings would be subject to the requirements of ASCE 24 and with respect to critical and essential facilities required to incorporate additional freeboard to address community resilience.

## 5.3. DESIGNING TO EXCEED I-CODE REQUIREMENTS FOR RIVERINE FLOOD

### 5.3.1. Building Inventory for Above-Code Design for Riverine Flood

Hazus Release 3.2 represents building exposure in both aggregate and site-specific form. The aggregated building inventory, referred to as GBS, is reported at the level of 2010 census blocks while the UDFs are reported as points. One improvement in Hazus pertains to the way that it represents buildings in the GBS. A fundamental assumption of the GBS is that all buildings are evenly distributed within a given census block. In the version of Hazus available at the time of the *2005 Mitigation Saves* study, census blocks were

## NATURAL HAZARD MITIGATION SAVES:

clipped to remove water bodies. However, they still often overlapped areas where buildings were unlikely to be constructed such as locations that were predominantly forested or vacant.

The current release of the Hazus flood model applies a dasymetric adjustment methodology that has been used to refine census block boundaries by removing these areas. Figure 5-9 illustrates an area that has been overlain with dasymetrically modified 2010 census block boundaries. Note that large portions of this image contain forested land with no structures. While these boundaries do not necessarily reflect a precise depiction of where structures do and do not exist in every community, they generally provide a more realistic representation of building locations within a community than did the boundaries used in earlier Hazus flood model releases, including the one used in the *2005 Mitigation Saves* study.



**Figure 5-9:** Example of dasymetrically adjusted census block polygons.

UDF inventory is developed from user-supplied information that describes the structural design and occupancy characteristics of individual buildings. It is not intended to provide a detailed assessment of mitigation impacts on a single structure, but when viewed as a portfolio of building points—as is the case with the Interim Study—it offers a much more refined assessment of the impact of mitigation than is otherwise possible. UDF-based outputs include estimates for building damage percent and dollar loss; content damage percent and dollar loss; and inventory dollar loss. All structure categories that are represented in the GBS can also be modeled as part of the UDF inventory. Ideally, UDF structures are located at the centroid or even the lowest adjacent grade of a structure. However, that type of inventory can only be created if suitable data resources are available.

In the analysis of above-code design requirements pertaining to riverine floods, the project team used a combination of the Hazus UDF inventory and the Hazus GBS Inventory. The tools developed to generate the UDF inventory placed the locations at the centroid of parcels. Figure 5-10 provides a hypothetical example of UDF inventory.

Occupancy – IND 2  
Area – 110,000  
Building Cost – \$5,000,000  
Content Cost – \$1,000,000  
Type – Concrete  
Foundation – Slab

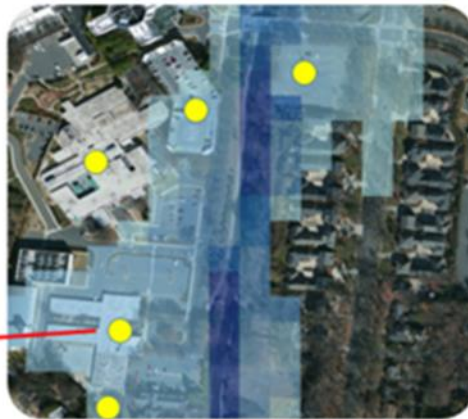

Figure 5-10: Example of UDF inventory.

### 5.3.2. Cost of Designing to Exceed I-Code Requirements for Riverine Flood

The project team calculated the cost to build new single-family dwellings at multiple elevations at and above I-Code requirement using the CostWorks U.S. national averages reported in RSMeans construction cost estimates as of February 2017. The project team estimated costs accounting for the following:

- Different types of foundation were addressed: concrete masonry unit walls and piers, poured concrete walls and piers, concrete masonry unit piers, stemwall, and fill.
- Cost calculation took into account material cost, equipment, and labor required for the construction of a one-foot addition to a foundation during the construction process consisting of concrete masonry units (186 SF).
- Costs were calculated for four types of building sizes (1,500 and 3,000 square feet with foundation size 30 feet by 50 feet, also 2,400 and 4,800 square feet with foundation size 40 feet by 60 feet). Pier spacing was calculated using common lumber framing sizes and joist lengths.
- The project team included the cost of compliance with the ADA: ramps with a 1:12 slope and appropriate allowances for landings.
- Final cost estimates were summarized by closed and open foundation calculations as well as building types (8 types of estimates are provided). These were added to the building replacement value to estimate the total cost of constructing a new structure with X foundation height.
- Cost estimates were multiplied by a locational factor to account for regional difference.

Table 5-9 lists the cost estimates used for the 8 variations of building size and foundation types that were generated using the above listed information. The figures include compliance with additional features required by the ADA. These costs may seem low. However, that it is usually far less expensive to build better initially than to retrofit existing buildings to the same level of resistance.

**Table 5-9:** Estimated costs to build new buildings higher to reduce risk from riverine flood.

Code	Estimated national cost to build to higher elevation, per house					Adjustment factor	
	BFE + 1	BFE + 2	BFE + 3	BFE + 4	BFE + 5	Georgia	Indiana
A	\$ 883	\$ 1,766	\$ 2,688	\$ 3,571	\$ 4,493	0.81	0.93
B	\$ 1,636	\$ 3,271	\$ 4,907	\$ 6,542	\$ 8,332	0.81	0.93
C	\$ 883	\$ 2,159	\$ 2,727	\$ 3,610	\$ 4,532	0.81	0.93
D	\$ 1,636	\$ 3,271	\$ 4,907	\$ 6,542	\$ 8,332	0.81	0.93
E	\$ 1,203	\$ 2,405	\$ 3,663	\$ 4,866	\$ 6,124	0.81	0.93
F	\$ 2,168	\$ 4,336	\$ 6,505	\$ 8,673	\$11,048	0.81	0.93
G	\$ 1,203	\$ 2,461	\$ 3,719	\$ 4,921	\$ 6,179	0.81	0.93
H	\$ 2,168	\$ 4,336	\$ 6,505	\$ 8,673	\$11,048	0.81	0.93

### 5.3.3. Life-Safety and Additional Living Expense Benefits of Designing to Exceed I-Code Requirements for Riverine Flood

To estimate benefits of designing to exceed I-Code requirements in terms of reduced deaths, injuries, PTSD, and ALE, the project team took the reduction in loss as proportional to the reduction in building and content losses for single-family dwellings (RES1). See Section 5.4.3 for some additional analytical details common to above-code design and mitigation grants.

## 5.4. GRANTS FOR RIVERINE FLOOD MITIGATION

### 5.4.1. Building Inventory for Flood Mitigation Grants

For the analysis of public-sector grants, the Interim Study applied two types of Hazus inventory for the analysis: UDF and GBS. The following guidelines were applied to develop a Hazus-compliant GBS and UDF building inventory from information contained in the grant database.

**Occupancy.** The StructureType field in the grants database contained information on structure use. Hazus occupancy classes are mapped as shown in Table 5-10.

**Table 5-10:** Mapping from grants database to Hazus occupancy classes for riverine flood.

Structure type	Hazus occupancy
2-4 family	RES3A (duplex). Note that Hazus breaks 2-4 units into two classifications, RES3A and RES3B. It was not possible to differentiate which is correct from the data in the database, therefore RES3A is used.
Manufactured home	RES2 (manufactured housing)

## NATURAL HAZARD MITIGATION SAVES:

Single family	RES1 (single-family dwelling)
Blank	RES1 (single-family dwelling), the most common type in the database

**Location.** The project team used both the GBS and the UDF inventories in the completion of public-sector grant analysis. Thus, each inventory type had to be modified based on the information provided in the grant record to reflect the location as well as associated attributes for each acquired building.

The grant database contained multiple records and coordinates for a single grant. The project team assumed that each record represented a single building in the grant. Locations of UDFs, which were used in the calculation of building and content losses for acquired structures, were located at the coordinates specified in the grant database where possible. However, in a few instances it was necessary to move one or more of these building points. In such instances, the new location was made to be as close to the original location as possible.

The final building location for each acquired building was based on three criteria. First, it had to be within the 100-year depth grid inundation area generated by Hazus, since it was assumed that the structure may not have been acquired due to flooding at lesser return periods. Second, it had to be located within one of the dasymetric census block boundaries. This was necessary to allow for the calculation of losses that had to be derived from the GBS inventory, which only applied to these boundaries. Finally, it had to be in a location where the depth of water to which the structure was exposed exceeded the building first floor elevation for the 100-year return period.

**Cost.** The Indiana State Hazard Mitigation Officer told the project team that for the 31 FEMA grants for demolition and acquisition of Indiana buildings between 2007 and 2017, communities spent \$21 million of \$32 million (67.8%) awarded. When reviewed individually, this percentage was consistent across most of the individual projects. Only two small outliers had higher percentages. The project team was torn about whether to apply this fraction across the board, just to Indiana grants, or not at all. The project team lacked the resources to check with other state hazard mitigation officers. FEMA staff had assured the project team that the project amounts in the database were their best estimates of actual project costs. To assume that all other grants were similarly less costly than the grant database indicated would tend to reduce costs and increase BCRs. To apply the fraction to just the Indiana grants would add a degree of inconsistency and would also increase the BCR. The project team selected the most conservative of the three options and used the grant amount in the FEMA database to estimate BCRs.

**Building count.** The grant database provided a count of buildings that were categorized as Hazus occupancies RES1, RES2, or RES3A. Using this information, the project team created a UDF inventory representing acquired structures. The project team also updated the GBS building counts for each census block in which an acquisition occurred.

**Square footage.** The grant database did not contain building square footage, but Hazus requires this value for the calculation of selected types of losses. The project team used the Hazus occupancy classes and applied the average building areas assumed by Hazus Release 3.2, as shown in Table 5-11.

## NATURAL HAZARD MITIGATION SAVES:

Using the calculated buildings areas, the project team updated both the UDF inventory and the GBS. Values applied to UDF were building-specific, based on the criteria above. Values applied to the GBS were cumulative based on the quantity of each type of structure. For example, if a grant included 2 RES1 buildings in the same census block, the project team adjusted the building square footage for that census block in the pre-mitigation analysis to add 3,600 square feet to the RES1 square footage table (e.g., 2 x 1,800 square feet).

**Building replacement cost.** Hazus requires a building replacement cost to calculate flood losses. However, project amounts in the grant database were based on pre-damaged appraised value. They do not reflect the replacement cost of buildings acquired. For this reason, the project team applied a methodology similar to that used to develop the default Hazus inventory. In that methodology, default replacement costs are based on building square footage multiplied by RSMean construction values and then further adjusted to reflect regional variations. Table 5-12 shows how the project team estimated building replacement costs. The project team assumed uniform replacement costs within an occupancy class. For example, if total RES1 building replacement cost was estimated to be \$1 million for 10 single-family dwellings (RES1), each was taken to have a replacement cost of \$100,000. Table 5-13 shows the Hazus assumed square-foot costs.

**Table 5-11:** Hazus estimates of average building area.

Occupancy	Square footage
RES1	1,800
RES2	1,475
RES3A	2,200
RES3B	4,400
RES3C	8,000
RES3D	15,000
RES3E	40,000
RES3F	80,000
RES4	135,000
RES5	25,000
RES6	25,000
COM1	110,000
COM2	30,000
COM3	10,000
COM4	80,000
COM5	4,100
COM6	55,000

## NATURAL HAZARD MITIGATION SAVES:

Occupancy	Square footage
COM7	7,000
COM8	5,000
COM9	12,000
COM10	145,000
IND1	30,000
IND2	30,000
IND3	45,000
IND4	45,000
IND5	45,000
IND6	30,000
AGR1	30,000
REL1	17,000
GOV1	11,000
GOV2	11,000
EDU1	130,000
EDU2	50,000

**Table 5-12:** Calculating building replacement cost for public-sector riverine flood mitigation.

Structure type	Method
2-4 Family (RES3A)	<ol style="list-style-type: none"> <li>1. Multiply the total square footage in the acquisition by \$113.39.</li> <li>2. Multiple the value in Step 1 by the Hazus regional adjustment factor for the county</li> </ol>
Manufactured home (RES2)	<ol style="list-style-type: none"> <li>1. Multiply the total square footage in the acquisition by \$41.97.</li> <li>2. Multiply the value in Step 1 by the Hazus regional adjustment factor for the county</li> </ol>
Single family (RES1)	<ol style="list-style-type: none"> <li>1. Multiply the total square footage in the acquisition by \$115.20 (Average 1 story average base cost).</li> <li>2. If the value in the FoundationType field of the grant database is 'Basement' multiply the total square footage by \$30.80 (Finished Basement cost). Add this sum to the total from Step 1.</li> <li>3. Multiply the value in Step 2 by the Hazus regional adjustment factor for the county in which the acquisition occurs.</li> </ol>



## NATURAL HAZARD MITIGATION SAVES:

Structure type	Method
	<i>Note: The grant database does not specify the condition, number of stories, or basements, so it was assumed that RES1 structures were in average condition and that that they were 1 story with finished basements.</i>

**Content replacement cost.** Content losses matter. However, the grant database does not include content values. The project team estimated the content replacement cost of RES1, RES2, and RES3A buildings as half the building replacement cost, consistent with the Hazus methodology for estimating content values. Content replacement costs were allocated equally among buildings of the same occupancy class.

**Foundation type, first-floor elevation, and NFIP date of entry.** The project team applied default values from Hazus Release 3.2 for general-building-stock foundation type, first-floor elevation, and NFIP date of entry for the following reasons:

- Foundation type was not populated for many of the grants.
- The grant database did not include information on the date that communities in which acquired structures were located achieved NFIP compliance.
- The field for first floor elevation was sparsely populated in the grant database. In many cases it was reported relative to sea level, not the above-ground height. In addition, there was no way to populate structure specific first floor elevation values in the Hazus GBS inventory.

**Table 5-13:** Hazus square-foot replacement costs.

Occupancy	Hazus Definition	Occupancy Example	RSMeans Cost
RES1	Single-Family Dwelling	Refer to hzRES1ReplCost	
RES2	Manufactured Housing	Manufactured Housing	41.97
RES3A	Multi-Family Dwelling – small	Duplex	113.69
RES3B	Multi-Family Dwelling – small	Triplex/Quads	99.95
RES3C	Multi-Family Dwelling – medium	5-9 units	179.48
RES3D	Multi-Family Dwelling – medium	10-19 units	168.80
RES3E	Multi-Family Dwelling – large	20-49 units	184.58
RES3F	Multi-Family Dwelling – large	50+ units	173.83
RES4	Temporary Lodging	Hotel, medium	189.42
RES5	Institutional Dormitory	Dorm, medium	203.86
RES6	Nursing Home	Nursing home	207.02
COM1	Retail Trade	Dept Store, 1 st	109.60
COM2	Wholesale Trade	Warehouse, medium	106.43
COM3	Personal and Repair Services	Garage, Repair	129.25

## NATURAL HAZARD MITIGATION SAVES:

Occupancy	Hazus Definition	Occupancy Example	RSMean Cost
COM4	Professional/Technical/Business Service	Office, medium	175.24
COM5	Banks	Bank	253.94
COM6	Hospital	Hospital, medium	335.67
COM7	Medical Office/Clinic	Med. Office, medium	241.31
COM8	Entertainment & Recreation	Restaurant	223.98
COM9	Theaters	Movie Theatre	167.98
COM10	Parking	Parking garage	76.21
IND1	Heavy	Factory, small	130.37
IND2	Light	Warehouse, medium	106.43
IND3	Food/Drugs/Chemicals	College Laboratory	206.74
IND4	Metals/Minerals Processing	College Laboratory	206.74
IND5	High Technology	College Laboratory	206.74
IND6	Construction	Warehouse, medium	106.43
REL1	Church	Church	179.35
AGR1	Agriculture	Warehouse, medium	106.43
GOV1	General Services	Town Hall, small	137.50
GOV2	Emergency Response	Police Station	233.80
EDU1	Schools/Libraries	High School	173.88
EDU2	Colleges/Universities	College Classroom	193.62

**Other details of UDF parameters.** A few additional assumptions were required to employ a user-defined-facility inventory:

- A separate UDF database containing individual records for each building was developed for each grant.
- Building-specific occupancy type, replacement cost, square footage, and content cost for each UDF point were derived from the procedures described above.
- The grant database did not report Hazus building type—the material from which structures are constructed. This value must be reported in the UDF inventory. Therefore, RES1, RES2 and RES3A structures were assumed to be constructed with wood.
- The grant database did not report the number of stories for acquired structures. Therefore, RES1, RES2 and RES3A structures were all assumed to be 1 story.
- Missing first floor elevations in the grant database, or first floor elevations reported with respect to sea level as opposed to number of feet above grade, were populated with the pre-FIRM Hazus default for the foundation type specified in the grant database. In other words, it was assumed that these structures

## NATURAL HAZARD MITIGATION SAVES:

had not been elevated as a mitigation measure prior to acquisition. For example, a RES1 building with a foundation type of crawl space received a first-floor elevation value of 3 feet.

- If year built was not provided in the grant database, it was assumed to be 1900. Note that this value is *not* used to determine losses for UDF.
- In a few instances, the latitude and longitude coordinates in the grant database were missing or incomplete (such as instances in which no decimal places were provided). In these situations, the project team estimated location based on street address, if populated. If no street address was available, the point for the building was placed in close proximity to the majority of the other structures acquired under the grant.

### 5.4.2. Riverine Flood Grant Sample

Grants were selected for inclusion in the Interim Study based on the following criteria:

- Must be either a demolition or acquisition project
- Must specify coordinate values for structures acquired by the grant
- Must specify the project amount
- Must only include demolition or acquisition of single family, manufactured home, or 2-4 family structures

Grants from only two programs (HMPG and PDM) met these criteria. These programs represent the majority of flood project dollar amounts. Figure 5-11 shows the location of the counties in the sample.

Table 5-14 presents the number of single-family dwellings (Hanus RES1 occupancy), manufactured homes (RES2) and 2-4-family homes (RES3A) acquired by each sampled grant.



Figure 5-11: Locations of grants selected for the analysis of the effectiveness of flood-prone structure acquisitions.

Table 5-14: Distribution of occupancies within sampled flood grants.

Program	County	Single-family dwellings	Manufactured homes	2-4-family homes
HMPG	Morgan, IN	30	0	0
HMPG	Wagoner, OK	13	0	0
HMPG	Decatur, GA	2	0	0
PDM	DeKalb, GA	8	0	0
HMPG	Polk, WI	1	8	0

### 5.4.3. BCA of Riverine Flood Grants

**Building and content losses.** The project team calculated post-mitigation building and content losses using the default Hazus GBS for each of five MRIs: 10 (10% annual chance), 25 (4% annual chance), 50 (2% annual chance), 100 (1% annual chance), and 500 (0.2% annual chance) years. For each Hazus occupancy type represented in the grant, the project team summed building and content losses over the relevant census blocks. The team limited the census blocks for which values were recorded to those in which acquired structures were located prior to the acquisition.

## NATURAL HAZARD MITIGATION SAVES:

To calculate pre-mitigation conditions, the Interim Study applied a combination of Hazus GBS inventory and Hazus UDF inventory. The UDF inventory was updated to represent the pre-mitigation location and conditions of the structures acquired by each grant. For each grant, the Hazus study region for the first scenario was duplicated to ensure that the same hazard was applied for pre- and post-mitigation. The UDF inventory representing the buildings acquired through the grant was then imported into the duplicated region and the GBS inventory was modified to reflect the mitigated buildings addressed by the grant. Tables specifically modified included those reporting square footage, building count, dollar exposure, and content exposure.

**Direct BI losses.** Hazus analysis was performed for the default GBS in order to estimate post-mitigation conditions for BI losses. The project team calculated and reported BI across all Hazus occupancy types. Hazus calculated BI components included income loss, rental income loss, wage loss, and direct loss. These were summed by full replacement value for the census blocks included in the Interim Study and recorded for calculating the BCR. Census blocks for which values were recorded included only those in which acquired structures were located prior to the acquisition. This step was repeated for each MRI: 10 (10% annual chance), 25 (4% annual chance), 50 (2% annual chance), 100 (1% annual chance), and 500 (0.2% annual chance) years.

To estimate direct and indirect BI loss, the same methodology for post-mitigation analysis was applied to pre-mitigation analysis. This means that the losses were drawn exclusively from the Hazus GBS analysis for both pre- and post-mitigation assessment. To address an error in the calculation of direct economic loss discovered in recent testing of Hazus Release 3.2, the project team multiplied the Hazus income loss, rental income loss, wage loss, and direct loss values by 100.

**Deaths, injuries, PTSD, and sheltering.** To calculate post-mitigation cost of injuries, deaths, and relocation, the project team mapped the Hazus GBS by building count for each occupancy class in the grant. Next, for each census block with an acquired building, the project team visually estimated the percentage of the block that was inundated by the 1% annual chance flood. The project team multiplied that percentage by the total number of buildings for each specific occupancy. For example, if there were 10 single-family dwellings (RES1) in the census block and an estimated 70% of the census block was inundated by the 1% annual chance flood, then 7 RES1 buildings were assumed to be inundated. The project team based this approach on the Hazus assumption that buildings are evenly distributed within a census block. The Interim Study used the dasymetrically adjusted census blocks in Hazus Release 3.2, which have been modified to remove unpopulated areas such as vacant land, forests, water bodies, etc. The resulting census-block boundaries generally cover only populated areas. Thus, the assumption of even distribution of buildings, while not representative of every community, is relatively reasonable.

To calculate instance of death, nonfatal injury, and PTSD, the project team estimated the number of occupants and the number of impacted households as shown in Table 5-15. The project team estimated instances of injuries and PTSD as shown in Equation 5-1 through Equation 5-4. In the equations,  $H$  denotes number of inundated households,  $P$  the total population that experiences at least some flooding, and  $N_i$ ,

## NATURAL HAZARD MITIGATION SAVES:

$N_2$ ,  $N_4$ , and  $N_{PTSD}$  denote the number of instances of Hazus level-1 injury, Hazus level-2 injury, death, and PTSD, respectively. The project team estimated that essentially no Hazus level-3 injuries result from flooding.

To calculate ALE, the project team assumed each household that experiences flooding is out of its home for 360 days. The project team calculated these losses only for flooding with MRIs in excess of 25 years. To determine the pre-mitigation costs related to injuries, deaths, PTSD, and ALE, the project team assumed that all of the acquired structures were in the inundation area and added the number of acquired structures to the number of structures assumed to contribute to social loss in post-mitigation analysis. Acceptable costs to avoid future statistical injuries, deaths, and instances of PTSD are the same as used elsewhere in the Interim Study. Likewise, the costs per day of ALE used here are the same as elsewhere in the Interim Study.

**Table 5-15:** Estimated number of occupants per building for use in estimating benefits of grants to mitigate riverine flooding.

Occupancy	Description	Occupants	Households
RES1	Single-family dwelling	Building count x 2.5	Building count
RES2	Manufactured housing	Building count x 2.5	Building count
RES3A	Duplex	Building count x 5	Building count ÷ 2

$$N_1 = 0.1275 \cdot H$$

Equation 5-1

$$N_2 = 0.04 \cdot H$$

Equation 5-2

$$N_4 = 0.0008 \cdot H$$

Equation 5-3

$$N_{PTSD} = 0.15 \cdot P$$

Equation 5-4

## 5.5. ANALYSIS OF FLOOD RETROFIT MEASURES

### 5.5.1. Analytical Details of Flood Retrofits for Single-Family Dwellings

Prior to analyzing any of the buildings, baseline data was developed for each building. These data consisted of replacement costs for each house type; content value; additional living expenses for occupants displaced from their home; flood insurance premiums; and flood hazard data. Similar datasets were applied across all of the flood mitigation measures. This analysis used sample one- and two-story houses that matched the previous analysis:

- One-story house (1,500 square feet and 3,000 square feet): (a) wood siding - wood frame, (b) brick veneer - wood frame, (c) stucco on wood frame, (d) solid masonry
- Two-story house (2,400 square feet and 4,800 square feet): (a) wood siding - wood frame, (b) brick veneer - wood frame, (c) stucco on wood frame, (d) solid masonry

Data from the National Association of Realtors were compared with other data sources. The project team determined that a split of house types of 58% one-story houses and 42% two-story houses reasonably represent costs and benefits for the mitigation project BCRs.

The building replacement value (BRV), also called replacement cost new (RCN), was calculated for all the one- and two-story construction options using RSMMeans Costworks 2018. This value is applied to building damages for both the acquisition and retrofit elevation project types. Since the analysis did not represent any one specific location, the national average values were used for all calculations. The value of contents in the houses was applied based on the designation from the depth damage function (DDF) associated with the building type (one-story and two-story). Contents values initially were assumed to be 100% of the building replacement cost, since some Hazus DDFs assume this. If the chosen DDF included a specific contents-to-structure value ratio, this ratio was applied to the contents value prior to calculation. Loss of use or displacement values are the other primary value used in the initial calculations. Single-family residential buildings used a simplified approach of 2.5 occupants per building, where each day of displacement from the house would allow for \$77 per house for a hotel room and \$46 per person per day for meals. This methodology is consistent with the current FEMA BCA approach.

To characterize the wide variety of floodplain conditions, the project team developed a series of hypothetical floodplain cross sections using the data from the PELV500 (water depth probability curve) formulas used to designate numbered A zones (A1-A30; see <https://www.fema.gov/flood-zones> for definitions). The PELV 500 formulas have been used as a step in the actuarial methods and assumptions for the flood insurance rating component of the NFIP. The PELV 500 formulas indicate the average difference in depth between floods with 1% and 10% exceedance probability in one year. This depth difference in feet can be used to create an idealized floodplain cross section, assuming a linear relationship between flood depth and the natural logarithm of mean recurrence interval in years. The project team calculated flood hazard for numbered A zones A1-A30, but only used zones A1-A18, since these are the more common floodplains where buildings are constructed. Table 5-16 provides a summary for each

## NATURAL HAZARD MITIGATION SAVES:

numbered A-zone and the difference in flood elevation in feet between the 1% and 10% annual exceedance probability (the so-called 100-year and 10-year flood, respectively). The table also shows an estimate of the fraction of all housing in the floodplain that stands within this numbered A zone. The table also shows, for each zone, the hypothetical flood elevation for each of four annual exceedance probabilities: 10%, 2%, 1%, and 0.2%, for a location in an idealized V-shaped valley whose 100-year flood reaches an elevation of 70 ft.

These hypothetical elevations do not represent any specific location, but are used to provide differences in elevation between each flood event relative to the 100-year flood, so damages can be calculated on the building inventory. While this approach assumes that the cross-valley slope of the floodplain is constant, it allows an analysis of a variety of floodplains to be conducted without needing flood data for every floodplain throughout the United States. The associated weighting factors were used to represent the rounded percentage of buildings within A-zones nationwide. As discussed in the following project specific subsections, the minimum lowest floor elevation was analyzed at the ground elevation for the numbered A zone 10-year flood elevation. Numbered A zone A1 was eliminated from the analysis because the 10-year flood elevation is only 0.5 feet below the 100-year flood elevation. Even homes with a slab on grade in this type of floodplain would be at or above the BFE, so it seemed reasonable to ignore this zone.

**Table 5-16:** Table of hypothetical elevations for idealized floodplains.

Numbered A Zones	Difference between 10-year and 100-year (ft)	Fraction of houses	Hypothetical Elevations for Annual Percent Chance of Flooding			
			10%	2%	1%	0.2%
A1	0.5	1%	69.5	69.85	70	70.35
A2	1.0	1%	69.0	69.70	70	70.70
A3	1.5	1%	68.5	69.55	70	71.05
A4	2.0	3%	68.0	69.40	70	71.40
A5	2.5	6%	67.5	69.25	70	71.75
A6	3.0	8%	67.0	69.10	70	72.10
A7	3.5	10%	66.5	68.95	70	72.45
A8	4.0	11%	66.0	68.80	70	72.80
A9	4.5	11%	65.5	68.65	70	73.15
A10	5.0	11%	65.0	68.49	70	73.49
A11	5.5	10%	64.5	68.34	70	73.84
A12	6.0	9%	64.0	68.19	70	74.19
A13	6.5	7%	63.5	68.04	70	74.54
A14	7.0	6%	63.0	67.89	70	74.89



## NATURAL HAZARD MITIGATION SAVES:

Numbered A Zones	Difference between 10-year and 100-year (ft)	Fraction of houses	Hypothetical Elevations for Annual Percent Chance of Flooding			
			10%	2%	1%	0.2%
A15	7.5	4%	62.5	67.74	70	75.24
A16	8.0	3%	62.0	67.59	70	75.59
A17	8.5	2%	61.5	67.44	70	75.94
A18	9.0	1%	61.0	67.29	70	76.29

The analyses were conducted using a benefit-cost analysis tool similar to FEMA's BCA Toolkit, which calculates annualized losses associated with building damage, content damage, and displacement (also referred to as additional living expenses). These three benefit categories were to the acquisition and retrofit elevation mitigation options. Wet floodproofing and utility retrofit options only considered the equipment (building) damage. Losses were calculated for an existing building condition and then again for a post-mitigation condition. The difference represents the mitigation benefit. The present value of annualized benefits were then calculated as elsewhere in this study, considering the discount rate and the project useful life. These were then compared with the mitigation cost and when applicable any annual maintenance costs also were brought to present value for inclusion in the mitigation cost.

Once a BCA was conducted for all house types in each of the floodplains, the weighting factors shown in Table 5-16 were applied to the BCRs for each building in every flood zone to obtain a national average BCR. Not all of the lowest floor levels below BFE could be considered for every floodplain. In some instances, this might put the lowest floor below the elevation of even the annual stream elevation. To address this, the study assumed that no construction would occur below the 10-year flood elevation. While there is awareness that houses often are constructed at or below the 10-year flood elevation, the lack of location-specific flood data makes it difficult to assume flood data below the 10-year flood. Sections 5.5.2 and 5.5.3 provide tables of the minimum lowest floor elevation data for each numbered A zone and, in some instances, how this criterion also controls the foundation type assumed for the analysis. These weighting factors and lowest floor assumptions address the distribution of floodplains and the distribution or likelihood that houses at various elevations below the BFE would be candidates for mitigation.

The project team lacked empirical data about the lowest floor elevation for houses constructed below the BFE. Elevation certificates often are used by communities to document compliance with their floodplain management policies. These certificates are a primary tool in calculating flood insurance premiums. Insured houses constructed prior to determination of the flood hazard are rated as "pre-FIRM," not based on lowest floor elevation. Consequently, the elevation data for older homes do not exist. As a workaround, the project team assigned the following elevation distribution based on whether houses could be constructed in each floodplain and assumed houses evenly would be distributed across the floodplain.

## NATURAL HAZARD MITIGATION SAVES:

- BFE-1 = 30%
- BFE-2 = 27%
- BFE-3 = 23%
- BFE-4 = 20%

The foregoing breakdown was applied as an initial assumption for all of the mitigation types other than acquisition, where the variation in elevation ranged from BFE-1 to BFE-8. This weighting was applied in conjunction with the weighting outlined in Table 5-16 for each floodplain, A1-A18. When improved weighting values for numbered A zones become available, the benefits and associated BCRs in the study can be updated.

To estimate the reduction in the overhead and profit portion of the flood insurance premium, it was necessary to calculate the premium before and after retrofit. National flood insurance premiums were calculated for each property as a pre-FIRM (non-elevation rated premium) and a post-FIRM elevation rate. The premium benefit only applies to two of the mitigation approaches examined here: acquisition and elevation. For acquisition projects, the project team assumed property owners currently would have a flood insurance policy, move to a location outside of the SFHA, and therefore no longer need flood insurance. With the retrofit elevation, property owners would move from a pre-FIRM policy to a post-FIRM policy that accounts for the elevation. For wet floodproofing and utility retrofit projects, it was assumed that since the property owners currently have a lowest floor below the BFE that they would maintain a Pre-FIRM policy and therefore no change would be applied to these retrofits. While it is possible to do these retrofits on buildings that may be constructed with a lowest floor at or above the BFE, the present study focused on houses below BFE. Flood insurance premium savings were applied for the project useful life, but benefits are limited to the 17% of reduced premiums associated with overhead and profit, since the remaining 83% would double-count the property losses.

### 5.5.2. Analytical Details of Acquisition of Single-Family Dwellings

The analysis examines acquisitions of houses with a lowest floor located at BFE-1, BFE-2, etc., through BFE-8, a range that represents the largest variation in possible lowest floor elevations throughout the present study. The wide range was practical because buyouts do not require the analyst to consider post-mitigation construction challenges. Retrofitting houses to higher elevations, by contrast, presents structural design requirements that complicate the cost estimation.

The acquisition costs were based on data provided by the Federal Housing Finance Agency (FHFA, 2018, 2019). The approximate mortgage cost per house was divided by the average area of a year-round owner-occupied home—approximately 1,800 sf (U.S. Census Bureau 2017)—to estimate a replacement value of \$127 per square foot. This value was adjusted slightly downward to reflect larger area houses. This value may appear low for some areas, but it is intended to represent a national average. The square-foot replacement cost was further adjusted (reduced) to reflect the house being located in a floodplain, and then adjusted back up to the original value to reflect the cost to restore the property to open space.

## NATURAL HAZARD MITIGATION SAVES:

When the project team estimated losses for the benefit-cost analysis, it calculated losses for the pre-mitigation building, and took post-mitigation losses to be zero, since there would no longer be a building there to get damaged. The project useful life was taken to be 100 years, based on the assumption that the land's use as open space would outlast an ordinary building, but conceivably might revert a century later.

Table 5-17 provides an overview of the types of foundations evaluated for the property acquisition benefit-cost analysis. As with other mitigation project types, the foundation type is dictated by whether one can construct it without putting the lowest floor of the building at or above the BFE. A raised first floor foundation (that is, foundation with crawlspace, labeled CS in the table) was excluded where the sum of framing depth (assumed to be 1 foot) plus the height of short (1-foot) piers would result in the lowest floor being at BFE or above, that is, compliant with NFIP requirements. Where less than two feet existed between the lowest floor elevation (BFE-1, BFE-2, etc.) and the 10-year flood elevation, then a slab-on-grade foundation was applied (labeled slab in the table). Where the amount of fill necessary to put the top of a slab-on-grade foundation up to the analyzed lowest floor elevation (BFE-1, BFE-2, etc.) was three feet or greater, the foundation was assumed to be a crawlspace. Where one can build either slab on grade or a crawlspace (labeled both in the table), the total areas of each were taken to be equal. This approach may not necessarily reflect the true distribution of foundations in pre-FIRM houses, but lacking better information, a uniform distribution seemed reasonable.

**Table 5-17:** Table of foundation types assigned to each Numbered A Zone per lowest floor elevation designation

A Zone	A2-A18	A4-A18	A6-A18	A8-A18	A10-A18	A12-A18	A14-A18	A16-A18
	BFE-1	BFE-2	BFE-3	BFE-4	BFE-5	BFE-6	BFE-7	BFE-8
A2	Slab							
A3	Slab							
A4	Slab	Slab						
A5	Slab	Slab						
A6	Both	Slab	Slab					
A7	Both	Slab	Slab					
A8	CS	Both	Slab	Slab				
A9	CS	Both	Slab	Slab				
A10	CS	CS	Both	Slab	Slab			
A11	CS	CS	Both	Slab	Slab			
A12	CS	CS	CS	Both	Slab	Slab		
A13	CS	CS	CS	Both	Slab	Slab		
A14	CS	CS	CS	CS	Both	Slab	Slab	

## NATURAL HAZARD MITIGATION SAVES:

A Zone	A2-A18	A4-A18	A6-A18	A8-A18	A10-A18	A12-A18	A14-A18	A16-A18
	BFE-1	BFE-2	BFE-3	BFE-4	BFE-5	BFE-6	BFE-7	BFE-8
A15	CS	CS	CS	CS	Both	Slab	Slab	
A16	CS	CS	CS	CS	CS	Both	Slab	Slab
A17	CS	CS	CS	CS	CS	Both	Slab	Slab
A18	CS	CS	CS	CS	CS	CS	Both	Slab

Depth-damage functions were selected to be consistent with other modules of this study, and generally reflect Hazus default selections. The project team modeled single-story houses with slab foundation using the depth-damage functions labeled USACE – New Orleans: one-story slab foundation for freshwater short duration flooding. Similarly, for single-story houses with crawlspaces, the project team used the analogous depth-damage functions for pier foundations. See Figure 5-12.

Depth-damage functions for two-story single-family houses (Figure 5-13) were represented with the USACE – New Orleans: two-story slab foundation curves for freshwater short duration flooding and the USACE – New Orleans: two-story pier foundation curves for freshwater short duration flooding. These curves are labeled “New Orleans” because they were developed by the New Orleans District of the USACE, not because they solely represent houses in New Orleans. The New Orleans District curves were selected because the available curves represented both pier and slab foundations, long and short-duration flooding, and freshwater and saltwater options. Because the present study focused on riverine flooding, the freshwater flooding curves were used rather than saltwater. Short duration was selected to err on the side of lower rather than higher losses, and therefore lower rather than higher benefits.

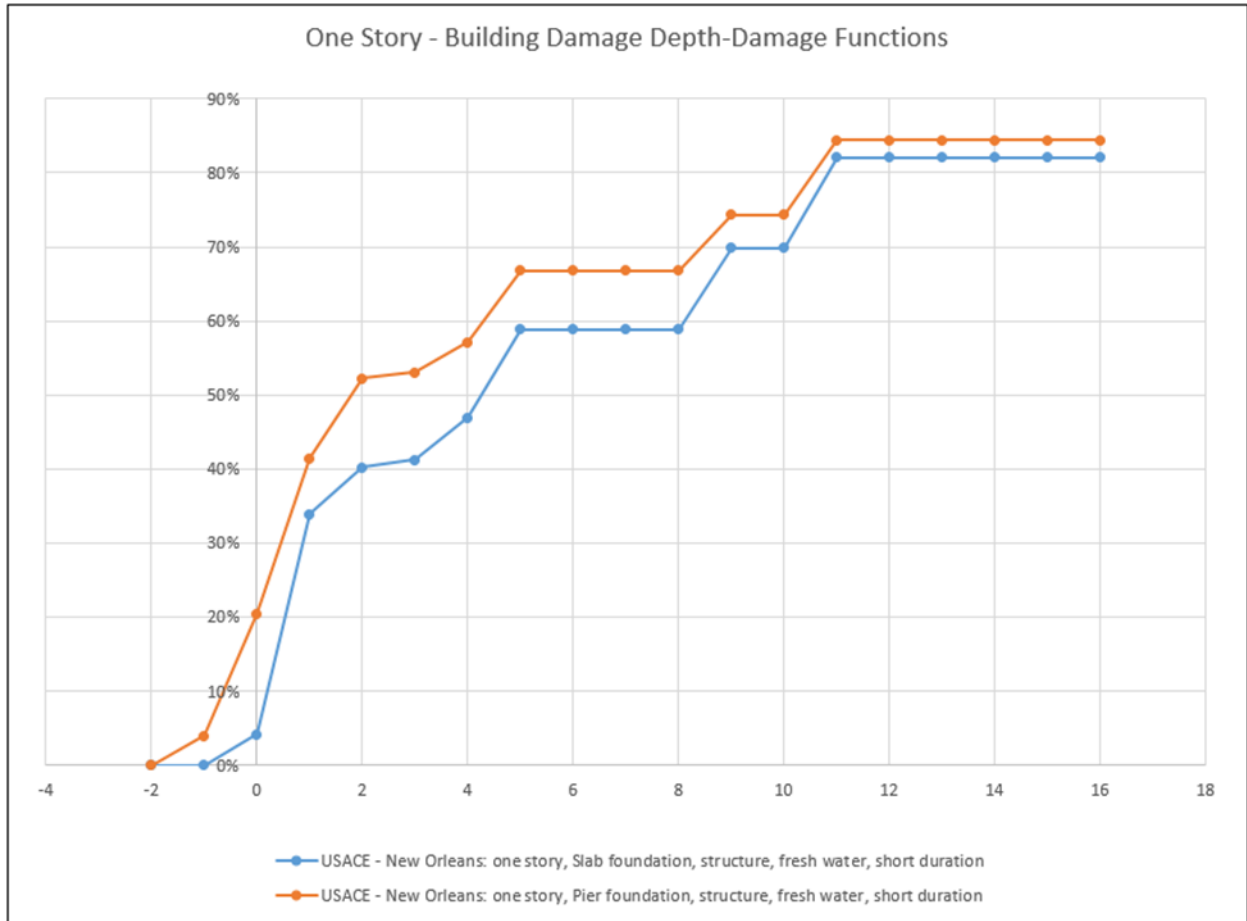

Figure 5-12: Depth-damage functions for one-story houses.

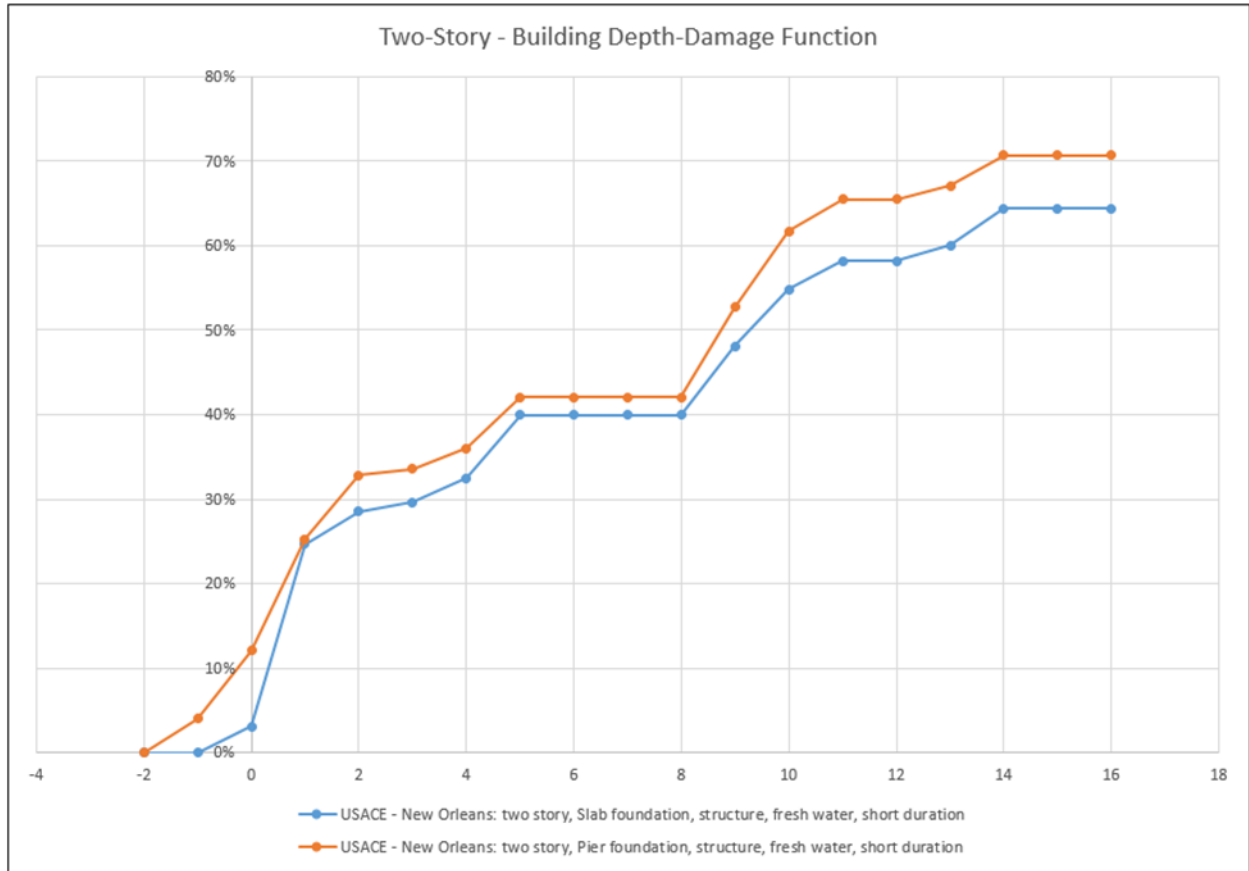

Figure 5-13: Depth-damage functions for two-story houses.

An initial benefit-cost analysis was conducted for all the houses and combinations of foundation type, lowest floor elevation, and numbered A zone. The avoided costs and benefits for each combination losses were weighted as shown in Table 5-16. The average value for building repair cost, contents loss, additional living expenses, and retrofit costs then were averaged for each building type based on floor area, lowest floor elevation, and relative quantities of one-story and two-story houses. Indirect business interruption was taken as 47% of additional living expenses as elsewhere in this study, and losses associated with PTSD were added, using the expedient of 3.5% of the value of building damages, which is equivalent to the analysis based on the number of displaced households as calculated in an earlier part of the study.

Acquisitions are the only flood retrofit considered here to include reduction of deaths. A large percentage of flood deaths occur from people traveling through floodwaters either on foot or in a car. It was therefore assumed that once a property is acquired, the occupants (2.5 people per household) no longer need to travel through the floodwater to or from their house. This used the FEMA value of human life using the FAA value of a statistical fatality avoided (2015) = \$9.6 million adjusted to reflect to chance of someone dying as the yearly average nationwide flood deaths (86 people) divided by the US population.

## NATURAL HAZARD MITIGATION SAVES:

Environmental benefits also were included in the acquisition benefits. U.S. Census data indicated that the average lot size for a single-family house is approximately 0.25 acres. This value was then applied using FEMA's green space value of \$7,853 per acre of green space and applied on a per-property basis.

Based solely on the foregoing considerations, acquisitions provide a benefit-cost ratio of approximately 2.0 using a 2.2% discount rate and 0.7 using a 7% discount rate. This result was inconsistent with historic studies of acquisition grants conducted by FEMA and other agencies. The primary reason is that people do not do acquisition projects unless they are cost effective. That is, the foregoing does not screen out projects that have a benefit-cost ratio below 1.0.

Two factors impact whether a property has sufficient vulnerability to have avoided damages for it to be cost effective. Although these two factors generally are tied together, they could be considered independently. First, the lowest floor elevation must be sufficiently low. A house at BFE-2 is more likely to have sufficient vulnerability than one constructed to BFE-1. Additionally, the house must be located in a floodplain, where the damage will accumulate sufficiently to raise the annualized damage high enough that it is cost effective. A house with a lowest floor elevation of BFE-1 in numbered A zone A2 will have a higher probability of floodwaters reaching the first floor than a house that has a lowest floor of BFE-1 in zone A18. These combined factors mean that the same properties will become less and less cost effective as you move into higher numbered A zones from A2 toward A18.

Communities with properties with a variety of lowest floor elevations would sort the non-cost-effective properties out before requesting a grant FEMA does allow the use of aggregation where cost-effective and non-cost-effective property benefits can be combined to allow a group of homes in an area to be acquired as long as the overall BCR is above 1.0. Since the study was hypothetical in nature, it was hard to sort properties in such a way to result in an overall BCR of 1.0. The assumption for the study was to evaluate acquisitions on a per-property, cost-effectiveness basis rather than aggregate all possible houses in the floodplain. Federal agencies make up a large portion of property acquisition grants and use the 7% discount rate per OMB Circulars A-4 and A-94. It was therefore decided to sort the properties based on their being cost effective at a 7% discount rate. The resultant BCR would be more representative of the effectiveness of acquisition mitigation grants and more consistent with past studies. No other sorting adjustments were made. The resultant BCRs are recapped in Table 5-18.

**Table 5-18:** Summary of acquisition BCRs by discount rate.

Discount rate	BCR
2.2%	6.2
3.0%	4.8
7.0%	2.2

### 5.5.3. Analytical Details of Retrofit Elevation of Single-Family Dwellings

Retrofit elevation represents one of the most common flood retrofits and is the most effective mitigation measure that still leaves the building in its original location within the SFHA. This analysis evaluates the cost effectiveness of elevating single-family houses to a post-retrofit lowest floor elevation of BFE+1. This approach is consistent with requirements in many municipalities and government agencies that provide grants and require compliance with ASCE 24. Elevations often are conducted with money associated with grants, but also are done using private money. The present study evaluated undamaged, pre-FIRM houses between BFE-1 and BFE-4, as discussed in Section 4.6.1.4.

As described in Section 4.6.1.4, there are two different methods to elevate houses that depend on foundation type. Table 5-19 outlines the assumptions made for the foundation types for each numbered A zone and existing lowest floor elevation.

**Table 5-19:** Foundation types evaluated for retrofit elevation analysis. Slab = Slab-on-grade and CS = Crawlspace.

Zone	A2-A18	A4-A18	A6-A18	A8-A18
	BFE-1	BFE-2	BFE-3	BFE-4
A2	Slab	N/A	N/A	N/A
A3	Slab	N/A	N/A	N/A
A4	Slab	Slab	N/A	N/A
A5	Slab	Slab	N/A	N/A
A6	Both	Slab	Slab	N/A
A7	Both	Slab	Slab	N/A
A8	CS	Both	Slab	Slab
A9	CS	Both	Slab	Slab
A10	CS	CS	Both	Slab
A11	CS	CS	Both	Slab
A12	CS	CS	CS	Both
A13	CS	CS	CS	Both
A14	CS	CS	CS	CS
A15	CS	CS	CS	CS
A16	CS	CS	CS	CS
A17	CS	CS	CS	CS
A18	CS	CS	CS	CS



## NATURAL HAZARD MITIGATION SAVES:

The project team estimated retrofit cost using RSMeans Costworks 2018 based on the building footprint, height of the foundation above ground before and after retrofit, number of required flood openings, and whether the existing building had a brick veneer. Project costs averaged approximately \$65-75 per square foot for crawlspace foundations and approximately \$101 per square foot for slab-on-grade foundations.

The costs to elevate a slab-on-grade house were similar, regardless of whether one separates the walls and roof from the slab and builds a new floor system, or lifts the slabs still attached to the wall systems. Because the two costs were similar, it was unnecessary to judge the relative frequency of the two conditions, which was fortunate because the project team was unaware of any empirical information on which to base the relative frequency. As previously discussed, the costs only were calculated for buildings from BFE-1 through BFE-4 to a final elevation of BFE+1. Readers should assume that costs for elevation will increase as additional elevation is considered. Important variables that could increase the retrofit cost include increased requirements for size or amount of reinforcing, footing sizes, or wall and pier thickness.

Retrofit elevation differs from acquisition in that after the mitigation is completed, there still is residual flood vulnerability. That is, the retrofitted house could still experience flooding. In areas where the floodplain is better represented by a numbered A zone closer to A2, elevating a structure to BFE+1 could put the lowest floor elevation at the elevation of the 1,000-year flood. However, in areas where the floodplain is better represented by a numbered A zone closer to A18, then BFE+1 equates to a 129-year flood when the flood elevation would reach the top of the lowest floor. Residual damages are minimal closer to a numbered A zone A2, and the flood vulnerability after retrofit elevation increases as floodplain conditions reach something similar to an A18. This is based on the probability of floodwaters reaching the lowest floor elevation being much more likely as conditions move closer to an A18.

The project team used the same depth-damage functions for elevations as it did for acquisitions. Damages post retrofit elevation were calculated using no further adjustments to slab-on-grade foundations. A sensitivity analysis was done for the crawlspace foundation to eliminate any damages less than one foot below the floor system or the bottom of the floor joists. Most depth-damage functions begin at two feet below the lowest floor, but this change did not result in any significant changes to the estimated losses. This is likely because the percent damage is so low for this portion of the depth-damage function and because of the low flood probability in the post-retrofit condition.

The elevation retrofit does not avoid fatalities or provide environmental benefits in the form of open space, so no such benefits were calculated here. Occupants still live within the floodplain so they are still likely to consider traveling through floodwaters, which is the main cause of flooding deaths, as opposed to drowning within one's home. Insurance benefits were calculated as described in Section 5.5.1.

Similar to the sorting approach applied to acquisition projects, a comparison was conducted between the raw elevation data and sorting based on projects being cost effective using a discount rate. Before filtering for non-cost-effective properties, the average BCR was approximately 1.4 using a 2.2% discount rate, but 0.8 with a 7% discount rate, which as before was inconsistent with historic studies of elevation grants conducted by FEMA and other agencies. Again, people do not undertake retrofit elevation projects unless

## NATURAL HAZARD MITIGATION SAVES:

they are cost effective. The same factors outlined in Section 5.5.2 also apply to retrofit elevation. Retrofit elevation does however differ from acquisition in that elevation projects are a mixture of grant-funded elevations and owner-financed elevations. Since there is a mixture of both funding sources, the project team decided that the 7% discount rate would artificially inflate the BCR since it would remove several houses from consideration that private owners might decide to retrofit since their financial decisions can be made with discount rates other than the 7% rate. The project team decided that using the 3% discount rate would be a more appropriate sorting rate. When using the 3% discount rate, there were very few BFE-1 existing lowest floor conditions that were cost effective and the team decided this was an unlikely condition for retrofit elevation. Adjustments were made to the benefits and costs to only consider BFE-2 through BFE-4. Existing houses at BFE-2 are more likely to be owner-financed projects, while houses at BFE-3, BFE-4 or lower are more likely candidates for grants. The following breakdown was used for the retrofit elevation analysis:

- BFE-2: 10%
- BFE-3: 40%
- BFE-4: 50%

These adjustments to the values resulted in the BCRs shown in Table 5-20. Higher BCRs could be achieved if further adjustments were made to the percent breakdown of houses and more weight was placed on BFE-4 houses. While the cost of elevation is lower than that of acquisition, there is residual risk following a retrofit elevation. Additionally, two benefit categories for casualty and open space were not considered and flood insurance premiums were reduced, but not eliminated. The final adjustment that results in the difference in BCRs between retrofit elevation and acquisition is the project useful life used for evaluation. The analysis assumed that elevations only are performed on pre-FIRM buildings. This means that houses would have been constructed in large part 35 years ago or more. This study broadly assumes that residential buildings will have an expected lifespan of approximately 75 years. Evaluating this constraint, the project team chose to use a 30-year project useful life, which often is used for evaluating elevation projects. Moving this value up to a 40-year project useful life results in a BCR of 2.3 at a 2.2% discount rate.

**Table 5-20:** BCRs for flood elevation retrofit for each of three discount rates.

Discount Rate	BCR
2.2%	1.9
3.0%	1.7
7.0%	1.1

### 5.5.4. Analytical Details of Wet Floodproofing Basements of Single-Family Dwellings

This project and the utility retrofits described in Section 5.5.5 could be combined into one project to provide more comprehensive mitigation below the lowest floor elevation. The mitigation options were divided into multiple analyses to allow the largest number of readers to consider the options since groupings may have eliminated consideration if all the criteria do not apply to a specific situation.

The project team used RSMeans Costworks 2018 to estimate the cost of wet floodproofing. One must replace common wall coverings with more flood resistant materials, add flood openings, and eliminate or elevate basement-level electrical systems. The estimated cost to wet floodproof an 8-foot high basement area was \$15.49 per square foot of basement footprint. These costs generally agree with FEMA P-259, *Engineering Principles and Practices of Retrofitting Flood Prone Residential Structures (3<sup>rd</sup> Edition)* (Federal Emergency Management Agency 2012e) inflated to 2018.

The project team used RSMeans Costworks 2018 to estimate building replacement costs for basement areas. These costs were developed to isolate the damage associated with a basement area, since the intent of this analysis was to look only at the value of wet floodproofing a basement. A new depth-damage function was created for this purpose. All damages are in reference to the lowest floor elevation. The assumption was that water would start to enter through a basement window at approximately 3 feet below the lowest floor elevation (lowest floor elevation minus 1 foot for floor framing and a 2-foot high window) and then increase to the lowest floor elevation. The following depth-damage function refers to flood depth relative to the finished floor elevation (FFE), meaning the top of the lowest floor FFE-3 = 75% damage, i.e., repair costs 75% of the replacement cost of the basement.

- FFE-2 = 88% damage
- FFE-1 = 100% damage
- FFE = 100% damage

Cleaning a flooded basement that has been wet floodproofed should be minimal and primarily cosmetic, not requiring costly replacement of any items in the basement. The primary effort will be removal of any water, but this issue would be similar whether the basement was wet floodproofed or not. The analysis primarily focused on avoiding physical damage to the basement area. Readers may decide that additional benefits could be accounted for by wet floodproofing a basement area, and this modification would increase the cost effectiveness of such measures.

Assumptions regarding the number of buildings at each lowest floor elevation were maintained at the baseline values for both the wet floodproofing and utility mitigation retrofit measures. This is because there was insufficient data to indicate a change was appropriate. The following breakdown was used based on the initial assumptions of the possible houses at each lowest floor elevation:

- BFE-1 = 30%, i.e., 30% of wet floodproofed houses have lowest floor elevation at BFE-1

## NATURAL HAZARD MITIGATION SAVES:

- BFE-2 = 27%
- BFE-3 = 23%
- BFE-4 = 20%

The project useful life for this mitigation option was taken to be 20 years to reflect the fact that many basement areas periodically are renovated by homeowners because of the moisture and dampness inherent in basement areas and particularly in floodplains. Even without floodwaters reaching the basement area, the material lifespan is shorter. Since the majority of these retrofits would be financed by homeowners rather than grants, it was decided to evaluate the cost effectiveness using the 2.2% discount rate. The resultant BCRs are shown in Table 5-21. A longer project useful life would produce higher BCRs. There is sufficient room in the BCR that even a 30% increase in the cost results in a BCR of 1.9 at a 2.2% discount rate, a BCR of 1.8 at 3% discount rate, and a BCR of 1.3 at a 7% discount rate.

**Table 5-21:** BCR for wet floodproofing existing houses, by discount rate.

Discount rate	BCR
2.2%	2.4
3.0%	2.2
7.0%	1.6

### 5.5.5. Analytical Details of Utility Retrofits of Single-Family Dwellings

For simplicity, the study combined the analysis of retrofitting air conditioning units or heat pumps with ductwork. Ductwork would be mitigated by placing it in the attic area of a single-floor house. On a two-story house, one would add furring around the duct trunk line on the soffit of the second floor. The air handler could be placed in a first-story closet, as described in FEMA P-348, *Protecting Building Utility Systems from Flood Damage* (Federal Emergency Management Agency 2017d) Section 4.1.2.2. Air conditioning units and heat pumps often can be elevated on platforms or in some instances on cantilevered platforms. Furnaces and water heaters often can be relocated to attic areas. Tankless water heaters present another option for relocating water heaters above the first floor, but this option has a higher initial cost and more uncertain maintenance costs. The present analysis considers the pre- and post-retrofitted house to have a standard tank water heater. Homeowners should work with professional heating and plumbing contractors to understand all the necessary requirements and potential costs when evaluating a project.

The project team estimated the cost to relocate ductwork from basement or crawlspace areas and to elevate an air conditioning unit or heat pump to be approximately \$5.03 per square foot, most of which (approximately 80%) pays to relocate ductwork. It costs approximately \$6.42 per square foot to retrofit a furnace above the lowest floor elevation. To relocate a water heater costs about \$6,000, which includes relocating the unit to an attic and perform all the plumbing and flue system adjustments that would not have been part of the original house construction.

## NATURAL HAZARD MITIGATION SAVES:

The project team used RSMeans Costworks 2018 to estimate equipment replacement values and compared them with other readily available heating and plumbing construction information. These costs were developed to isolate the damage associated with just the equipment being evaluated and does not consider other damages to the house. A new set of depth-damage functions were created for the analysis to represent the flood risk to this type of equipment located in a basement area or crawlspace. All damages are in reference to the finished floor elevation (FFE), also called lowest floor elevation. The analysis assumes that once floodwaters touch the equipment, it completely would be damaged and would need to be replaced. For the ductwork and air conditioning unit or heat pump, it was assumed this equipment would be approximately two feet below the FFE. This assumes a floor system depth of approximately one foot and an additional foot for the height of the ductwork. The analysis assumed that a furnace or water heater would be approximately three feet below the FFE in a crawlspace, and would require replacement if touched by floodwater. As with the analysis of wet floodproofing, it was assumed that water would enter the basement at three feet below the FFE.

The project useful life generally would be at least as long, possibly longer, than the normal life of a water heater (about 10 years), because replacements would be placed in the same location as the elevated equipment. The project team assumed the following useful lives:

- Air conditioning unit or heat pump: 15 years
- Ductwork: 30 years
- Furnace: 30 years
- Water heater: 30 years

Similar to the wet floodproofing analysis, it was assumed that since these projects would not make the houses compliant with current floodplain management ordinances that these would be homeowner-financed retrofits. It was therefore determined to use a 2.2% discount rate. BCRs are shown in Table 5-22 for elevating an air conditioner or heat pump and the associated relocation of ductwork. Table 5-23 presents BCRs for relocating a furnace or water heater.

**Table 5-22:** BCRs to relocate air conditioners or heat pumps and their associated ductwork, by discount rate.

Air conditioning unit/heat pump elevation and ductwork relocation	
Discount rate	BCR
2.2%	1.53
3.0%	1.41
7.0%	1.00

**Table 5-23:** BCRs to relocate furnaces and water heaters, by discount rate.

Furnace and water heater relocation	
Discount rate	BCR
2.2%	2.21
3.0%	2.00
7.0%	1.30

### 5.5.6. Analytical Details of Summarizing the Overall Single-Family Dwellings

The foregoing sections detail the benefit-cost analyses of five flood retrofit measures, with per-house costs and BCRs. To estimate benefits, costs, and BCR at a societal level requires an estimate of the number of houses receiving each kind of retrofit. The project team estimated the fraction of houses that would receive each kind of retrofit based on an evaluation of grants for the state of Ohio, and considering how likely the project team thought people likely were to seek a grant versus personally financing the retrofit. The final adjustments were made to address the desire to remove as many existing properties below the BFE as possible from the floodplain. Although this analysis includes several benefit categories, it is recognized that additional unquantified benefits exist for homeowners who are removed from the floodplain (peace of mind, heirlooms, pets, etc.). The project team estimated total societal benefits and costs based on the following distribution of mitigation efforts, assuming that most retrofit efforts would use only one strategy:

- Acquisition: 60%
- Retrofit elevation: 20%
- Wet floodproofing of basements: 10%
- Air conditioning/heat pump and ductwork: 5%
- Furnace and water heater: 5%

Weighting the foregoing costs and benefits by this distribution results in the total nationwide benefit-cost ratios shown in Table 5-24.

**Table 5-24:** Estimated nationwide BCR of flood retrofits, by discount rate.

Discount Rate	BCR
2.2%	5.3
3.0%	4.2
7.0%	2.0

But how many houses in total might be retrofitted? An initial study was conducted to determine whether it was possible to calculate the total number of single-family homes in the SFHA constructed prior to flood maps being available for their location. FEMA’s policy data were evaluated for the 50 states and District of Columbia to determine an approximate number of NFIP insurance policies. This number resulted in

approximately 4,935,425 policies. Using this number, two alternatives were explored to see if the resultant number appeared to be reasonable for calculating the number of houses that could be exposed based on this study's parameters.

Alternative 1 found a Wharton Business School Report that indicated 95% of flood insurance policies are residential (Kousky 2017). This paper also stated that approximately 68% of those policies were for single-family homes, suggesting 3,188,285 single-family dwellings are covered by an NFIP policy. A Congressional Budget Office Report indicated that 44% of NFIP policies were zone A policies (Congressional Budget Office 2017), which would further reduce the number to 1,402,845. While this number would include houses subject to coastal flooding, there was no clear way to sort out the different zone A flood risk.

How many of these single-family dwellings were built prior to adoption of flood maps, say before about 1985? U.S. Census Bureau data suggests that 60.5% of existing homes were built before 1985 (U.S. Census Bureau 2013). This further reduced the number to 848,721 properties. The Wharton report (Kousky 2017) suggests that only 50% of people eligible for flood insurance carry it, which doubles the candidate population to 1,694,637 houses.

Alternative 2 used the same baseline number of NFIP policies of 4,935,425. A Congressional Budget Office Report indicated that out of flood insurance policies, 16% are zone A with subsidized rates (Congressional Budget Office 2017). This adjusts the value to 789,668 buildings. The Wharton report (Kousky 2017) says that 95% are residential and 68% of those are for single-family dwellings. This results in an estimated 510,126 single family dwellings with pre-FIRM zone-A policies. Again, assuming 50% market penetration suggests 1,020,251 candidates for the retrofits considered here.

The project team believed that the total number of single-family homes constructed in locations prior to flood mapping being available is likely higher than one million houses. FEMA's hazard mitigation assistance statistics indicate that for 30 years, approximately \$15 million has been spent on mitigation. Since the present analysis indicates that flood mitigation is cost effective, the figure of \$15 million suggests that relatively few houses out of all those that could be cost-effectively retrofitted have actually been retrofitted. One could say that a substantial investment gap exists between what has been spent and what cost effectively has been spent.

The estimated range of 1.0 million to 1.6 million pre-FIRM houses does provide some insight into how many single-family houses may be at risk within the floodplain. Recall, however, the elevation-related boundary conditions identified during the scoping of the study that indicate that these numbers do not represent *all* the buildings within the SFHA that were constructed prior to the adoption of flood maps. The study team did, however, feel that understanding the total number of single-family houses that met this condition might better inform the total number of buildings used to calculate the overall BCR.

Until someone can more definitively estimate the number of candidate houses that could be cost-effectively retrofitted, it seems reasonable to pursue a third option: Use a round number that if anything

underestimates the total number, but allows easy factoring when the number of structures can be determined. For simplicity then, a value of 1 million single-family dwellings was used for the study. That is not to say that there actually *are* 1 million pre-FIRM single-family dwellings that could cost-effectively be retrofitted, although that figure essentially is within the bounds estimated here, albeit at the low end.

The only further adjustment identified in the analysis was likely that the average single-family house used for the study may be larger than the average single-family house constructed below the BFE. The average single-family home evaluated in the study is 2,817 square feet as compared with 1,800 square feet. This is 156% of the size of the average home, based on data from the U.S. Census Bureau (2017).

Since most of the benefits and costs calculated here were based on square-foot values, this difference does not change the overall calculated BCR. However, it might influence the total dollars of avoided damage for flood retrofits if better data become available on the total number of single-family houses in the SFHA with lowest floor elevations below BFE. As indicated previously, though the number of houses used for the study is a lower-bound estimate, it is likely that even factoring this number by 156% would still be below the number of houses at risk.

## 5.6. DESIGNING TO EXCEED I-CODE REQUIREMENTS FOR HURRICANE SURGE

A common approach to increase the elevation of a coastal dwelling is to raise the building on wooden piles. The project team used construction cost estimates that appear in Appendix E of FEMA P-550 (Federal Emergency Management Agency 2009d). Costs were developed in 2006 for the first edition of FEMA 550 and provide rough order-of-magnitude estimates for both labor and material for three scenarios: elevated 0 to 5 feet above grade, elevated 6 to 10 feet above grade, and elevated 11 to 15 feet above grade. These costs were updated to 2017 prices using the Consumer Price Index (CPI) Inflation Calculator and returned estimates of approximately \$1,150 per foot of elevation. Wooden stairs add approximately \$300 per foot of elevation (RSMMeans C2010 110 1150), for a total of approximately \$1450 per foot of elevation. Some houses have wheelchair ramps. How many, and at what cost? Examination of 682 sample houses in 5 coastal cities listed in vrbo.com suggests that approximately 5% are wheelchair accessible. (Miami, Florida: 6 of 101 are wheelchair accessible = 6%; Biloxi, Mississippi: 6 of 26 = 23%; Galveston, Texas: 18 of 459 = 4%; Charleston, South Carolina: 1 of 54 = 2%; Tampa, Florida 5 of 42 = 12%; total 36 of 682 = 5%).

These data imply that on the order of 5% of new homes with greater elevation would also have wheelchair ramps. The 5% figure coincidentally agrees with HUD requirements that 5% of federally funded new homes in developments must comply with requirements of the ADA, and must therefore have wheelchair ramps. Realistically, the figure could rise in coming decades as the American population ages. An informal survey of online estimates of the cost of permanent wheelchair ramps suggests costs range widely, from \$1,000 to \$3,000 per foot of elevation. (Sources: North Carolina State University College of Design, Center for Universal Design 2004, Networx 2011, ProMatcher 2017, Angie's List 2013). The project team adds 0.05



## NATURAL HAZARD MITIGATION SAVES:

× \$2000 = \$100 per foot of elevation for wheelchair ramps, accounting for the fact that only some new houses will be built with wheelchair ramps. With nominal additional costs for utility risers and additional exterior closure material for ground-level storage space, the total cost is therefore approximately \$1,550 per foot of elevation.

### 5.7. GRANTS FOR WIND MITIGATION

Stratified sampling of mitigation projects by hazard level yielded a total of 48 projects: 19 low-hazard, 14 medium-hazard, and 15 high-hazard. The project team could not use several of the records selected at random for sampling, typically for the following reasons:

1. **Insufficient data.** The database did not contain enough information to determine exactly what mitigation had taken place, and the project team could not find sufficient supplementary information from the internet or the state hazard mitigation officer.
2. **Not actually mitigation.** Many grants that appeared at first glance to be about mitigation turned out in fact to reflect mostly or entirely post-event rebuilding.
3. Not about mitigating buildings. The mitigation was part of a distributed utility or transportation lifelines such as electrical power or roads. A separate part of the present project focuses on utilities and transportation lifelines.
4. **Public services.** The mitigated properties were essential facilities, such as hospitals or fire stations, where quantifying life savings outside of the mitigated facility was beyond the scope of this project.

To select 15 valid samples by hazard level required several iterations of sampling. After the initial sampling, several projects appeared to have very high or very low BCRs. The mitigation of two vulnerable buildings that house high-value equipment resulted in BCRs exceeding 50. Two community restrooms in recreation areas that were also intended to serve as tornado shelters did not appear well suited for use solely as tornado shelters. Perhaps they had been hardened because visitors would have no other viable alternative in the event of a tornado. Their BCRs approached zero. But this is speculation. The project team could not determine details of these projects sufficiently to be confident of the estimated BCR, so the project team excluded these results. Ultimately the project team analyzed fewer than its intended 15 projects per hazard level. Of the mitigation efforts selected, 14 addressed hurricane hazards and 34 dealt with tornadoes. There were few building mitigation projects in medium- and low-hazard regions. The low- and medium-hazard projects primarily protected life safety with tornado safe rooms and shelters. There were no hurricane projects selected in low-hazard locations.

### 5.8. ADOPTING I-CODE REQUIREMENTS FOR HURRICANE

#### 5.8.1. Building Inventory for Below-Code Design for Wind

To estimate the costs and benefits of adopting modern code requirements, the project team evaluated annualized losses and present value of losses as if the building stock built in 2019 were built two different

## NATURAL HAZARD MITIGATION SAVES:

ways: to comply with 2018 I-Codes and to comply with construction prior to Hurricane Andrew, using 1992 as a baseline year. The buildings for each decade are assumed to be designed to conform to the performance based and prescriptive requirements of the time. This includes the increased roof loading and building envelope protection requirements stated in each version of the code. The quantity of buildings built in 2019 is estimated as 1% of the current inventory, using the rule of thumb that the United States adds about 1% to its building stock annually.

### 5.8.2. Cost of Complying with 2018 I-Codes for Wind

To characterize the additional construction costs attributable to increased code requirements between pre-Hurricane Andrew and current (2018) I-Codes, the project team estimated a baseline pre-Hurricane Andrew construction cost as well as the cost to satisfy the equivalent of a current IBHS FORTIFIED Commercial Bronze designation. The project used scaling factors derived from current 2018 I-Code and Commercial Bronze, incorporating the difference in design wind pressures described in Section 3.3.1. These factors were applied to the 2018 I-Code to establish an estimate of pre-Hurricane Andrew construction by design wind pressure. The costs reflect stricter requirements for protecting the building envelope and higher roof loading. IBHS provided estimates of the costs to comply with the IBHS FORTIFIED Commercial Bronze, Silver, and Gold designations.

## 5.9. PRIVATE-SECTOR HURRICANE WIND RETROFIT MEASURES

### 5.9.1. Analytical Details of Hurricane Wind Retrofit Regarding IBHS FORTIFIED Home

Table 5-25 summarizes the effect of various discount rates for the IBHS FORTIFIED Home program. The analysis shows when the discount rate from the real cost of borrowing is increased to 7%, the BCR is nearly reduced by half. Both benefits and costs change. Benefits go down with higher discount rates because the present value of future avoided losses decreases. Costs also go down because at higher discount rates, the optimal FORTIFIED designation changes from Gold to Silver in very high wind regions (150 mph to 170 mph ASCE 7-16 regions).

**Table 5-25:** Sensitivity of BCR to discount rate for IBHS FORTIFIED Home Retrofit

Discount rate	2.2%	3%	7%
Benefit, \$ million	\$141,000	\$115,000	\$54,000
Cost, \$ million	\$24,000	\$24,000	\$19,000
BCR	6	5	3

Table 5-26 summarizes how the expected life of the building affects the calculated benefit-cost ratio for the IBHS FORTIFIED Home program. The table shows that BCR varies nearly linearly with effective life of

## NATURAL HAZARD MITIGATION SAVES:

the mitigation, and the optimal FORTIFIED designation does not change at all, within this reasonable band of expected life.

**Table 5-26:** Sensitivity of BCR to effective life for IBHS FORTIFIED Home Retrofit.

Effective life, years	50	75	100
Benefit, \$ million	\$116,000	\$141,000	\$155,000
Cost, \$ million	\$24,000	\$24,000	\$24,000
BCR	5	6	7

### 5.9.2. Analytical Details of Hurricane Wind Retrofit for Manufactured Housing

Table 5-27 summarizes the effect of discount rate on the number of manufactured housing units for which an engineered tie-down system is cost effective (having benefit-cost ratio greater than 1.0), along with total dollar benefits, total dollar costs, and BCR. As expected, increasing the discount rate modestly reduces both the quantity of housing units for which the retrofit is cost effective and BCR.

**Table 5-27:** Sensitivity of BCR to discount rate for engineered tie-down systems.

Discount rate	2.2%	3%	7%
Housing units with cost-effective retrofit, \$ million	0.13	0.12	0.10
Benefit, \$ million	\$772	\$691	\$432
Cost, \$ million	\$194	\$184	\$154
BCR	4	4	3

The useful life of an ETS is uncertain, varying with the degree to which the environment accelerates corrosion of the steel straps, connectors, and anchors. Along the Gulf and Atlantic coasts, an ETS might last anywhere from 10 years to 30 years, possibly more. Table 5-28 summarizes how the effective life of the mitigation affects the overall BCR. The results show that an ETS installation still can be cost effective even if the effective life is only 10 years rather than 30 years, although to a smaller total number of housing units (100,000 units rather than 130,000 units).

**Table 5-28:** Sensitivity of BCR to design life for engineered tie-down systems.

Effective life, years	10	20	30
Housing units with cost-effective retrofit, \$ million	0.10	0.12	0.13
Benefit, \$ million	\$315	\$526	\$772
Cost, \$ million	\$164	\$197	\$194
BCR	2	3	4

## NATURAL HAZARD MITIGATION SAVES:

The installed costs of an ETS appears to be dropping over time and varies depending on demand, model, and location. Table 5-29 summarizes how the cost of retrofit influences the overall benefit-cost ratio. The analysis assumed a baseline cost of \$1,500, but also estimated benefits and costs for \$1,000 and \$2,000 per installation. The number of cost-effective housing units changes by 20,000 when the cost goes up or down by \$500.

**Table 5-29:** Sensitivity of BCR to retrofit cost for engineered tie-down systems.

Retrofit cost	\$1,000	\$1,500	\$2,000
Housing units with cost-effective retrofit, \$ million	0.15	0.13	0.11
Benefit, \$ million	\$745	\$772	\$700
Cost, \$ million	\$148	\$194	\$220
BCR	5	4	3

Pre-1976 manufactured homes have significant weaknesses in the superstructure (the part of the house above the frame under the floor) that act like weak links in a chain, weaknesses that an ETS does not address. An ETS provides less benefit to these older homes. How does including them in the analysis change the results? Table 5-30 answers that question. It shows the number of housing units for which an ETS is cost effective, along with benefit, costs, and benefit-cost ratio, under three different conditions: (1) considering all manufactured homes in the hurricane-prone regions of the Gulf and Atlantic coasts; (2) considering only those built after 1976 (and the advent of HUD's Manufactured Home Construction and Safety Standards); and (3) considering only the most modern manufactured homes, after the standards included wind zones. Considering fewer homes in the first place (only 37% of housing units postdate 1994) greatly reduces the number for which an engineered tie-down system is cost effective, from 130,000 (under case 2) to 50,000, although the benefit-cost ratio goes up (from 4 to 5). Including pre-1976 manufactured homes has a modest effect, increasing the number of manufactured homes for which an ETS has a benefit-cost ratio greater than 1.0 from 130,000 to 150,000, and no significant change in overall benefit-cost ratio.

**Table 5-30:** Sensitivity of BCR to the inclusion of different eras of construction.

Era of construction	All	1976+	1994+
Housing units with cost-effective retrofit, \$ million	0.15	0.13	0.05
Benefit, \$ million	\$870	\$772	\$953
Cost, \$ million	\$233	\$194	\$210
BCR	4	4	5

The benefit-cost analyses presented here consider the avoided losses from future disasters, considering how severe and frequently each occurs. Sometimes it can be interesting to study the savings if one performed a mitigation measure just before a particular disaster occurred. There can be places where the

## NATURAL HAZARD MITIGATION SAVES:

benefit-cost ratio is less than 1.0 when one accounts for the rate at which various disasters occur, but greater than 1.0 if one assumes a particular disaster occurs.

The engineered tie-down system provides a useful illustration. In seven counties of the Florida panhandle, the ETS has a benefit-cost ratio less than 1.0; see Section 2.6.2.2. But those counties do experience large, rare disasters. Hurricane Michael caused widespread damage there. It produced wind speeds much higher than the ASCE 7-16 design wind speed, reaching winds with a 1,700-year mean recurrence interval, that is, winds with 0.06% probability of occurring in any given year. Their probability is nearly zero, but they actually occurred. What would have been the savings if owners of unanchored manufactured homes had invested in an ETS before Michael struck?

The project team estimated the reduction in loss divided by the cost of the ETS for 18 counties in the Florida panhandle given the occurrence either of (1) ASCE 7-16 design wind speeds (which have a mean recurrence interval of 700 years, or slightly over 0.1% probability in any given year), and (2) ASCE 7-16 1,700-year wind speeds (0.06% per year), about what some places experienced in Michael. In both cases, installing ETS on all unanchored manufactured homes saves more than it costs. Given the 700-year winds, the ETS saves \$2.40 per \$1.00 of installation cost. Given the 1,700-year winds, the ETS saves \$3.70 per \$1.00 of installation cost and produces a total benefit of \$19 million in the 18 counties. One could perhaps call that ratio a scenario benefit-cost ratio. See Figure 5-14 for maps of the scenario benefit-cost ratios for (A) 700-year wind speeds and (B) 1,700-year wind speeds.

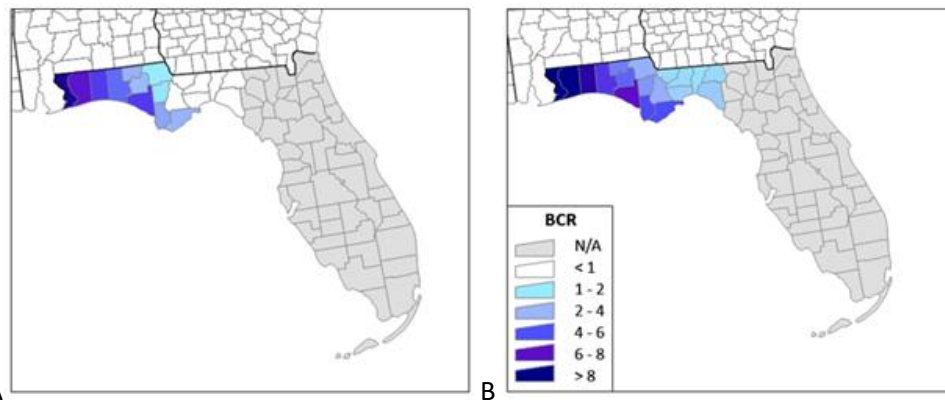

Figure 5-14: Scenario benefit-cost ratios of installing ETS on unanchored manufactured homes in the Florida panhandle, given (A) 700-year wind speeds and (B) 1,700-year wind speeds.

## 5.10. ADOPTING I-CODE REQUIREMENTS FOR EARTHQUAKE

### 5.10.1. Building Inventory for Below-Code Design for Earthquake

To estimate the costs and benefits of adopting modern code requirements, the project team evaluated annualized losses and present value of losses as if the building stock built in 2019 were built two different ways: to comply with 2018 I-Codes, and to the same, except with strength and stiffness multiplied by

factors of 0.67, 0.44, and 0.30, to approximate strength and stiffness requirements of 30, 60, and 90 years ago. The quantity of buildings built in 2019 is estimated as 1% of the current inventory, using the rule of thumb that the United States adds about 1% to its building stock annually.

### 5.10.2. Cost of Complying with 2018 I-Codes for Earthquake

Construction cost is taken as increasing by 1% for a 50% increase in strength and stiffness, as detailed in Porter (2016a), and as detailed in Section 5.11.1. The same proportions are assumed to apply to a weaker, more flexible building relative to current code:

$$\hat{c} = 0.02 \times \left( \frac{C'_s - C_s}{C_s} \right)$$

Equation 5-5

Where  $\hat{c}$  refers to the fractional change in construction cost of any new building,  $C'_s$  refers to design base shear under what-if conditions (whether weaker or stronger than current code), and  $C_s$  refers to design base shear under current code. Thus, the cost to comply with 2018 I-Code requirements for strength and stiffness, relative to a building that is 67% as strong as required under current code, is estimated to be 0.7% of current cost.

### 5.10.3. Benefit of Complying with 2018 I-Codes for Earthquake

Table 5-31 shows BCRs relative to the three eras and the incremental increase in costs and benefits as the strength and stiffness of new buildings is increased from 0.30 to 0.44 to 0.67 to 1.0 times current requirements. The table shows the ratio of the incremental benefit to the incremental cost, as well as the incremental savings of lives and nonfatal injuries. Figure 5-15 plots the incremental benefits against incremental costs.

**Table 5-31:** Long-term benefits of adopting modern seismic design requirements.

Strength & stiffness as a factor of current	Approximately equivalent era	$\Delta$ Cost, \$ billions	$\Delta$ Benefit, \$ billions	$\Delta$ B/ $\Delta$ C	$\Delta$ lives saved	$\Delta$ nonfatal injuries avoided
0.30	1928	0	0			
0.44	1958	0.3	17.0	57	30	47,000
0.67	1988	0.4	15.9	40	27	43,000
1.00	2018	0.6	7.1	12	15	22,000

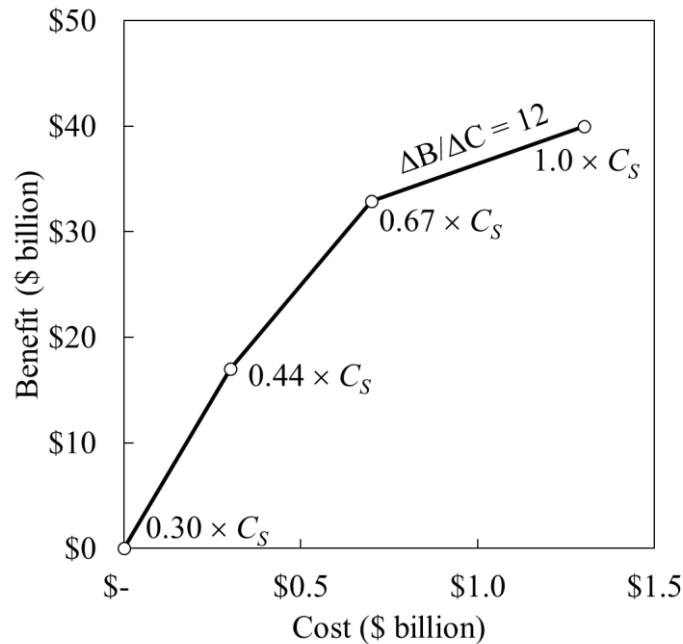

Figure 5-15: Incremental costs and benefits of seismic design provisions.

## 5.11. DESIGNING TO EXCEED I-CODE REQUIREMENTS FOR EARTHQUAKE

### 5.11.1. Cost to Build New Buildings to Exceed I-Code Requirements for Earthquake

This section largely quotes Porter (2016a). There are several reasons why designing to exceed 2015 I-Code requirements for earthquake, as conceived here, may not drastically increase construction costs. Informal discussions with four California engineers suggest that designing to  $I_e = 1.5$  would increase construction costs on the order of 1 to 3% (D. Bonneville, verbal communication, January 2015; E. Reis, verbal communication, April 2014; J. Harris, verbal communication, August 2015; R. Mayes, verbal communication, January 2015). A fifth source is given by the National Institute of Standards and Technology (NIST) Grant/Contract Report (GCR) 14-917-26 (NEHRP Consultants Joint Venture, 2013), in which the authors found that redesigning six particular buildings in Memphis, TN, to comply with the 2012 IBC rather than the 1999 SBC, would increase their strength on average by 60%, and would increase their construction cost between 0.0 and 1.0%.

A sixth source of support can be found in Olshansky et al. (1998), who estimated a similar marginal cost to increase from no seismic design to code minimum. It is further supported by the estimated cost to achieve an immediate occupancy performance level rather than life safety for one of the index buildings of the CUREE-Caltech Woodframe Project (Porter et al. 2006). In California, the marginal construction cost

increase of 1 to 3% would translate to a much smaller marginal development cost increase, since land can constitute more than half the value of a building, and land value is unaffected by  $I_e$ .

An eighth argument can be seen in the fact that costs do not differ dramatically between locations with dramatically different design strengths. One could build five architecturally identical buildings in (A) Sacramento, California, (B) San Diego, California, (C) eastern San Francisco, and (D) western San Francisco, and find that they have site-class-adjusted, short-period, risk-targeted  $MCE_R$  shaking values (denoted  $S_{MS}$  in ASCE/SEI 7-10) of 0.8g, 1.2g, 1.5g, and 2.3g, respectively. Pluck the life-safe building at (D) out of the ground and place it 10 km east at (C) and it will satisfy design for  $I_e = 1.5$ . Place it 800 km south at (B) and it would nearly satisfy  $I_e = 2.0$ , or a mere 140 km northeast at (A) to satisfy  $I_e = 3.0$ . If it were unaffordable to build buildings 50% stronger than life safety, there would be no new construction in San Francisco, and all new development would take place 140 km away in Sacramento.

Some people might not believe such low marginal costs are realistic. How can such a strength increase not produce a similar cost increase? Consult a square-foot cost manual such as RSMMeans (2015) and one will find that approximately 67% of construction cost of a new office building is spent on the architectural, mechanical, electrical, and plumbing elements (Figure 5-16), approximately 17% on O&P, and of the remaining 16% structural cost, approximately half is spent on labor. Most of the final 8% (mostly structural material) is spent on the gravity-resisting system: the foundation, floor slabs, and gravity-resisting columns and beams. Of the small remaining portion that is spent on materials for the earthquake load-resisting system (perhaps as much as 2%), consider that strength does not increase linearly with quantity of material, but can increase with the square or a higher power of material. For example, a W44x230 wide-flange steel shape is about 63% stronger than a W30x191 shape but weighs (and therefore costs) only about 20% more. In that particular case, strength increases with cost to the power of 2.6 (e.g.,  $1.2^{2.6} = 1.63$ ). More-extreme cases can be cited.

A ninth argument can be seen in Weber (1985), who found that to adopt the developing seismic provisions of the time would add between 0.9% and 2.1% to construction costs of the day, with the lower figure being more applicable where seismic design was already in practice. Weber did not offer an estimate of changes in strength or stiffness involved, but the small incremental change of that day does agree with the one suggested here on an order-of-magnitude basis.

In light of these observations, it seems reasonable to estimate that  $I_e = 1.5$  produces a 1% increase in construction cost, on average, overall, and that other values increase cost in proportion. The project team does not assert that the cost of every building increases in such a simple, linear way. Some increments of design strength for some buildings would require changes in foundation design that could dramatically increase construction cost. On the other hand, some buildings might increase in construction cost at a lower rate relative to  $I_e$  because of their inherent strength. As with other aspects of the Interim Study, these costs are estimated overall averages, not uniform truths that apply to every single building.



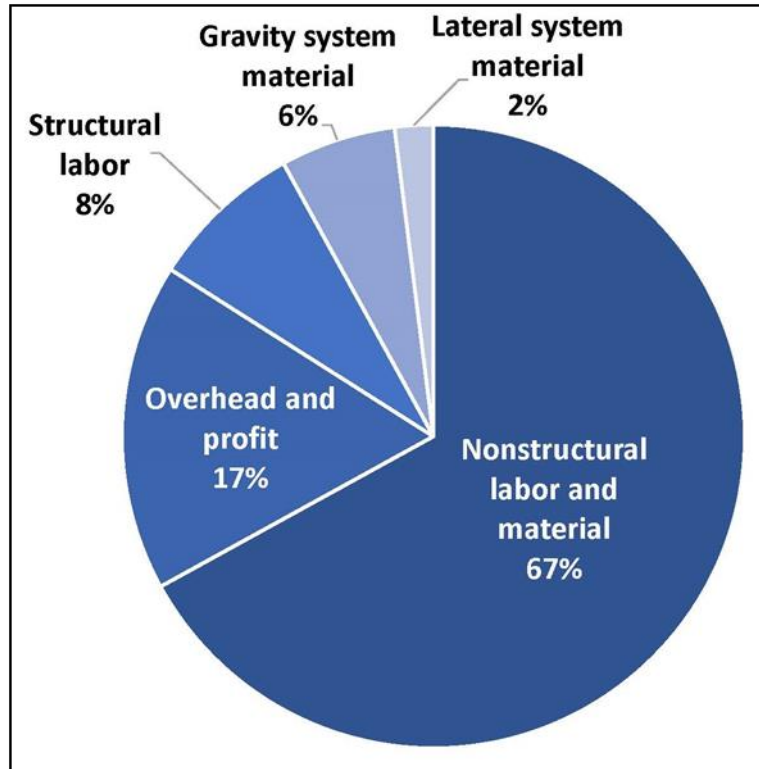

Figure 5-16: Proportional cost of new office building construction and impact on construction costs associated with increasing lateral strength.

### 5.11.2. Vulnerability of Buildings that Exceed I-Code Requirements for Earthquake

Hazus does not offer tabulated vulnerability functions for buildings, but rather creates them as needed for internal use only. They cannot be used outside of Hazus, which means they cannot be used in conjunction with modern seismic hazard information. Because the project team committed to using modern seismic hazard information, using Hazus directly (or the Hazus Advanced Engineering Building Module or FEMA BCA Tool) is not an option for evaluating seismic risk to buildings in the present project.

Furthermore, the Hazus seismic vulnerability functions reflect a single value of strength and stiffness for each of its four code levels and each of three special design levels. These are generally consistent with design of the 1990s, when Hazus was developed and prior to the advent of design for site-specific seismic hazard (albeit inconsistent even with then-current near-fault design modifiers in the final UBC). Since the 2000 and 2003 editions of the IBC, engineers have designed buildings with minimum lateral strength that varies from location to location—even a few kilometers can make a 50% difference in design strength, and a 2-times difference over distances as small as 150 km. Thus, to use a single vulnerability function for a particular high-code model building type can introduce gross, and unnecessary, errors in building capacity and therefore risk. This is unnecessary because it is practical to create seismic vulnerability functions that are consistent with modern design, considering design for site-specific seismic hazard.

## NATURAL HAZARD MITIGATION SAVES:

How can one create the required vulnerability functions for classes of buildings that exceed 2015 I-Code requirements? For reasons discussed in Chapter 4, FEMA P-58 would be ideal for individual buildings, and FEMA P-58 in combination with the Global Earthquake Model (GEM) analytical methodology (Federal Emergency Management Agency 2012d, Porter et al. 2014) would be ideal for building classes. They can handle structural and nonstructural damage, repair costs, life-safety impacts, and repair time. These tools have not yet been automated to the point where they can practically address the approximately 700,000 combinations of lateral force resisting system (28 non-obsolete model building types), height range (3 ranges), occupancy class (28 occupancy classes), MCER shaking (31 levels), and degree of extra strength and stiffness (10  $I_e$  levels), required for the present analysis.

Porter (2009a, b) offers a more approximate but readily automated method to create tabular vulnerability functions entirely consistent with Hazus. By changing particular model parameters (especially the seismic response coefficient  $C_s$  of ASCE/SEI 7), one can create vulnerability functions that are consistent with designing for site-specific seismic hazard both for code-level and for designing to exceed I-Code requirements. For example, one can reflect the vulnerability differently of buildings in which design strength  $C_s = 0.4g$  in northwestern Tennessee than similar buildings in which  $C_s = 0.3g$  in western San Francisco,  $C_s = 0.2g$  in eastern San Francisco,  $C_s = 0.13g$  in San Diego or Sacramento, etc. One can reflect the vulnerability of designing to exceed I-Code requirements with a 1.5 seismic importance factor for a location with code-level  $C_s = 0.2g$  using, for example, a vulnerability function for  $C_s = 0.3g$ . The greater stiffness required for designing to exceed I-Code requirements can be similarly reflected through a smaller value of elastic period  $T_e$ .

Advantages and disadvantages of the three approaches are summarized in Table 5 17. The project team selected option 2. See Appendix K for details of the analytical methodology. See Box 4-2 for more discussion.

**Table 5-32:** Options for seismic vulnerability of buildings.

Option	Pros	Cons
1. Porter (2009a,b) high-code vulnerability functions	Simple; already published	Inconsistent with design for site-specific seismic hazard since at least 2000, e.g., ASCE 7-10 $S_{DS}$ and $S_{D1}$ , & therefore likely grossly inaccurate. Uses 1990s-era pushover approximations of structural response.
2. Create new high-code vulnerability functions reflecting design for site-specific hazard using Porter (2009a, b) methodology but with $A_y$ and $D_y$ reflecting	Consistent with design for site-specific seismic hazard that has been common since 2000. ASCE 7-10 $S_{DS}$ and $S_{D1}$ , more accurate	More effort. Uses 1990s-era pushover approximations of structural response.

site-specific ASCE 7-10 $S_{DS}$ and $S_{D1}$		
3. Create new vulnerability functions using FEMA P-58 and the GEM component-based analytical vulnerability methodology (Porter et al. 2014).	Uses modern 2nd-generation performance-based earthquake engineering methods (like FEMA P-58) to reflect structural response, rigorous statistical surveys of building populations to quantify building diversity, and moment matching to propagate uncertainty. Most accurate.	No such category-based vulnerability functions for all U.S. building types have been created. Considering the 700,000 vulnerability functions required and the lack of automation to create them, this option seems impractical for the present project.

## 5.12. GRANTS FOR EARTHQUAKE MITIGATION

**Supplementing available data.** As in the *2005 Mitigation Saves* study, the electronic data provide only a subset of the information required for a BCA. They do not include all of the grant application data that the grantee submitted on paper. Where the original electronic data contain precise addresses, participating agencies provided only approximate geolocation in order to protect personally identifiable information. They provided latitude and longitude to no more than 3 decimal places (approximately 100 meters) and no street number (e.g., at most street name). Many records in the database provide years in which the buildings were built, but none contain information about building type either before or after mitigation, beyond a description of the use to which the building is put, such as single-family dwelling. None provide the year in which the work was performed. Few include detailed descriptions of the work performed.

To satisfy its data needs, the project team reached out to some grantees to request additional information, but mostly acquired the necessary data via web searches. A great deal of information of many projects is available online in the form of scholarly journal articles, trade journal articles, news articles, press releases, and the web pages of companies that performed the work. These items provided many of the details of the mitigation effort and the year in which the mitigation was undertaken. In cases where the project team was unable to acquire sufficient data online about a project, it resampled, substituting a different project from the same value stratum. The project team repeated the process of resampling until sufficient data were found for a project for each of the 25 strata.

The project team determined precise geographic locations for all sampled grants (generally to 4 or more decimal places, about 10m or less), estimated building area, number of stories, and model building types using Google Earth and Google Earth Street View.

## NATURAL HAZARD MITIGATION SAVES:

One can estimate site soil classification for each building (an important variable for site hazard) using the USGS OpenSHA site data application tool, which draws on maps of site class by Wills and Clahan (2006) and Wald and Allen (2007).<sup>26</sup>

**Characteristics of sampled projects.** The project team sampled 23 high-hazard projects. The target was 25, but two very large projects crossed four strata: 1) seismic retrofit of electrical substations in the Los Angeles Department of Public Works and 2) replacement of pendant light fixtures in the Los Angeles Unified School District. Together, these two projects represented approximately 15% of the total project amount. Figure 5-17 shows sample project locations. There were no projects in medium- or low-hazard regions, just as in the *2005 Mitigation Saves* study. Other high-hazard grants include:

- Hospitals in San Francisco, Santa Ana, Norwalk, and Duarte, California; and, Olympia, WA.
- University classroom and administration buildings in Berkeley and San Bernardino, California.
- Civic centers in Pasadena, Berkeley, Huntington Beach, Santa Monica, and El Centro, California.
- Miscellaneous other public buildings such as a Seattle, WA, church and a city parking structure.

Of the 23 sampled projects, 18 deal with structural retrofit of existing buildings. The remainder deal with bracing ceilings in two hospital buildings and a county office building and replacing pendant light fixtures in schools. Of the 23 sampled projects, two are located in Washington, one in Oregon, and one in Utah. The remainder are located in California.

**Methodology.** To estimate most benefits, the project team used FEMA's BCA Tool, Version 5.3.0. Data requirements vary between different kinds of projects, but generally involved:

- Building location (address, latitude, and longitude)
- Project cost
- NEHRP site soil class (A, B, C, D, E, or F)
- Total building area
- Number of stories
- Total building replacement cost (new)
- Time-average number of occupants (averaging over time of day and day of week)
- Year of construction
- Building height
- Historical value
- Occupancy classification
- Code level, using FEMA's pre-code, low-code, moderate-code, high-code classification scheme (Federal Emergency Management Agency 2012). Pre-code, for example, refers to a building that was

---

<sup>26</sup> Both those authorities have developed newer maps of site class, but neither has been implemented in OpenSHA. The incremental increase in accuracy might be significant for new design or possibly even single-site risk analysis, but probably does not matter in a portfolio risk analysis such as this study, where errors will tend to cancel out.

## NATURAL HAZARD MITIGATION SAVES:

designed and built without significant seismic design requirements, while high code refers generally to modern seismic design requirements, especially in high-seismicity areas.

- In some cases, other details such as: public service that the building provides (fire department, hospital, government service, etc.); population served; additional travel time to a similar nearby facility if this one is rendered inoperative; and annual budget.
- The user can optionally vary detailed engineering characteristics, such as elastic period of vibration, deformation at which complete structural damage occurs, etc.

One enters the required data in a wizard-style user interface and then calculates EALs before and after mitigation using the standard method presented in Chapter 4: integrate hazard (the negative first derivative of exceedance rate of each of several levels of excitation) and vulnerability (the loss conditioned on excitation, as a fraction of value exposed) and multiply by value exposed. It estimates annualized losses in dollar equivalent terms, in each of seven categories: structural repair costs, two categories of nonstructural repair costs, acceptable costs to avoid statistical deaths and injuries, relocation costs, and two categories of losses associated with direct BI. It calculates the present value of losses before and after mitigation and the BCR.

The BCA Tool estimates direct BI losses but not indirect BI, so the project team applied the same method to the study of federal mitigation grants as for the study of exceeding building codes, estimating indirect BI as a factor  $Q$  of the cost of direct BI. See Appendix K, Section 0 for details.

The BCA Tool does not estimate loss of historic value or environmental damage. While several of the buildings in the earthquake sample are of historical value, the project team generally could not apply the method developed in the *2005 Mitigation Saves* study to estimate the loss of historical value associated with damage, mostly because that method requires an estimate of the annual number of visitors to the facility. However, judging from the 2005 study, the loss of historic value is probably very small compared with other losses that are estimated here.



Figure 5-17: Locations of sample high-hazard earthquake mitigation projects.

**Sample project data development.** This section examines one project so that the reader can understand the methods used to fill in details that are missing from the grant database. Consider, for example, one building from a project to retrofit fire stations in Gresham, Oregon. FEMA data from PDM grant PDMC-PJ-10-OR-2009-003 indicates that Station 74 was located somewhere on NE 192nd Avenue near 45.533N, -122.466W, and was built in 1966. Using Google Earth and Google Earth Street View, the project team identified the street address as 1520 NE 192nd Avenue, Gresham, Oregon 97230, at coordinates 45.5340N, -122.4658E; see Figure 5-18 for satellite and street views. With Google Earth, the project team estimated the building's plan area as approximately 4,700 sf. Based on street views and familiarity with common construction practices, one can estimate that the building resists lateral forces with reinforced masonry shearwalls and a flexible roof diaphragm (RM1 in FEMA terminology). According to the newspaper *DJC Oregon*, the project mitigated deficient roof-to-wall connections, a common problem with older RM1 buildings.

One can estimate the replacement cost (new) of the building using an RSMeans *Square Foot Costs Book*, which provides a nationwide average per-square-foot cost for similar fire stations of \$170 per square foot (2012 USD). RSMeans provides a location cost factor (accounting for local variations in construction cost) of 1.0. One can account for increases in construction costs between 2012 and 2016 using a deflator calculated as the ratio of national GDP PPP in 2016 to that in 2012. GDP data were acquired from the World Bank. The deflator suggests current costs 12% higher than in 2012. One can add another 100% of the building value to account for content value, including firefighting apparatus, which leads to an estimated replacement cost (new) of \$380 per square foot, including contents and apparatus.

## NATURAL HAZARD MITIGATION SAVES:

One can assign a pre-code Hazus design level to the pre-retrofit building in light of its 1966 year of construction and its location in Oregon. One can assign a post-retrofit design level of moderate code. The term “pre-code” suggests construction before seismic design provisions were adopted, at least for the subject building. The term “moderate code” means that the retrofit strengthens the new building, though probably not enough to satisfy requirements of the most recent building codes, since the project description speaks of modifications to the roof and roof-to-wall connections, but not of changes to wall reinforcement.

The total project amount was \$617,000, which one can divide between the two buildings of this project in proportion to their plan area. Station 74 was estimated to have cost \$353,000 to retrofit, or about \$75 per square foot, which seems sufficient to strengthen the roof diaphragm and to connect the roof to the walls. The project team estimated average occupancy to be 10 people at all hours. A web search suggested that the station serves approximately 27,500 people (4 total stations serving a total population of 110,000 residents of Gresham, Oregon). If the station were rendered inoperative, apparatus from a nearby station would have to travel approximately 7.5 additional miles to serve buildings that would otherwise be served by Station 74.

The project team estimated the present value of benefits for Gresham fire stations to be \$3.9 million, mostly from reduced loss of service to the community in the event of an earthquake, and with small contributions from reduced property loss (about 1.2%) and reduced deaths and nonfatal injuries inside the stations (about 0.7%). The estimated BCR for this one project is 6.4.



Figure 5-18: Gresham Fire Station 74 (A) in Google Earth Street View, and (B) from above.

## 5.13. PRIVATE-SECTOR SEISMIC RETROFIT MEASURES

### 5.13.1. Analytical Details of Seismic Retrofit for Soft-Story Wood-Frame Multifamily Dwellings

Drawing on the observations by Vukazich et al. (2006) and ATC-38 (Applied Technology Council, 2000), discussed in Chapter 3, the project team estimated that on average, 25% of the estimated square footage

and building replacement cost of existing wood-frame multifamily dwellings (in FEMA terminology, W1 or W2 buildings with RES3 occupancy class) have soft-story conditions and potentially would benefit from this retrofit measure. The project team estimated that the average resident of such a building might occupy the ground story for perhaps 10 minutes a day, dealing with mail, parking, accessing storage space, or doing hobbies.

Table 5-33 summarizes the effect of discount rate on the number of housing units for which soft-story retrofit is cost effective, total dollar benefits, total dollar costs, and BCR. The table shows that discount rate does not strongly affect the nationwide average BCR for retrofit, where the mitigation measure is cost effective, although the discount rate does reduce the number of places where mitigation is cost effective. Increasing the discount rate from the real cost of borrowing to 7% reduces by half the quantity of dwellings for which the retrofit is cost effective. Note BCR does not decrease monotonically with increased discount rate because of the change in the number of places where mitigation is cost effective. Increasing the discount rate removes locations with the lowest BCR values.

**Table 5-33:** Sensitivity of BCR to discount rate for soft-story retrofit.

Discount rate	2.2%	3%	7%
Housing units with cost-effective retrofit, million	1.4	0.9	0.7
Benefit, \$ million	\$190,000	\$150,000	\$71,000
Cost, \$ million	\$16,000	\$11,000	\$7,600
BCR	12	14	9

### 5.13.2. Analytical Details of Seismic Retrofit for Manufactured Housing

Table 5-34 summarizes the effect of discount rate on the number of manufactured housing units for which engineered tie-downs are cost effective, along with total dollar benefits, total dollar costs, and BCR. As with soft-story retrofit, increasing the discount rate reduces the quantity of housing units for which the retrofit is cost effective, but it does not strongly affect BCR. Outcomes of this retrofit are less sensitive to discount rate than soft-story retrofit because of the shorter design life of an engineered tie-down: Its baseline design life is 30 years versus 75 years for soft-story retrofit.

Table 5-35 summarizes how the effective life of the mitigation affects BCR: Increasing the effective life increases the number of manufactured housing units for which the mitigation is cost effective and increases the overall BCR.



**Table 5-34:** Sensitivity of BCR to discount rate for engineered tie-down systems.

Discount rate	2.2%	3%	7%
Housing units with cost-effective retrofit, million	0.14	0.13	0.11
Benefit, \$ million	\$690	\$620	\$410
Cost, \$ million	\$210	\$200	\$160
BCR	3	3	3

**Table 5-35:** Sensitivity of BCR to design life for engineered tie-down systems.

Effective life, years	15	30	60
Housing units with cost-effective retrofit, million	0.10	0.14	0.17
Benefit, \$ million	\$340	\$690	\$1,200
Cost, \$ million	\$140	\$210	\$250
BCR	2	3	5

### 5.13.3. Analytical Details of Securing Residential Furnishings, Fixtures, Equipment, and Contents

Table 5-36 shows how discount rate affects the benefit-cost ratio of securing residential furnishings, fixtures, equipment, and contents. Discount rate does not strongly affect the nationwide average BCR, largely because the effective life of four of the five measures is short: 10 years for hot water heaters and nine years for the remaining measures other than kitchen cabinet latches. The shorter the effective life, the less discounting affects the present value of future savings.

Only one of the measures, strapping hot water heaters to the building frame, involves a highly uncertain parameter: a factor to reflect how fire following earthquake is highly nonlinear with earthquake size. Figure 5-19 depicts the tornado-diagram analysis of how sensitive BCR is to that parameter, labeled “cat factor” in the figure, along with effective life of the mitigation measure and discount rate. The figure shows that the mitigation measure is cost effective over the range of reasonable values for this parameter.

**Table 5-36:** Sensitivity of BCR to discount rate for residential retrofit measures.

Element	Discount rate		
	2.2%	3%	7%
Water heater	24	23	22
Kitchen cabinet latches	8	7	4
Bookcases, shelving, and display cases	13	13	13
Desktop electronics (computers, monitors, stereos, etc.), smooth surface	5	5	5
Fragile objects on shelves or in display cases	3	3	3

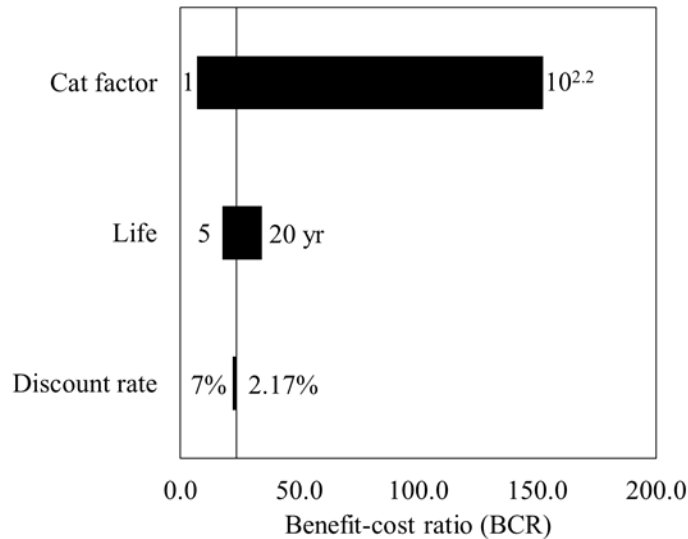

Figure 5-19: Tornado diagram for BCR of strapping water heaters to the building frame.

## 5.14. GRANTS FOR FIRE AT THE WUI

The database contains a total of 756 individual properties in a total of 114 grants. Two projects, both for retrofitting of private structures in Cook County, Minnesota, numbered 338 properties (45% of total), while representing only about 14% of the total cost. A sample of the database was extracted, first by hazard level (high, medium, and low) and then by 4% slices of total stratum cost, resulting in 75 samples. Of these, 28 contained sufficient information on which to base an estimate of project BCR. All but one of the projects had useful information on the internet. The project team telephoned or emailed subgrantees for 21 of the 28 grants to obtain additional information. Several of the projects involved a relatively few structures. These included:

- Replacement of several older wood tanks with steel tanks in Calaveras County (California) Water District. The grant was for \$1,160,000. The project team assumed maintenance would add \$10,000 per year for the life of the project. The tanks serve an estimated 713 households with a population of 1,476. The FEMA BCA Tool (version 4.5.5, no longer available) estimated a project BCR of 2.5. The benefit derives from avoiding the loss of revenue from 20% of customers for an extended period following wildfires where MRI varies between 6 and 40 years. It also assumes the BCA Tool's internal discount rate of 7%. This benefit is based on the (unstated) assumption that the wood tanks are flammable, while the new steel tanks are not vulnerable to fire if supplied with a defensible space. The benefit estimate, however, excludes the improved water supply to the customers, which would provide firefighting water supply for at least some houses. Assuming improved water supply is available to half the 20% of customers, the project team estimated an added benefit of \$14 million using FEMA's BCA Tool (version 5.3) using the same 7% discount rate. That is, the addition reflects protecting 70 houses and the associated occupant death and injury, as well as the loss of revenue. In the *Report*, the discount rate is taken as

## NATURAL HAZARD MITIGATION SAVES:

approximately 2.2% rather than 7%, which resulted in a final estimated benefit of almost \$32 million, resulting in a BCR of 24. (Chapter 2 presents BCRs based on 3% and 7% discount rates, consistent with OMB procedures.)

- Wildfire protection for the Virginia Harris Cockrell Cancer Research Center in Smithville, Texas. A component of the University of Texas M.D. Anderson Cancer Research Center, the center lies on a tract of 713 acres with a high wildfire risk, as defined by the Southern Wildfire Risk Assessment. This risk has been evident in recent years: a number of significant wildfires have occurred near the facility. The mitigation strategy to protect the center from wildfire damage included establishing more than 23 acres of zone-2 and zone-3 defensible areas surrounding the property, and hardening and fire-proofing the exterior of the Griffin Building, which houses the research animals used by the center. The project cost \$1.975 million. The project also installed a wildfire sprinkler system on the exterior of the Griffin Building, which is fully automated and independent of public power and water sources. This project created a strong barrier to the onset of wildfires, in particular protecting the research animals, which are of great value. The applicant evaluated the project in 2010 using the FEMA BCA Tool (version 4.1.3) and found an overall BCR of 7.7. The current FEMA BCA Tool (version 5.3) does not seem to be able to handle this project (it lacks fire data). USFS BPs for this site and methods developed in the study of above-code benefits of this project both suggest a BCR of less than 1.
- Creation of defensible space and replacement of 410 window units on the five-story Mt. St. Francis nursing home in Colorado Springs, Colorado, which was built in 1915 for a total project cost of \$420,000. These improvements permit sheltering in place of the nursing home patients and staff, rather than requiring staff and residents to evacuate in case of wildfire. Detailed data for the facility were unavailable but, given that the facility has 108 beds, the project team estimated the total facility to have a replacement cost (new) of \$30 million. Using the FEMA BCA Tool version 5.3 with a discount rate of 2.13%, the project team estimated a BCR of 10.5. This value does not account for the costs to evacuate elderly patients nor the frailty of the patients—meaning that evacuating them might hurt them. If the project team were able to include the benefit associated with a lower chance of harm during evacuation (because evacuation would be unnecessary), the BCR would be higher.

With a few exceptions, the data that FEMA was able to provide on remaining projects contained insufficient information to directly determine BCRs. For example, a number of projects involved private residential roof replacement—that is, replacing a combustible wood shake roof with a non-combustible roof. In these programs, homeowners typically received 70% of the new roof cost up to a maximum (typically) of \$7,500. In many cases and for various reasons, homeowners opted to spend substantially more than this, but the total amount spent is not recorded in the project's electronic data. Without cost, one cannot estimate a BCR. Incidentally, to qualify for this roof subsidy, the homeowner was typically required to have, or newly create, a defensible space around the home (a not inconsiderable expense). Several other programs consisted solely of vegetation management of public or private lands and, in a few

cases, subsidies for residential sprinklers. In all these cases, the project data contained insufficient data to directly estimate a BCR.

### 5.15. PRIVATE-SECTOR WUI RETROFIT

Table 5-37 summarizes the estimated cost to retrofit a building to comply with the International Wildland-Urban Interface Code’s chapter-5 requirements of classes 1, 2, and 3 ignition-resistant construction. The table shows costs for all three classes in two parts: building (meaning the costs for cladding, glazing, and foundation enclosure) and vegetation control (meaning the present value over a 75-year life of the property to maintain a defensible space around the house that is relatively free of excess fuel).

The three classes of ignition-resistant construction differ by the fire hazard severity (moderate, high, or extreme), whether the lot provides the required amount of defensible space (between 30 feet and 100 feet from the house, depending on fire hazard severity), and whether firefighting water supply requirements are met (a source less than 1,000 ft from the house having flow capacity of at least 1,000 gallons to 1,500 gallons per minute, depending on house size). The 2018 International Wildland-Urban Interface Code probably would mostly apply in places with high to extreme fire hazard severity, which would require class 1 or 2 ignition-resistant construction. The geometric mean of the two suggests a retrofit cost of approximately \$72,000 to reduce the appearance of excessive accuracy.

**Table 5-37:** Estimated cost to retrofit an existing home to comply with the 2018 International Wildland-Urban Interface Code.

	Class 1		Class 2		Class 3	
	Suburban	Rural	Suburban	Rural	Suburban	Rural
Building	\$72,200	\$80,900	\$64,200	\$65,400	\$3,000	\$3,000
Vegetation	\$5,000	0	\$2,500	0	\$1,250	\$1,250
Total	\$77,200	\$80,900	\$66,700	\$65,400	\$4,250	\$4,250
Average	\$79,050		\$66,050		\$4,250	

A key assumption reflected in the table (and differing from the examination of new construction to comply with the International Wildland-Urban Interface Code) is that the defensible space requirements for retrofitted buildings is achieved with a dry garden, meaning some combination of native fire-resistive plantings, gravel, or other non-combustible ground cover. This assumption results in significantly lower total cost to manage vegetation than was previously assumed for new construction.

Hazard varies within counties, so BCR was calculated for that portion of each county that is within the wildland-urban interface. It assumed a building life of 75 years and the three discount rates used elsewhere in this study. As elsewhere in this study, the retrofit benefits and costs were summed for all locations whose BCR exceeded 1.0. The ratio of the two sums is the nationwide total BCR for retrofit to the International Wildland-Urban Interface Code.

## NATURAL HAZARD MITIGATION SAVES:

The project team found that retrofit was cost effective for 2.45 million homes, meaning a total retrofit and maintenance cost of 2.45 million homes times \$72,000 per home, or \$176 billion. The overall nationwide benefit was estimated to be \$320 billion in avoided future losses, for a nationwide average benefit-cost ratio of 1.8:1, implying an average per-house benefit of \$130,000 in avoided future losses. The project team added 36% both to nationwide cost and to benefit to account for nearby nonresidential buildings, which brings the total nationwide cost to \$240 billion and the total nationwide benefit to \$430 billion.

The distribution of ignition-resistant construction classes is highly uncertain. The project team chose to use the geometric mean of class-1 and class-2 retrofit cost to be consistent with the project's policy of deliberately erring on the conservative (low-BCR) side in situations of high uncertainty. Conceivably the true mix might be much lower, say the geometric mean of the class-2 and class-3 ignition-resistant construction, in which case the average cost would be more like \$16,000. Taking the benefit to be constant (\$130,000 per house), the benefit-cost ratio could be as high as 8:1.

## 6. Utilities and Transportation Lifelines

### 6.1. INTRODUCTION

#### 6.1.1. Objectives

In 2018, a team of experts that contributed to the 2005 study undertook new research to update and expand the earlier study to include estimated BCRs for natural-hazard mitigation of utilities and transportation lifelines.

The project team studied a number of benefits, including property loss reduction, reduced deaths and nonfatal injuries, reduced incidence of PTSD, reduced direct and indirect business-interruption losses, and reduced losses associated with environmental impacts. The team acknowledged benefits for a reasonable lifespan of the mitigation measure: 75 to 100 years, depending on the infrastructure being mitigated. The team discounted monetary benefits at three discount rates: the cost of borrowing, 3%, and 7% per year, but did not discount death or injury benefits. However, costs do include up-front and long-term maintenance costs.

Methodologies reflect those presented in the *2017 Interim Report* or well-established models of hazard (the occurrence frequency with various levels of environmental excitation, such as flood depth) and vulnerability (the relationship between loss and degree of environmental excitation). In some cases, new methodological elements were required, in which case the project team thoroughly documented new methodologies in this report. In no case were proprietary models used. All new methodologies were vetted by an independent oversight committee of experts—independent in the sense that they are empaneled by the National Institute of Building Sciences and not by the subcontractor charged with carrying out the analysis.

The project team set out to estimate BCRs for four categories of infrastructure: water and wastewater; electricity and telecommunications; ports; and roads and railroads, across four perils: earthquake, flooding, wind, and fire at the WUI. The project team sought to use EDA grants to represent the population of mitigation measures for each combination of peril and infrastructure with any significant mitigation activity. During the progress of its research, the project team found that, although EDA had issued 859 grants as of early 2017, only 16 appeared to fund natural-hazard mitigation of utilities and transportation lifelines. Of these, the team was able to acquire sufficient data to estimate BCRs for 12 mitigation investments. Because too few EDA grants were available to provide statistical value, the project team modified its objectives. In light of these limited data, the team instead decided to analyze the grants as case studies to show the degree to which mitigation of utilities and transportation lifelines can be cost effective. In some cases, new analytical procedures were developed and documented to provide other analysts with new tools to use in BCA.

## NATURAL HAZARD MITIGATION SAVES:

The 12 summarized grants do not capture all common, practical retrofit measures for utilities and transportation lifelines (particularly in regards to making water supply systems, electric utility infrastructure and highway bridges better resistant to earthquakes). The project team undertook analysis of additional mitigation measures to address these gaps.

Finally, the project team speculated that prescribed burns to reduce turbidity in water-supply reservoirs might represent a cost-effective mitigation measure to reduce impacts on water supply from fire at the wildland-urban interface. The thought was that wildfires would burn off the vegetation that stabilizes soil, and that later storm runoff could carry soil and bacteria downhill into reservoirs, producing turbidity and additional biochemical oxygen demand. Following consultation with several water agencies the project team found that turbidity in reservoirs after wildfires could be readily addressed much less expensively without performing prescribed burns. Prescribed burns would almost certainly produce very small BCRs, at least when benefits are compared to lower-cost strategies to deal with reservoir turbidity.

## 6.2. BENEFIT-COST ANALYSES OF 12 EDA GRANTS

### 6.2.1. EDA-Funded Flood Mitigation for Roads and Railroads

#### 6.2.1.1. Elevate Rail in Coralville, Iowa

*Summary of the Grant.* EDA, under its Economic Adjustment Assistance program, provided a grant of \$7.8 million in 2010 USD (approximately \$8.3 million in 2018) to the city of Coralville, Iowa, to elevate rail next to the Iowa River and to elevate nearby trails. The elevated rail bed would protect rail traffic along the line: approximately two trains per day, according to a crossing inventory report filed with the U.S. Federal Railroad Administration (FRA) and available through FRA's GIS Web Application.<sup>27</sup> The elevated rail bed and elevated trails were also intended to act as levees to protect buildings along the city's Iowa River shoreline near the rail bed. Figure 6-1 shows the locations of the elevated rail bed. The stretch of rail north of the yellow pushpin in the figure runs just east of First Avenue. The stretch south and east of the yellow pushpin runs just north of Second Street. A creek flows into the Iowa River near the pushpin. Satellite imagery shows elevated trails adjacent to the creek; these appear to be the ones mentioned in grant data.

The original rail bed appears to have had a lowest elevation of approximately 645 ft above sea level (ASL), raised to approximately 651 ft ASL. FEMA FIRMettes<sup>28</sup> suggest that the 100-year and 500-year floodplains near the rail have upper edges at approximately 645 ft ASL and 647 ft ASL, respectively. (Elevations are calculated here using the datum in Google Earth, as opposed to that of the FEMA FIRMettes.) A conservative estimate from satellite imagery of buildings just west of First Avenue and south of Second Street suggests 1.5 million ft<sup>2</sup> of buildings, in approximately equal proportions of dwellings and workplaces. Using a replacement cost of \$200/ft<sup>2</sup>, plus 50% added for content value, the project team can

---

<sup>27</sup> See <http://fragis.fra.dot.gov/GISFRASafety/>.

<sup>28</sup> A FIRMette is a full-scale section of a Flood Insurance Rate Map (FIRM).

## NATURAL HAZARD MITIGATION SAVES:

conservatively estimate \$460 million in protected property. Satellite imagery of First Avenue and Second Street suggest traffic flow of 25,000 trips per day.



Figure 6-1: Elevated rail in Coralville, Iowa.

**Flood hazard.** Using the elevations and exceedance frequencies associated with a 0.2% and 1% annual chance of flooding, the researchers estimated a relationship between elevation and exceedance frequency (a flood hazard curve) by assuming that the natural logarithm of exceedance frequency varies linearly with elevation.

**Direct damage to buildings.** The Hazus flood module provides a vulnerability function for a variety of building types. The analysis for this project uses a vulnerability function for 2-story buildings without basements.

**Loss of use duration and costs.** The project team conservatively estimated that delayed use of rail would cost \$264/train-hour in 2018 USD (Schlake et al. 2011). The figure considers cost of cars, locomotives, fuel, and labor, considering both actual and opportunity costs for an “average” train of 69 cars and 2.7 locomotives per train. The project team assumed that restoring function to a rail line requires one day per foot of flooding for floodwater to recede (as assumed elsewhere in this study) plus one day to inspect the line and clear debris.

If the flood-protection measure affects roadway access to residential property but does not affect actual damage to the property, then it is assumed that residents must stay in hotels and eat out, at a cost (or equivalent value) of the General Services Administration (GSA) local per-diem rate for meals and incidental expenses and accommodations. The project team assumed that one hotel room accommodates a typical



## NATURAL HAZARD MITIGATION SAVES:

family averaging 2.5 people. If the flood-protection measure affects roadway access to workplaces, the resulting direct BI cost is taken to be the state daily per-capita GDP. Indirect BI losses are taken as 0.5 times the total of ALE and direct BI losses, as shown previously in this study.

If the flood-protection measure actually did protect homes and workplaces, then for convenience, the project team estimated ALE, direct BI losses, and indirect BI losses as a factor of property losses taken from those estimated for federal grants for flood protection examined earlier in the study: a total of 30%.

**Casualties.** Hazus does not calculate flood-related deaths and injuries. However, for this grant, an estimate seemed practical, using the following methodology: in flooding, the primary causes of death is due to people drowning when they try to drive through flooded areas. Fatality statistics from four Texas floods between 1990 and 2001 show approximately 80 drownings (Table 6-1). The project team tabulated the population in the counties experiencing the greatest rainfall intensities (at least 12 inches of rain in 2 days) in each flood using U.S. Census data, and found that 8.9 million people were affected by the floods. The ratio of 80 deaths to 8.9 million people suggests a fatality rate of 0.90 per 100,000 population.

Approximately half of drownings in floods are attributed to people trying to drive through floodwaters, so the project team estimates 0.45 deaths per 100,000 people who would normally use a road that, in the analysis, is flooded or protected by a flood-mitigation measure. Counts of people were estimated one of three ways: (1) An engineer associated with the EDA grant provided an estimate of the number of people using the road; (2) A flood-protection measure protects a route into an otherwise isolated neighborhood, in which case the project team estimated the population of that neighborhood; or (3) the product of vehicle count per mile in satellite imagery, estimated traffic speed in miles per hour, and assuming 18 hours of traffic flow. The project team preferred method 1 over 2, and 2 over 3. Method 3 is crude, but should provide a reasonable estimate on an order-of-magnitude basis.

**Table 6-1:** Casualty modeling for flooded roads.

Location	Date	Deaths	Population	Counties
Central Texas	Oct 1998	29	1,585,304	Comal, Bexar, Guadalupe, and Gonzales, per <a href="https://pubs.usgs.gov/fs/FS-147-99/">https://pubs.usgs.gov/fs/FS-147-99/</a>
Houston	Jun 2001	22	3,668,308	Harris and Jefferson Counties
Dallas	May 1995	15	1,954,250	Dallas County
Central Texas	Dec 1991	14	1,699,000	Bexar and Travis, per <a href="https://pubs.er.usgs.gov/publication/wri954289">https://pubs.er.usgs.gov/publication/wri954289</a>
Total		80	8,906,862	

**Historic losses.** None seem to apply.

**Environmental losses.** None seem to apply.

## NATURAL HAZARD MITIGATION SAVES:

**Benefit-cost ratio.** Considering the foregoing project-specific information presented here, the general procedures presented here and elsewhere in the study, a 100-year project life, and a cost-of-borrowing discount rate of 2.2%, the project team calculated the project produced \$17 million in benefit at a cost of \$8.3 million, for an overall BCR of \$2.05 saved per \$1.00 invested, i.e., 2 to 1. The estimate may be overly conservative because it is unclear from satellite imagery how far the flood protection extends from the rail line. Most of the benefits are from reduced property loss, as shown in Figure 6-2. Using higher discount rates of 3% and 7%, the BCRs would be lower: 1.7 and 0.9, respectively.

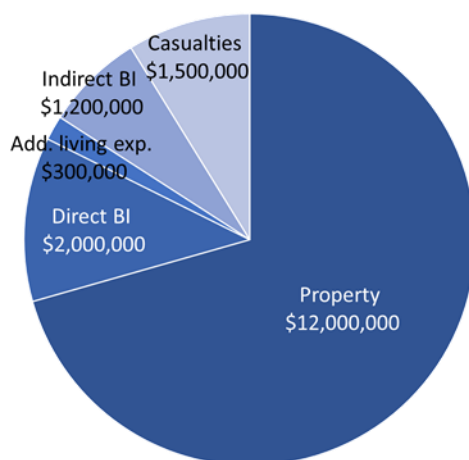

Figure 6-2: Estimated benefits from elevated rail and trails in Coralville, Iowa.

### 6.2.1.2. Elevate Rail near SEMO Port, Missouri

Summary of the grant. EDA, under its Economic Adjustment Assistance program, provided a grant of \$1.9 million in 2014 USD to the Southeast Missouri (SEMO) Regional Port Authority for various measures to improve rail through the port. A large portion of the grant, approximately \$1.5 million in 2018 USD, elevated rail along the Mississippi River, as shown in green highlighted in Figure 6-3. The work elevated the rail from BFE -9.5 ft (that is, 9.5 feet below BFE) to BFE -4 ft (i.e., 4 feet below BFE); the grantee suggested that it did not seem cost effective to better protect the rail in light of the much greater cost that would have been required. Grant data and FEMA FIRMettes suggest nearby 100-year and 500-year floodplains have upper edges about 352 ft ASL and 355 ft ASL, respectively. The grantee estimated traffic at 8 to 21 trains per week.

**Flood hazard.** Using the elevations and exceedance frequencies associated with a 0.2% and 1% annual chance of flooding, the project team estimate a relationship between elevation and exceedance frequency (a flood hazard curve) by assuming that the natural logarithm of exceedance frequency varies linearly with elevation.

**Loss of use duration and costs.** As used elsewhere in this study, delayed use of rail is conservatively estimated to cost \$264/train-hour in 2018 USD (Schlake et al. 2011). That figure considers the cost of cars, locomotives, fuel, and labor, considering both actual and opportunity costs for an “average” train of 69

## NATURAL HAZARD MITIGATION SAVES:

cars and 2.7 locomotives per train. It is assumed that restoring function to a rail line requires one day per foot of flooding for floodwater to recede (as assumed elsewhere in this study) plus one day to inspect the line and clear debris.

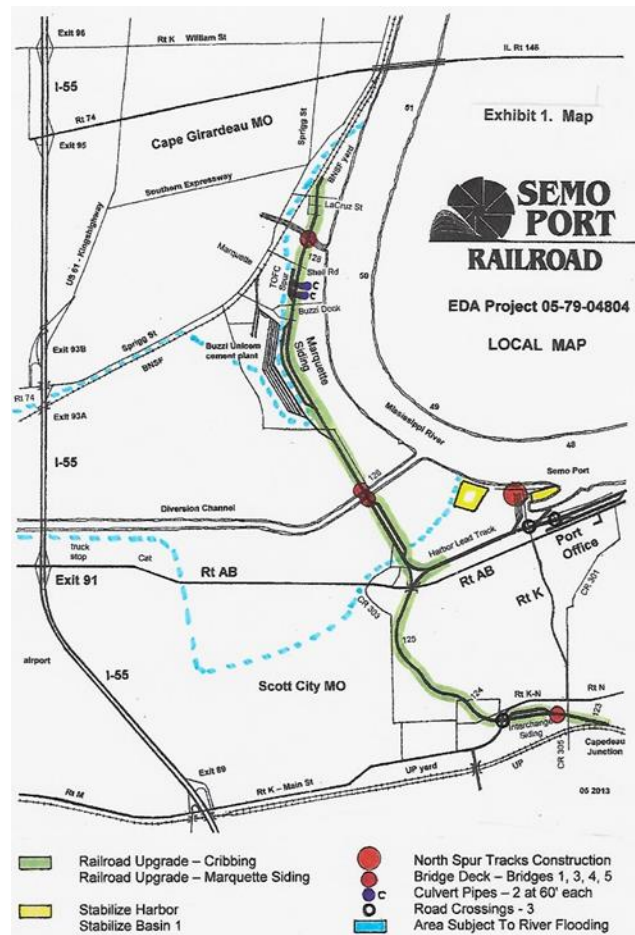

Figure 6-3: Elevated rail (green highlight) in the SEMO Port Railroad.

**Flood hazard.** Using the elevations and exceedance frequencies associated with a 0.2% and 1% annual chance of flooding, the project team estimate a relationship between elevation and exceedance frequency (a flood hazard curve) by assuming that the natural logarithm of exceedance frequency varies linearly with elevation.

**Loss of use duration and costs.** As used elsewhere in this study, delayed use of rail is conservatively estimated to cost \$264/train-hour in 2018 USD (Schlake et al. 2011). That figure considers the cost of cars, locomotives, fuel, and labor, considering both actual and opportunity costs for an “average” train of 69 cars and 2.7 locomotives per train. It is assumed that restoring function to a rail line requires one day per foot of flooding for floodwater to recede (as assumed elsewhere in this study) plus one day to inspect the line and clear debris.

## NATURAL HAZARD MITIGATION SAVES:

*Casualties.* None seem to apply.

*Historic losses.* None seem to apply.

*Environmental losses.* None seem to apply.

*Benefit-cost ratio.* Considering the foregoing project-specific information presented here and a conservative traffic estimate of 13 trains per week (the geometric rather than arithmetic mean of the two traffic estimates) the general procedures presented here and elsewhere in the study, a 100-year project life, and a cost-of-borrowing discount rate of 2.2%, the project produces \$3.0 million in benefit at a cost of \$1.5 million, for an overall BCR of \$2.00 saved per \$1.00 invested, i.e., 2 to 1. All of the benefits are from reduced BI losses, as shown in Figure 6-4. Using higher discount rates of 3% and 7%, the BCRs would be lower: 1.5 and 0.7, respectively.

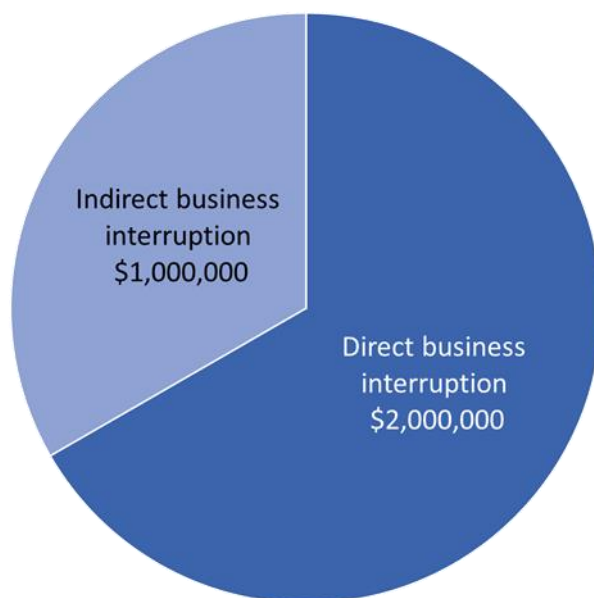

Figure 6-4: Estimated benefits from elevating rail near SEMO Port, Missouri.

### 6.2.1.3. Elevate Road in Seward, Nebraska

*Summary of the grant.* EDA, under its Economic Adjustment Assistance program, provided a grant of \$2.2 million in 2010 USD (approximately \$2.6 million in 2018) to Seward, Nebraska, to elevate and extend a road to an industrial facility. Only the portion of the project cost associated with elevating the road (approximately \$1.3 million) is considered here, because the extension constituted an expansion rather than remediation of the roadway. Figure 6-5 shows the location of the road, just south of the Big Blue River (the green space stretching from the middle top of the image to the middle right). The road does not provide protection to the industrial facility, which is at a slightly higher elevation. The FEMA FIRMettes suggest that the 100-year and 500-year floodplains near the road have upper edges of approximately 1,446 ft and 1,448 ft ASL, respectively. The road appears to have pre- and post-remediation elevations of

## NATURAL HAZARD MITIGATION SAVES:

1,441 and 1,449 ft ASL, respectively. The industrial facility has 500 employees, so the analysis assumes 500 trips.



Note: The BCA considers only the extension between the midpoint of the road (the middle pushpin) and east end (the right-hand pushpin).

Figure 6-5: Elevated and extended road in Seward, Nebraska.

**Flood hazard.** Using the elevations and exceedance frequencies associated with a 0.2% and 1% annual chance of flooding, the project team estimated a relationship between elevation and exceedance frequency (a flood hazard curve) by assuming that the natural logarithm of exceedance frequency varies linearly with elevation.

**Direct damage to buildings.** Not applicable.

**Loss of use duration and costs.** Loss of access costs \$139 per capita daily GDP per day, and the analysis assumed 2.5 people per each of 500 employees. No residences were protected, so no ALE apply.

**Casualties.** As described elsewhere, the project team estimated 0.45 deaths per 100,000 trips, and 500 trips in this particular case.

**Historic losses.** None seem to apply.

**Environmental losses.** None seem to apply.

**Benefit-cost ratio.** Considering the foregoing project-specific information presented here, the general procedures presented here and elsewhere in the study, a 100-year project life, and a cost-of-borrowing discount rate of 2.2%, the project team calculated that the project produced \$9.4 million in benefit at a cost of \$1.3 million, for an overall BCR of \$7.20 saved per \$1.00 invested, i.e., 7.2 to 1. Most of the benefits

## NATURAL HAZARD MITIGATION SAVES:

are from BI loss, as shown in Figure 6-6. Using higher discount rates of 3% and 7%, the BCRs are lower: 5.9 and 3.4, respectively.

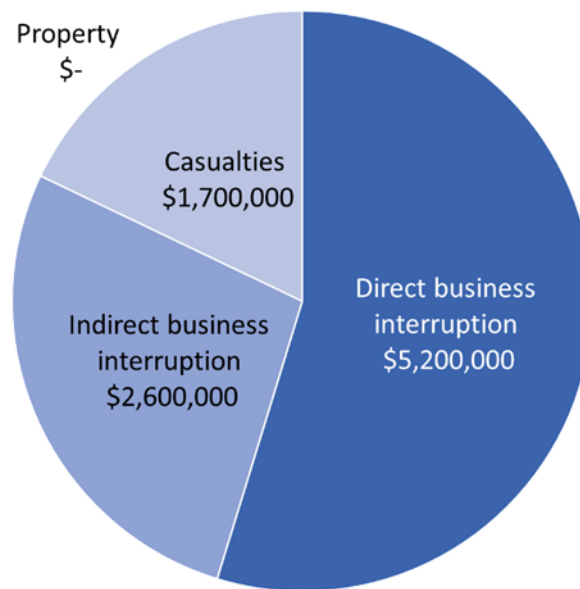
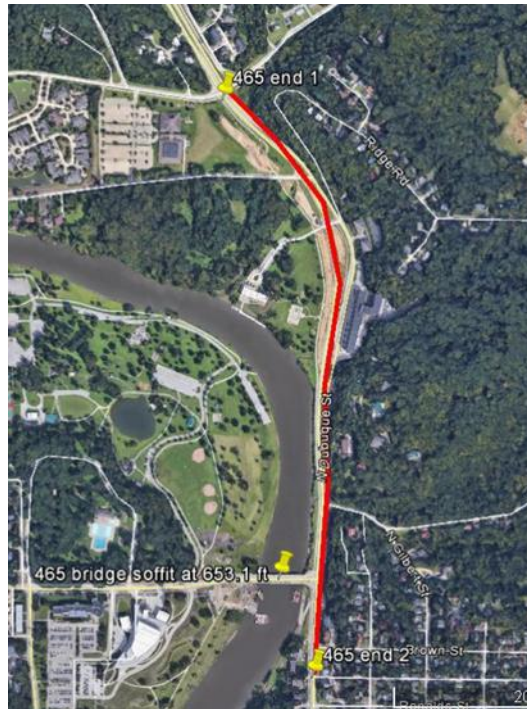

Figure 6-6: Estimated benefits from elevated access road in Seward, Nebraska.

### 6.2.1.4. Elevate Road and Reconstruct Bridge in Iowa City, Iowa

*Summary of the grant.* EDA, under its Economic Adjustment Assistance program, provided a grant for a project that ultimately cost \$40.6 million in 2018 USD to Iowa City, Iowa, to elevate 3,500 ft of a road and to reconstruct a bridge to an industrial facility. Figure 6-7 shows the location of the work: the Park Road Bridge and North Dubuque Street serve as an artery for 25,000 daily trips each way between Iowa City and Interstate 80. The road also provides the only access to a 1,000-bed University of Iowa residence hall, two apartment complexes, and a few other residences. The FEMA FIRMettes and city data suggest that the 100-year and 500-year floodplains near the road have upper edges of approximately 651 ft and 653 ft ASL, respectively, using the same datum as Google Earth. The road appears to have pre- and post-remediation elevations of 644 and 652 ft ASL, respectively.



**Figure 6-7:** Elevated roadway (North Dubuque Street, highlighted by the red line) and elevated bridge (Park Road Bridge over the Iowa River, yellow pushpin) in Iowa City, Iowa.

**Flood hazard.** Using the elevations and exceedance frequencies associated with a 0.2% and 1% annual chance of flooding, the project team estimated a relationship between elevation and exceedance frequency (a flood hazard curve) by assuming that the natural logarithm of exceedance frequency varies linearly with elevation.

**Direct damage to buildings.** Not applicable.

**Loss of use duration and costs.** Loss of access to homes for approximately 1,100 people costs \$146 per person per day using local GSA per diem rates and assuming two students per hotel room.

**Casualties.** As described elsewhere, the project team estimated 0.45 deaths per 100,000 trips, and 25,000 trips in this particular case.

**Historic losses.** None seem to apply.

**Environmental losses.** None seem to apply.

**Benefit-cost ratio.** Considering the foregoing project-specific information presented here, the general procedures presented here and elsewhere in the study, a 100-year project life, and a cost-of-borrowing discount rate of 2.2%, the project team calculated that the project produced \$456 million in benefit at a cost of \$40.5 million, for an overall BCR of \$11 saved per \$1.00 invested, i.e., 11 to 1. Most of the benefits are from avoided casualties—people who would drown because they try to drive through the flooded street,

## NATURAL HAZARD MITIGATION SAVES:

as shown in Figure 6-8. Using higher discount rates of 3% and 7%, the benefit-cost ratios are essentially the same, 11:1, because the analysis does not discount human life.

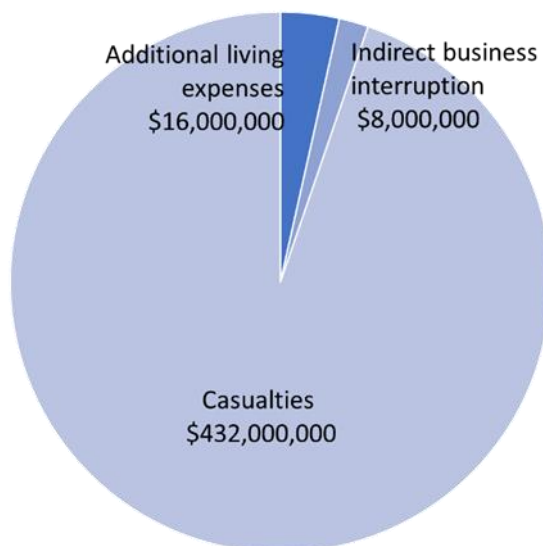

Figure 6-8: Estimated benefits of elevating access road and reconstructing bridge in Iowa City, Iowa.

### 6.2.1.5. Reconstruct Bridge in Ruidoso, New Mexico

*Summary of the grant.* EDA, under its Economic Adjustment Assistance program, provided a grant worth \$1.3 million in 2018 USD to Ruidoso, New Mexico, to reconstruct a bridge that provides access to the homes of 1,000 people. Figure 6-9 shows the location of the bridge, which spans the Rio Ruidoso. The bridge was raised slightly but greatly widened to double the flow beneath it, remediating the potential for overtopping of the bridge during heavy rainfall. The FEMA FIRMettes suggest that the 100-year and 500-year floodplains near the bridge have upper edges of approximately 6,823 ft and 6,831 ft ASL, respectively, although those elevations reflect the damming effect of the bridge. The road appears to have pre-remediation elevation of 6,823 ft ASL.



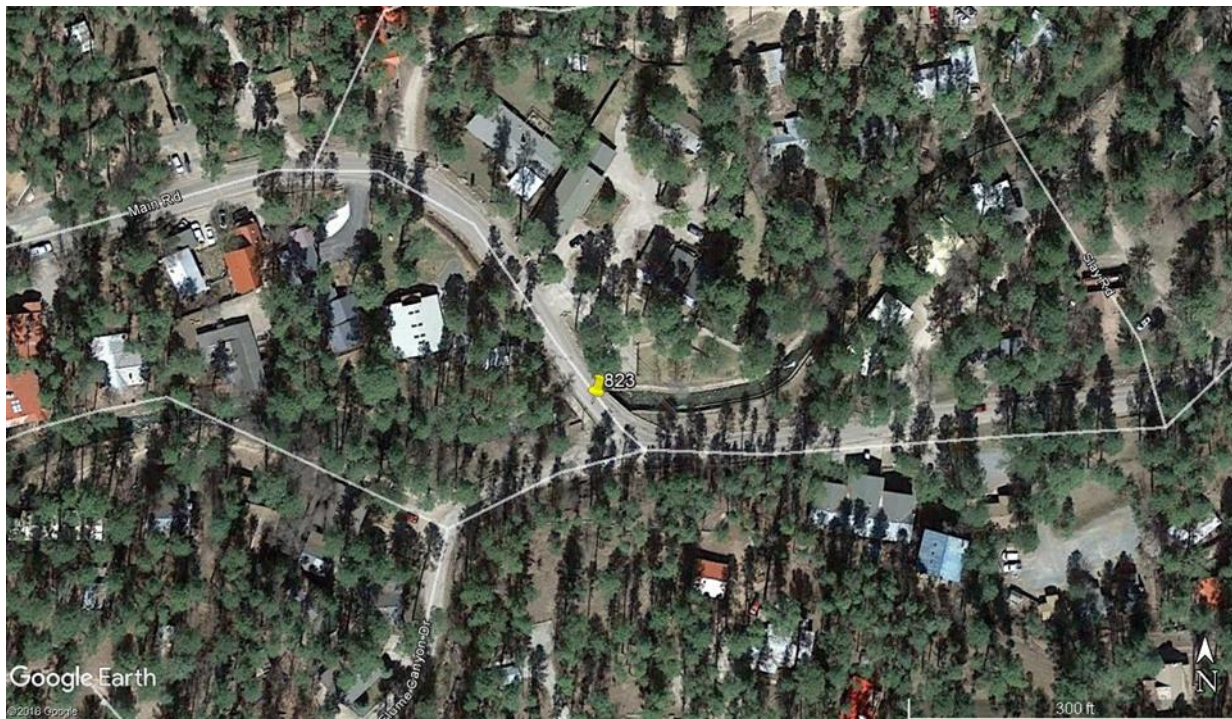

Figure 6-9: Reconstructed bridge (yellow pushpin) over Main Road in Ruidoso, New Mexico.

**Flood hazard.** Using the elevations and exceedance frequencies associated with a 0.2% and 1% annual chance of flooding, the project team estimated a relationship between elevation and exceedance frequency (a flood hazard curve) by assuming that the natural logarithm of exceedance frequency varies linearly with elevation. To approximate the effect of widening the floodway below the bridge, the project team treated the post-reconstruction elevation as having an elevation of 6,827 ft ASL.

**Direct damage to buildings.** Not applicable.

**Loss of use duration and costs.** Loss of access costs \$132 per capita for meals and accommodations.

**Casualties.** As described elsewhere, the project team estimated 0.45 deaths per 100,000 trips, and 1,000 trips in this particular case.

**Historic losses.** None seem to apply.

**Environmental losses.** None seem to apply.

**Benefit-cost ratio.** Considering the foregoing project-specific information presented here, the general procedures presented here and elsewhere in the study, a 100-year project life, and a cost-of-borrowing discount rate of 2.2%, the project team calculated that the project produced \$270,000 in benefit at a cost of \$1.3 million, for an overall BCR of \$0.21 saved per \$1.00 invested, i.e., 0.21 to 1, as shown in Figure 6-10. Using higher discount rates of 3% and 7%, the BCRs are lower: 0.17 and 0.10, respectively. A BCR below 1:1

## NATURAL HAZARD MITIGATION SAVES:

reflects that the grant decision is based on criteria other than the long-term average cost effectiveness of the mitigation measure.

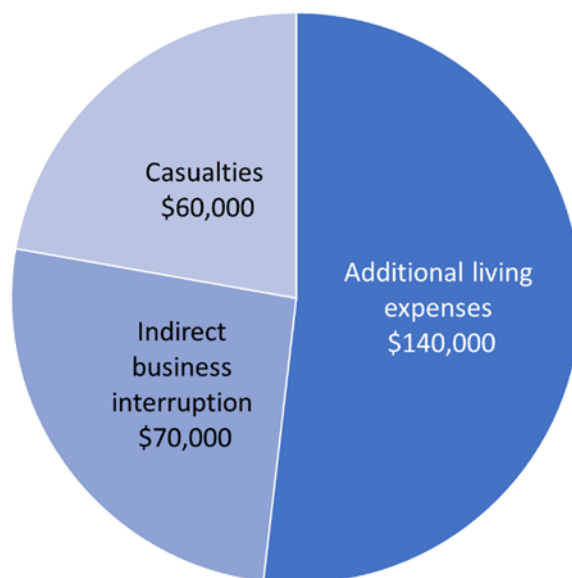

Figure 6-10: Estimated benefits from reconstructing the Main Road Bridge over Rio Ruidoso in Ruidoso, New Mexico.

### 6.2.2. EDA-Funded Flood Mitigation for Water and Wastewater Infrastructure

This section presents analyses of grants to mitigate natural-hazard risk to water and wastewater facilities. Some of the grants address water facilities, some address wastewater, and one addresses both.

#### 6.2.2.1. Elevate Water Treatment Plant Electrical Equipment in Portsmouth, Virginia

*Summary of the grant.* EDA, under its Economic Adjustment Assistance program, provided a grant in the amount of \$8.6 million in 2003 USD (approximately \$11.6 million in 2018) to Portsmouth, Virginia. The grant relocated the electrical equipment for Portsmouth's Lake Kirby water treatment facility from a location at 21 ft ASL (1 foot lower than the upper edge of FEMA's SFHA, the so-called 100-year floodplain, around 22 ft ASL), to a new location at 40 ft ASL (approximately 8 ft higher than the upper edge of the 500-year floodplain). Figure 6-11 shows the locations of the old and new electrical facility. The effort aimed to maintain water service during floods to the city's population of 96,200 people.



Figure 6-11: Portsmouth's water treatment plant: A) in 2003, and B) in 2015.

**Flood hazard.** Using the elevations and exceedance frequencies associated with a 0.2% and 1% annual chance of flooding, the project team estimated a relationship between elevation and exceedance frequency (a flood hazard curve) by assuming that the natural logarithm of exceedance frequency varies linearly with elevation.

**Direct damage to control building equipment.** The Hazus flood module provides a vulnerability function for small water treatment plants that operate by pressure.

**Loss of use duration and costs.** The project team assumed that restoring mechanical equipment at a water treatment plant to function requires one day per foot of flooding for floodwater to recede (as assumed elsewhere in this study) plus one week to disassemble, clean, and dry motors, pumps, and other rotating equipment, and less time to clean and dry electrical equipment. During that time, residences lack water for showers and toilets, so residents must relocate temporarily. They might stay in hotels, at a cost of the GSA per diem for lodging (one room for a household of up to three) plus the GSA per diem rate for meals and incidental expenses (one per each person). It may be that people stay with friends or family or in a shelter at little or no cost, but economists see the value lost as worth something. Residents would rather be at home. The measure of that preference, in this case, is taken as the GSA per diem rates.

Businesses cannot operate without functioning bathrooms, if a water treatment plant is inoperative, all businesses are similarly affected. Customers or employees cannot simply go next door. Nor are there likely to be portable toilets available for the entire community at a moment's notice. The analysis therefore estimates the direct BI costs resulting from loss of potable water as the state-average per-capita daily GDP. Indirect BI is taken as 0.5 times the sum of ALE and direct BI loss, as elsewhere in this study.

The local GSA per diem for accommodations, for meals and incidental expenses, and the state per-capita daily GDP are \$87, \$61, and \$141 respectively.

**Casualties.** As discussed elsewhere in this study, the primary cause of death in flooding is due to people drowning when they try to drive through flooded areas. Casualty losses are therefore assumed to be zero in this case, and there seems to be no reason to suspect that PTSD would occur from temporary loss of potable water service.

## NATURAL HAZARD MITIGATION SAVES:

*Historic and environmental losses.* None seem to apply.

*Benefit-cost ratio.* Considering the project-specific information presented here, general procedures presented elsewhere in the study, a 100-year project life, and a cost-of-borrowing discount rate of 2.2%, the project team calculated that the project produced \$112 million in benefit at a cost of \$11.6 million, for an overall BCR of \$9.70 saved per \$1.00 invested, i.e., 10 to 1. Most of the benefits result from reduced BI (Figure 6-12). At discount rates of 3% and 7%, the BCRs are lower: 8 and 3, respectively.

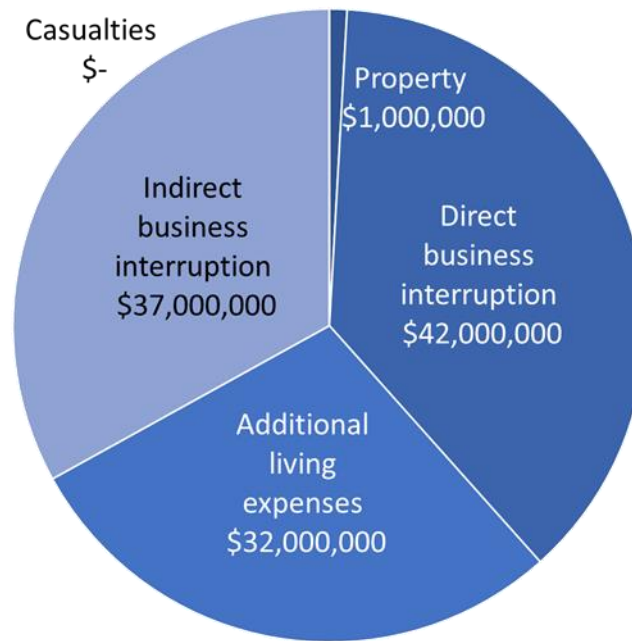

Figure 6-12: Estimated benefits from elevating electrical equipment at the water treatment plant in Portsmouth, Virginia.

### 6.2.2.2. Columbus Junction, Iowa, Water Treatment Plant Relocation

*Summary of the grant.* EDA, under EDA's Economic Adjustment Assistance program, provided a grant of \$4.6 million to Columbus Junction, Iowa. The grant relocated the city's water treatment facility from a location at 587 ft ASL (2 feet lower than the upper edge of FEMA's SFHA, the so-called 100-year floodplain, around 589 ft ASL), see Figure 6-13, to a new location at 594 ft ASL (2 feet higher than the upper edge of the 500-year floodplain, around 592 ft ASL, Figure 6-14). The goal was to maintain water service to Columbus Junction during floods. The water treatment plant serves 60 commercial customers and 600 residential customers, whose total population measures 1,850.



Note: In this FEMA FIRMette, the blue area represents the special flood hazard area, with at least 1% annual chance of flooding. The brown areas have between 0.2% and 1% annual chance of flooding.

Figure 6-13: The old water treatment plant in Columbus Junction, Iowa.



Figure 6-14: The new water treatment plant in Columbus Junction, Iowa.

**Flood hazard.** Using the elevations and exceedance frequencies associated with a 0.2% and 1% annual chance of flooding, the project team estimated a relationship between elevation and exceedance frequency (a flood hazard curve) by assuming that the natural logarithm of exceedance frequency varies linearly with elevation.

**Direct damage to control building equipment.** The Hazus Flood Model provides a vulnerability function for small water treatment plants that operate by pressure.

**Loss of use duration and costs.** It is assumed here that restoring the water treatment plant to function requires one day per foot of flooding for floodwater to recede (as assumed elsewhere in this study) plus one week to disassemble, clean, and dry motors, pumps, and other rotating equipment, and less time to clean and dry electrical equipment. During that time, residences lack water for showers and toilets, so occupants have to relocate temporarily. They might stay in hotels, at a cost of the GSA per diem for lodging (one room for a household of up to three) plus the GSA per diem rate for meals and incidental expenses (one per each person). It may be that people stay with friends or family or in a shelter at little or

## NATURAL HAZARD MITIGATION SAVES:

no cost, but economists see the value lost as worth something. Residents would rather be at home. The measure of that preference is taken here as the GSA per diem rates.

Businesses cannot operate without functioning bathrooms. If a water treatment plant is inoperative, all businesses are similarly affected. Customers or employees cannot go next door. Nor are there likely to be portable toilets available for the entire community at a moment's notice. The analysis estimates direct BI loss as the state-average per-capita daily GDP. Indirect BI loss is taken as 0.5 times the sum of ALE and direct BI loss, as elsewhere in this study.

In the case of Columbus Junction, Iowa, GSA per diems for accommodations and for meals and incidental expenses are \$91 and \$51, respectively. The per-capita daily GDP is \$139.

**Casualties.** As discussed elsewhere in this study, the primary cause of death in flooding is due to people drowning when they try to drive through flooded areas. Casualty losses are therefore assumed to be zero in this case, and there seems no reason to suspect that PTSD would occur from temporary loss of potable water service.

**Historic and environmental losses.** None seem to apply.

**Benefit-cost ratio.** Considering the foregoing project-specific information presented here, the general procedures presented elsewhere in the study, a 100-year project life, and a cost-of-borrowing discount rate of 2.2%, the project team calculated that the project produced \$5.9 million in benefit at a cost of \$4.6 million, for an overall BCR of \$1.30 saved per \$1.00 invested, i.e., 1.3 to 1. Most of the benefits are from reduced BI to the community, as shown in Figure 6-15. Using higher discount rates of 3% and 7%, the BCRs are lower, 1.0 and 0.5, respectively. The BCR is relatively low compared to other mitigation for water treatment plants because the measure relocates the water treatment plant, which is relatively costly compared with other flood-protection measures considered here, such as building berms and elevating electrical equipment.

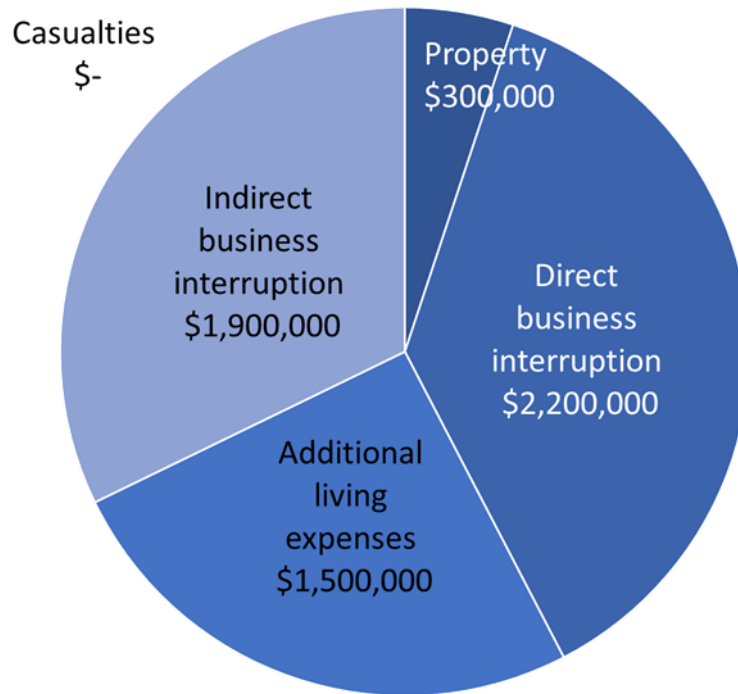

Figure 6-15: Estimated benefits from new water treatment plant in Columbus Junction, Iowa.

**6.2.2.3. Relocate Wastewater Treatment Plant out of Floodplain in Iowa City, Iowa.**

*Summary of the grant.* EDA, under its Economic Adjustment Assistance program, provided a grant of \$46.5 million in 2010 USD (approximately \$54 million in 2018) to Iowa City, Iowa. The purpose of the grant was to redirect wastewater from the city’s north wastewater treatment plant, in the FEMA SFHA (the 100-year floodplain), to its south wastewater treatment plant, and expand the south plant to handle the greater demand. Expansion of the south plant cost approximately \$40.6 million in 2010 USD (\$47 million in 2018). Figure 6-16 shows the locations of the two facilities.

The grant aimed to maintain, during floods, wastewater service to the city’s population of 74,400 people. The ground at the north plant had an elevation of approximately 646 ft ASL. The 100-year and 500-year floodplains near the site of the north plant have upper edges about 650 ft ASL and 652 ft ASL, respectively. The south plant also had some risk of flooding (see Figure 6-17), but the expansion mitigated individual buildings and equipment by raising equipment within buildings, raising transformer pads, building berms, and other measures, to a level one foot above the elevation of 500-year flooding. The FEMA FIRMette suggests a 642-ft ASL elevation of the edge of the 100-year floodplain at the south treatment plant. Estimates (Stanley Consultants 2011) placed the upper edge of the 500-year floodplain at approximately 645 ft ASL, and the lowest equipment needing elevation about 644 ft ASL. Hazus values a medium-sized wastewater treatment plant at \$200 million (2003 USD) or \$276 million in 2018 USD.

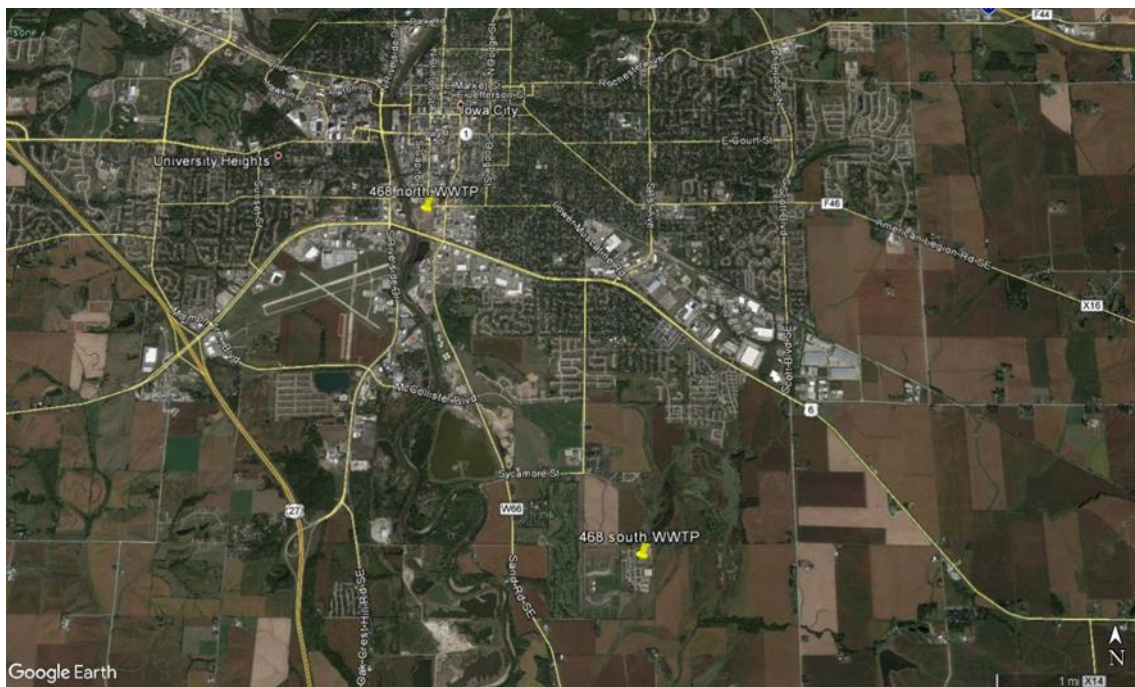

Figure 6-16: Wastewater treatment plant sites in Iowa City, Iowa : the north plant (denoted 468 north WWTP) and the south plant (denoted 468 south WWTP).





0 150 300 Feet

Figure 5-1  
Flood Inundation  
South WWTP - 500 Year Event:

Figure 6-17: The estimated extent of flooding at the south waste water treatment plant in Iowa City, Iowa, before mitigating sensitive buildings and components, using a 0.2% annual exceedance probability (500-year flood). (Stanley Consultants 2011)

*Flood hazard.* Using the elevations and exceedance frequencies associated with a 0.2% and 1% annual chance of flooding, the project team estimated a relationship between elevation and exceedance

## NATURAL HAZARD MITIGATION SAVES:

frequency (a flood hazard curve) by assuming that the natural logarithm of exceedance frequency varies linearly with elevation.

**Direct damage to wastewater treatment plant equipment.** The Hazus flood module provides a vulnerability function for wastewater treatment plants. The methodology provides different labels of systems that distinguish them by size (small, medium, and large), but the vulnerability functions for different sizes are identical. The methodology indicates that the system ceases to function when any flooding occurs.

**Loss of use duration and costs.** It is assumed here that restoring the function of a wastewater treatment plant requires one day per foot of flooding for floodwater to recede (as assumed elsewhere in this study) plus one week to disassemble, clean, and dry motors, pumps, and other rotating equipment, and less time to clean and dry electrical equipment. During that time, if the wastewater treatment plant were damaged, it is assumed here that homes and businesses are allowed to continue using the sewer system in Iowa City at a voluntarily reduced rate and that untreated wastewater flows into overland, through unnamed creeks, downstream to the Iowa River, then 25 miles past Hills, Columbus Junction, and Wapello to the Mississippi River. It is assumed that by the time it reaches Columbus Junction, the untreated wastewater is diluted to the point that the Columbus Junction Water Treatment Plant can handle the additional contaminants and that no ALE or BI costs are incurred there.

**Casualties.** As discussed elsewhere in this study, the primary cause of death in flooding is due to people drowning when they try to drive through flooded areas. Casualty losses are therefore assumed to be zero in this case, and there seems to be no reason to suspect that PTSD would occur from temporary loss of wastewater service.

**Historic losses.** None seem to apply.

**Environmental losses.** Regardless of loss-of-use costs, if either wastewater treatment plant were to flood, untreated wastewater represents a hazardous spill that would pollute the Iowa River and make it unusable for recreation for a season. It is problematic to assign a monetary value to the resulting environmental impact. As noted elsewhere in this study, Whitehead et al. (2000) estimate the revealed-preference value of \$95 per visit to a recreation area (in 2018 USD). The project team assumed that pollution from flooding of the wastewater treatment plant would impair the recreational value of the Iowa River between Iowa City and the Mississippi River for a season. The analysis attributes that amount to each person who lives between Iowa City and the Mississippi River: in Iowa City (population 74,400), Riverside (1,000), Hills (800), Columbus Junction (1,800), and Wapello (2,000), essentially assuming one foregone visit per person near the river. The project team therefore estimated the environmental impact from flooding of either wastewater treatment plant to be worth \$7.6 million to avoid.

**Benefit-cost ratio.** Considering the foregoing project-specific information presented here, the general procedures presented elsewhere in the study, a 100-year project life, and a cost-of-borrowing discount rate of 2.2%, the project team calculated that the project produced \$195 million in benefit at a cost of \$54 million, for an overall BCR of \$3.60 saved per \$1.00 invested, i.e., 4 to 1. The BCR is relatively low compared

## NATURAL HAZARD MITIGATION SAVES:

with other water- and wastewater-related grants considered here because of the assumption that Iowa City homes and businesses would not have to cease operations solely because of flooding of either wastewater treatment plant. That assumption may be overly conservative: conceivably, untreated wastewater near businesses at the south end of Iowa City (just downstream of the wastewater treatment plant) might so impair air quality and public safety that some businesses would cease operations until cleanup were completed. In any case, most of the benefits are from property loss to the wastewater treatment plants, as shown in Figure 6-18. Using higher discount rates of 3% and 7%, the BCRs are lower: 2.3 and 1.04, respectively.

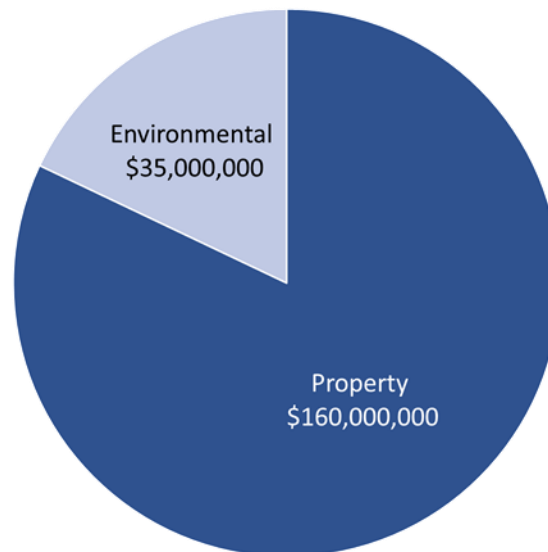

**Figure 6-18:** Estimated benefits from decommissioning the Iowa City, Iowa, north wastewater treatment plant and elevating or otherwise protecting critical equipment at the south plant.

### 6.2.2.4. Protect Water and Wastewater Treatment Plants in Greenville, North Carolina from Flood

**Summary of the grant.** EDA, under its Economic Adjustment Assistance program, gave \$4.8 million in 2001 USD (approximately \$6.8 million in 2018) to Greenville, North Carolina to construct a flood-protection berm and pumping station for Greenville's water treatment plant. The grant also paid to raise a flood protection wall and a retaining wall at the Northside Wastewater Treatment Plant. Figure 6-19A shows the locations of the two facilities. The grant aims to maintain, during floods, the water and wastewater service to the city's population of 91,500 people. The ground at the water treatment plant has an elevation of 21 ft ASL; the crest of the berm rises to 33 ft ASL. The 100-year and 500-year floodplains have upper edges approximately 24 ft ASL and 27 ft ASL, respectively. Ground level at the wastewater treatment plant is 18 ft ASL; its berm has crest elevation of approximately 21 ft ASL. The edges of the 100-year and 500-year floodplains are about 17 ft and 19 ft ASL. Hazus values a medium-sized water-treatment plant at \$100 million in 2003 USD, or \$138 million in 2018 USD. It values a wastewater treatment plant at \$200 million in 2003 USD or \$276 million in 2018 USD.



**Figure 6-19:** A. Water treatment plant (denoted 53 WTP) and wastewater treatment plant (denoted 53 WWTP) sites in Greenville, North Carolina. B. Image of the water treatment plant, with berm highlighted in red. C. Image of the wastewater treatment plant.

**Flood hazard.** Using the elevations and exceedance frequencies associated with a 0.2% and 1% annual chance of flooding, the project team estimated a relationship between elevation and exceedance frequency (a flood hazard curve) by assuming that the natural logarithm of exceedance frequency varies linearly with elevation.

**Direct damage to water treatment plant and wastewater treatment plant equipment.** The Hazus Flood Model provides a vulnerability function for water treatment plants that operate by pressure and another for wastewater treatment plants. The methodology provides different labels of systems that distinguish them by size (small, medium, and large), but the vulnerability functions for different sizes are identical. The methodology also indicates that the system ceases to function when any flooding occurs.

**Loss of use duration and costs.** It is assumed here that restoring the function of a water treatment plant or of a wastewater treatment plant requires one day per foot of flooding for floodwater to recede (as assumed elsewhere in this study) plus one week to disassemble, clean, and dry motors, pumps, and other rotating equipment, and less time to clean and dry electrical equipment. During that time, if the water treatment plant is damaged, showers and toilets cannot be used in residences and occupants must

## NATURAL HAZARD MITIGATION SAVES:

relocate temporarily. They might stay in hotels, at a cost taken to be the GSA per diem for lodging (one room for a household of up to three people) plus the GSA per diem rate for meals and incidental expenses (one per person). It may be that people stay with friends or family or in a shelter at little or no cost, but economists still see the lost value as worth something. Residents would rather be at home, and the measure of that preference, in this case, is taken as the GSA per diems rates.

The project team also assumed that businesses cannot operate without functioning bathrooms. If a water treatment plant is inoperative, all businesses are similarly affected. Customers or employees cannot simply go next door. Nor are there likely to be portable toilets available for the entire community at a moment's notice. The analysis therefore assumes that without water, direct BI costs the state-average per-capita daily GDP. Indirect BI is taken as 0.5 times the total ALE and direct BI loss, as elsewhere in this study.

The local GSA per diem rates for accommodations and for meals and incidental expenses are \$115 and \$59, respectively. The state per-capita daily GDP is \$121.

**Casualties.** As discussed elsewhere in this study, in flooding, the primary cause of deaths is due to people drowning when they try to drive through flooded areas. Casualty losses are therefore assumed to be zero in this case, and there seems to be no reason to suspect that PTSD would occur from temporary loss of potable water service.

**Historic losses.** None seem to apply.

**Environmental losses.** If the wastewater treatment plant floods, untreated wastewater would flow overland to the nearby Tar River, polluting the river as it passes nearby Washington, North Carolina, and 25 miles downstream into Pamlico Sound, part of the Cape Hatteras National Seashore. The pollution would impair the recreational value of Pamlico Sound for approximately one season. Whitehead et al. (2000) used revealed-preference data to value a recreational visit to Pamlico Sound at \$64 per user in 2000 USD, or \$95 per visit in 2018 USD. The National Park Service reports that 2.4 million people visit the Cape Hatteras National Seashore each year (National Park Service 2018). Thus, the environmental costs of polluting the national park can be estimated at \$228 million. In addition, Pamlico Sound produces \$20 million per year in commercial fishing (Sea Grant 2017). The project team therefore estimated the acceptable cost to avoid environmental losses associated with flooding of the wastewater treatment plant to be \$248 million.

**Benefit-cost ratio.** Considering the foregoing project-specific information presented here, the general procedures presented elsewhere in the study, a 100-year project life, and a cost-of-borrowing discount rate of 2.2%, the project team calculated that the project produced \$212 million in benefit at a cost of \$6.8 million, for an overall BCR of \$31.00 saved per \$1.00 invested, i.e., 31 to 1. The BCR is so high because it costs relatively little to build the flood-protection systems that protect a relatively large value. Most of the benefits are from reduced BI to the community, but environmental benefits are also significant, as shown in Figure 6-20. Using higher discount rates of 3% and 7%, the BCRs are lower: 28 and 13, respectively.

## NATURAL HAZARD MITIGATION SAVES:

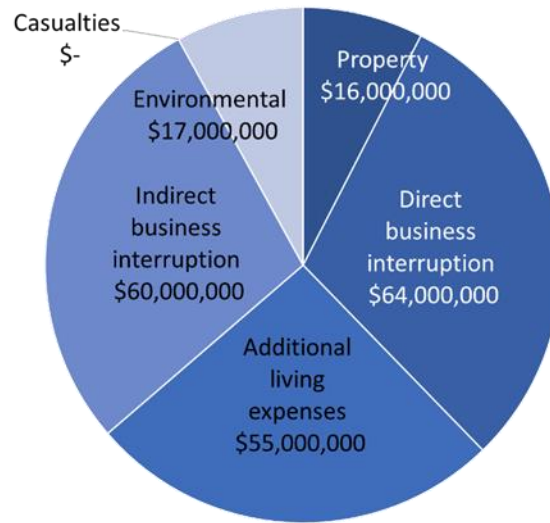

Figure 6-20: Estimated benefits from adding flood protection to the water and wastewater treatment plants in Greenville, North Carolina.

### 6.2.3. Flood Mitigation for Electric and Telecommunications Substation in Reedsburg, Wisconsin

*Summary of the grant.* EDA, under its Economic Adjustment Assistance program, provided a grant in the amount of \$1.8 million to the City of Reedsburg, Wisconsin. Among its other products, the grant expended \$235,000 to build a facility called a telecommunications/electric switching station, essentially a dual-purpose telephone central office and control building for the adjacent substation yard. The building replaced an older building about 40 feet away but 4 feet lower in elevation. See Figure 6-21.



Figure 6-21: Electrical and telephone switching stations in Reedsburg, Wisconsin. The old one is to the right with the green cabinet next to it; the new one is to the left, behind the pickup truck.

## NATURAL HAZARD MITIGATION SAVES:

**Flood hazard.** A FEMA National Flood Hazard Layer FIRMette shows the old building at the elevation of the 100-year floodplain, 876 ft, and the new one at the elevation of the 500-year floodplain, 880 feet. The project team constructed a flood hazard curve that related depth of flooding to mean exceedance frequency with the common assumption that the natural logarithm of mean exceedance frequency varies linearly with flood elevation. Thus, for example, flooding reaches 878 feet (2 feet above the base of the old building and below the base of the new) with a mean exceedance frequency of 0.004, that is, once every 250 years.

**Direct damage to control building equipment.** The Hazus Flood Model provides a vulnerability function for repair cost to low- and medium-voltage substation equipment. It also implies loss of function when the depth of flooding reaches 4 feet, which appears to apply to yard equipment, not the control building. It seems more reasonable to assume that the control building would become nonfunctional when initially flooded, because operators would deenergize equipment at that stage.

**Loss of use duration and costs.** Hazus offers no estimate of flood duration or loss-of-use costs. The following analysis assumes that flooding lasts one day per foot of depth, plus one day to clear and reenergize equipment or to replace damaged computers and reinstall control software. It is assumed that loss of function affects all 9,200 inhabitants of Reedsburg. Without power or telecommunications, homes are still occupied, but residents must dine out at a cost (or equivalent value) equal to the GSA's per diem rate of \$51 per day per person. Insurers commonly call these costs ALE. Without power and telecommunications, businesses do not operate at all (no telecommuting, for example), causing a direct BI loss of the Wisconsin per-capita daily GDP, \$130. Elsewhere, the project team shows that indirect BI amounts to an additional \$0.50 per \$1.00 of direct BI losses and ALE.

**Casualties.** Elsewhere in this study the project team estimated that a blackout causes deaths at a rate of 0.56 per 100,000 population per day, and nonfatal medical injuries 50 times as high. It is not clear that loss of electricity alone causes PTSD, so no PTSD benefits apply to this project.

**Historic and environmental losses.** None seem to apply.

**Benefit-cost ratio.** Considering the foregoing project-specific information presented here, the general procedures presented elsewhere in the study, a 75-year project life, and a cost-of-borrowing discount rate of 2.2%, the project produces \$2.2 million in benefit at a cost of \$235,000, for an overall BCR of \$9.40 saved per \$1.00 invested, i.e., 9 to 1. Most of the benefits are from reduced BI to the community, as shown in Figure 6-22. Using higher discount rates of 3% and 7%, the BCRs are lower, 8 and 4, respectively, but still substantially above 1.0.

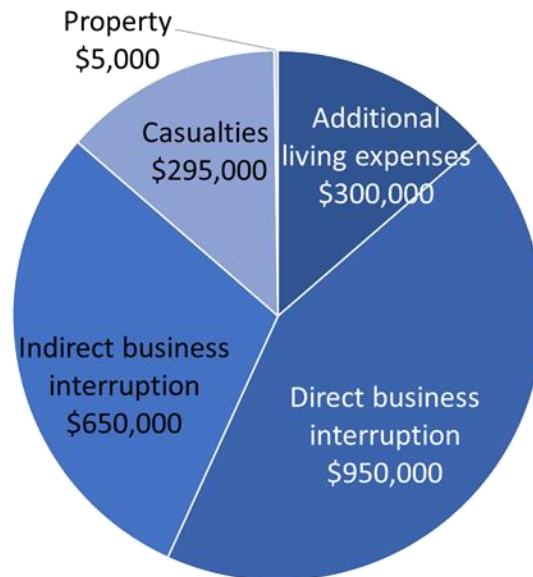

Figure 6-22: Estimated benefits from new telephone and electrical switching building in Reedsburg, Wisconsin.

### 6.2.4. Wind Mitigation for Electric and Telecommunications

EDA funded two grants that mitigated wind risk to electric and telecommunication facilities.

#### 6.2.4.1. Summary of the Grants

**Project 1:** Replacing aboveground power lines from Derby to West Charleston and Bloomfield to Canaan (both alignments in Vermont). The project description reported by EDA: i) Derby-to West Charleston – replacement of 5.25 miles of 46kV transmission lines, and ii) Bloomfield to Canaan – replacement of 26 miles of 34.5kV transmission lines with 520 poles. “The new electrical distribution system will provide more reliable electric service to the area and minimize disruptions to local business operations.”

The project team conducted online research for additional online information about the project. Vermont Electric Coop reported that the replacement of aging, single-phase electric lines with three-phase lines will also help to improve the reliability of service to small businesses and farms.

**Project 2:** Electric power line improvements to The Point, Seabrook, Texas. The project description reported by EDA: infrastructure improvements to The Point, including burying electrical power lines and other utilities in order to aid in disaster resiliency. This aid was provided by EDA in response to damage incurred during Hurricane Ike (2008). In addition to the EDA grant, the city of Seabrook also received a CDBG grant awarded by HUD but administered to the city through the state of Texas.



## 6.2.4.2. Methodology

The approach for this task consisted of the following steps: 1) utilize the online ASCE 7 Hazard Tool (ASCE 2018) to determine expected wind speeds for various mean return intervals (MRI), and in the case of the Vermont alignments, ice thickness, 2) research and select an existing wind damage model for aboveground power poles, 3) identify the exposure and inventory details of the different electric power distribution systems, i.e., confirm rural versus urban details, power pole installations (mainly distances between poles), confirm type of power pole (wooden versus metal), confirm rough power pole height details, 4) research loss estimation or loss avoidance methodologies for wind hazards, and 5) develop spreadsheet to perform loss estimates (with and without mitigation) and subsequent BCRs.

**ASCE 7 online hazard platform.** For this project, the team utilized the ASCE 7 online hazard platform to obtain wind speeds vs. mean return interval for all projects. The ASCE 7 standard that is currently being used on the platform is the ASCE/SEI 7-16 (American Society of Civil Engineers Structural Engineering Institute 2107, Fig. 26.5-1A and Figs. CC.2-2 to CC.2-4). The platform requires the following input in order to return wind speed and ice thickness data: location (latitude and longitude) and risk category. For these grants, the team used the lowest Risk Category I (buildings and other structures that represent a low hazard to human life in the event of failure).

In both sets of projects (Vermont and Texas), the geographic extent of the areas of interest were small enough where the resolution of the ASCE 7 Hazards Tool was not very sensitive to the placement of the position cursor, e.g., the same set of wind speeds and MRIs were returned for both power system alignments in Vermont.

The wind speeds pertain to 3-second gust wind speeds at 33 ft above ground for Exposure Category C. Wind speeds vs. MRI for both sets of projects (Vermont and Seagate, Texas alignments) are contained in Table 6-2. Figure 6-23 shows a plot of annual frequency versus wind speed (mph) for the Vermont power distribution alignments.

**Table 6-2:** Wind speeds versus mean recurrence intervals for Vermont and Texas alignments.

Mean recurrence interval (MRI)	Annual frequency (yr <sup>-1</sup> )	Wind speed (mph)	
		Vermont	Seagate, TX
10 years	0.1	73	78
25 years	0.04	80	96
50 years	0.02	84	110
100 years	0.01	89	121
300 years	0.003	99	134

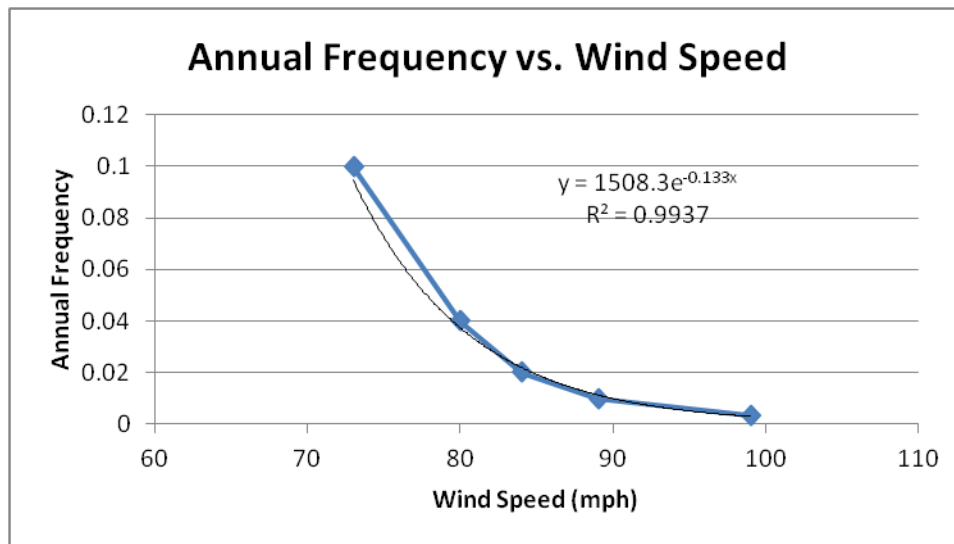

Figure 6-23: Annual Frequency versus Wind Speed (mph) for Derby-West Charleston & Bloomfield to Canaan.

For the Vermont alignments, the project team also extracted ice thickness information from the ASCE 7 Hazard Tool. Based on platform readings, the radial ice thickness value (in) is one (1) inch, which corresponds to a 50 mph, 3-second gust speed. The project team assumed that the MRI associated with this ice thickness value is 50 years.

**Wind damage function for aboveground electric power poles.** The project team reviewed three publications in order to select an appropriate damage function for aboveground power poles.

- *Fragility Curves for Assessing the Resilience of Electricity Networks Constructed from an Extensive Fault Database* (Dunn et.al., 2018).

Fragility curves are developed for overhead electrical lines using an empirical approach to model likely failures due to wind storm hazards. To generate these curves, the authors compiled a dataset of 12,000 electrical failures in the United Kingdom and correlated it with the European Reanalysis (ERA) wind storm model. The results are presented in terms of number of assets failed per km as a function of wind speed.

- *Age-Dependent Fragility Models of Utility Wood Poles in Power Distribution Networks against Extreme Wind Hazards* (Shafieezadeh et.al. 2014).

A sampling approach involving a demand and capacity model was used to generate a statistical sample of 20,000 faults that were randomly paired with wind velocity. Fragility models were generated for new wood poles, and poles that are 25, 50, 75, and 100 years old. The results are presented in the form of probabilities of failure as a function of wind velocity and ANSI pole class.

## NATURAL HAZARD MITIGATION SAVES:

- *Effects of Adjacent Spans and Correlated Failure Events on System-Level Hurricane Reliability of Power Distribution Lines* (Darestani et.al. 2017).

This paper investigates the effects of environmental conditions that may impact the decay rate of wooden power poles and ultimately the impact on system reliability. The results are presented in terms of probability of failure versus 3-second gust wind speeds for a mean pole age of 30 years.

Based on the ease of use and the dependency on pole age, the project team decided to use the Shafieezadeh et al. (2014) fragility curve for modeling wind damage to aboveground power poles. See Figure 6-24.

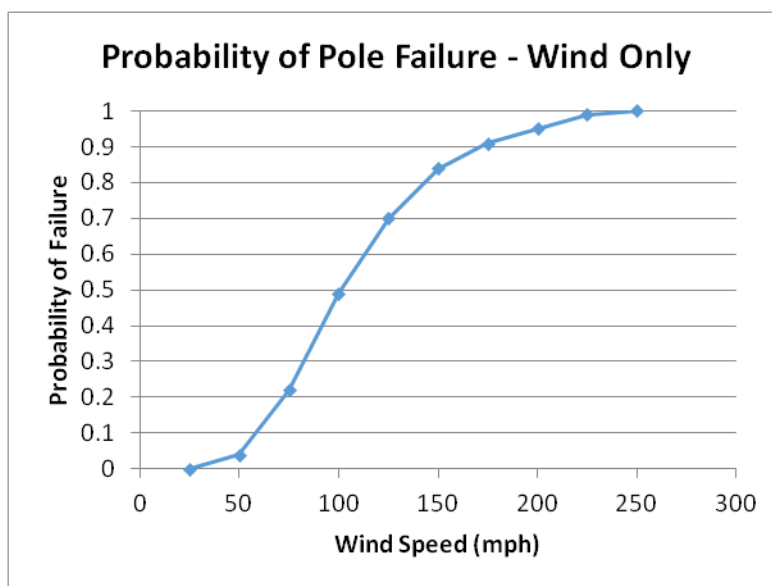

Figure 6-24: Power pole fragility model for wind effects (Shafieezadeh et al., 2014).

In order to estimate damage due to excessive ice loads, the project team used a model developed for the FEMA study, *Electrical Transmission and Distribution Mitigation: Loss Avoidance Study (2008)*. That study analyzed mitigation effectiveness of various measures as applied to power transmission and distribution lines in Nebraska and Kansas. For this effort, the project team adapted the methodology for loss avoidance presented in that study by substituting local wind hazard information and scaling some of the damage models presented in the FEMA study (more discussion below). The damage/pole failure model used in the FEMA study for ice hazards was a function of three parameters: the *National Electrical Safety Code* (NESC) (Grade N for older systems and Grade C or B for all new improvements); tree clearance (from zero: tree clearance exceeds 10 feet in all locations to three: tree clearance may be less than 10 feet at some locations, from 11 to 20 spans per miles of circuit); and radial ice index (from zero to three inches). In the FEMA report, for a condition that is associated with one inch radial ice thickness, NESC Grade N, and tree clearance index of 3, the probability of pole failure is 0.055. Based on the location of the Vermont alignments, this probability is associated with a MRI of 50 years. To scale ice thickness to different MRIs, the team used the wind speed-MRI distribution provided by the ASCE 7 Hazard Tool.

## NATURAL HAZARD MITIGATION SAVES:

*Loss avoidance calculation.* To estimate projected losses based on wind and ice load hazards, the project team adopted the methodology presented in FEMA 2008. The methodology provides a stepwise calculation procedure that begins with an initial statement of exposure (i.e., rural versus urban, number of power poles, population) and hazard levels (ASCE 7). For many of the equations, FEMA 2008 references an earlier FEMA document (FEMA 2003), especially for quantifying ice load risks. For convenience, the calculation steps are reproduced below.

**Step 1:** Number of poles damaged:  $N = \text{poles damaged} = P_f \times (\text{length of power lines in miles}) \times (\text{no. poles per mile})$

**Step 2:** Number of wires damaged:  $W = N \times 3$  (for rural) or  $N \times 6$  (for urban)

**Step 3:** Number of cross-arms damaged (pole does not require repair):  $C = N \times 0.1$

**Step 4:** Number of guy wires damaged:  $G = N \times 0.01$

**Step 5:** Number of pole-mounted transformers to be repaired:  $T = N \times 0.2$

**Step 6:** Hours by lineman in the field:  $H = N \times 8 + W \times 2 + C \times 4 + G \times 4 + T \times 2$

**Step 7:** Number of lineman available:  $L = \text{population served} \times 0.005$

**Step 8:** Estimate no. of days to complete restoration of service:  $D_{100} = H / (12 \times L)$

**Step 9:** Estimate losses based on FEMA (2003) unit costs: \$7,502 to repair damaged pole & \$220 per person per day of lost service (costs have been scaled to 2018 costs)

### 6.2.4.3. Exposure or Inventory Information

Vermont alignments:

Derby to West Charleston:

- Total population at risk: 5,254
  - Derby 4,613 (population) - Source: 2010 Census
  - W. Charleston 641 (population) – Source: 2010 Census
- Miles of line 5.25 miles (source: EDA report)
- No. of poles/mile 18 (default for rural areas) – Source: Federal Emergency Management Agency (2003, 2008)

Bloomfield to Canaan:

- Total population at risk (source: 2010 Census): 3,680
  - Canaan 972
  - West Stewartstown 386
  - Colebrook 1,394

## NATURAL HAZARD MITIGATION SAVES:

- Lemington            104
- Columbia            603
- Bloomfield           221
- Miles of line                26 miles (source: EDA report)
- No. of poles/mile            20 (source: EDA report)

### Seabrook, TX Alignments:

- Total population at risk: 11,952 (source: 2010 Census)
- Power pole is a Class 5 (more narrow pole) and around 75 years old based on age of Seabrook (roughly 60 years)
- Amount of power lines buried equal to the length of streets that are being renovated under the EDA grant (1,950 feet)
- Assume Risk Level 1 for power poles – lowest implemented
- Distance between poles is 80 feet based on measuring separation in several Google Street Views and Google Maps of the Point.
- 66 poles in one mile

#### 6.2.4.4. Results for Vermont Alignments

To determine the total benefit of these pole replacements, the project team calculated, on an annualized basis, the avoided losses from wind and ice damage for both projects. This section presents the intermediate and final results from this analysis.

##### *Project 1: Vermont alignments*

Based on the EDA data, the project team assumed aboveground power line replacements from i) Derby-West Charleston – replacement of 5.25 miles of 46kV transmission lines, and ii) Bloomfield to Canaan – replacement of 26 miles of 34.5 kV transmission lines with 520 poles.

##### i) Derby-West Charleston

Table 6-3 contains the mean pole failure probability (Pf) from wind and ice damage as a function of wind speed. The table contains both the conditional probability of failure and the probability of failure weighted by wind speed probability,  $P_f = P_{f|WS} \times P_{WS}$ , that is where WS is wind speed (mph).

**Table 6-3:** Pole failure probabilities (Derby to West Charleston alignment).

Wind speed (mph)	$P_{f WS}$	$P_{WS}$	$P_f$
10	0.024	-	-
30	0.073	-	-
50	0.122	0.484	0.059
70	0.170	0.480	0.082
90	0.219	0.034	0.007

After calculating the pole failure probability, the project team followed the procedure presented above to produce an annual loss estimate. The calculation process begins by first estimating the total number of damaged components (N). Table 6-4 lists the values at each step of the calculation for the Derby to West-Charleston power distribution alignment.

**Table 6-4:** Damaged (Derby to West Charleston alignment).

Wind speed (mph)	Damage parameters						
	$P_f$	N	W	C	G	T	H
10	-	-	-	-	-	-	-
30	-	-	-	-	-	-	-
50	0.059	5.563	16.688	0.556	0.056	1.113	82.55
70	0.082	7.728	23.184	0.773	0.077	1.546	114.68
90	0.007	0.695	2.085	0.070	0.007	0.139	10.31

The number of linemen available to work on repairs is estimated next in Step 7. Based on the total population at risk for the service area (5,254), the total number of linemen available for repairs is  $5,254 \times 0.005 = 26$ .

Table 6-5 shows the number of days until 100% service is restored ( $D_{100}$ ). The FEMA (2008) methodology assumes that in these emergency repair situations, linemen will work shifts of 12 hours per day, 7 days per week until all service is restored.

**Table 6-5:** Days to full service restoration (Derby to West Charleston alignment).

Wind speed (mph)	$D_{100}$ (days)
10	-
30	-
50	0.26
70	0.36
90	0.03

## NATURAL HAZARD MITIGATION SAVES:

The expected loss based on pole damage/failure is the sum of the total repair cost plus the cost that is incurred because of power disruption. As indicated in Table 6-3, \$7,502 is used to reflect the cost to repair a damaged pole and \$220 per person per day is assumed to cover loss of service. Both numbers have been scaled up to 2018 to reflect inflation increases. Table 6-6 lists each loss type by wind speed. The sum of all losses over all wind speeds is the expected annualized loss (EAL) for the project.

**Table 6-6:** EAL from wind and ice damage to poles (Derby to West Charleston alignment).

Wind speed (mh)	Physical damage (\$)	Loss of function (\$)	Loss (\$)
10	-	-	-
30	-	-	-
50	41,731	372,849	414,580
70	57,976	517,989	575,964
90	5,214	46,584	51,798
Expected annualized loss	104,921	937,422	1,042,343

ii) Bloomfield to Canaan

Table 6-7 presents the mean pole failure probability (wind and ice hazards) for power lines between Bloomfield and Canaan.

**Table 6-7:** Pole failure probabilities (Bloomfield to Canaan alignment).

Wind speed (mph)	$P_{f WS}$	$P_{WS}$	$P_f$
10	0.0110	-	-
30	0.0330	-	-
50	0.0550	0.5462	0.0300
70	0.0770	0.4194	0.0323
90	0.0990	0.0318	0.0031

Table 6-8 shows the damage calculation values for the Bloomfield to Canaan alignment. Because of the longer length of this alignment compared to Derby to West Charleston line, the damage calculation values are higher by a factor of at least two.

The total number of linemen available for repairs, based on a population of 3,680, is estimated at Number of linemen:  $3,680 \times 0.005 = 18.4$

Table 6-9 presents the total number of days until 100% of service is restored. Table 6-10 provides the total EAL.

Table 6-8: Damage (Bloomfield to Canaan alignment).

Wind speed (mph)	Damage parameters						
	P <sub>f</sub>	N	W	C	G	T	H
10	-	-	-	-	-	-	-
30	-	-	-	-	-	-	-
50	0.030	15.622	46.866	1.562	0.156	3.124	231.83
70	0.032	16.793	50.378	1.679	0.168	3.359	249.20
90	0.003	1.636	4.908	0.164	0.016	0.327	24.28

Table 6-9: Number of days to full service restoration (Bloomfield to Canaan alignment).

Wind speed (mph)	D <sub>100</sub> (days)
10	-
30	-
50	1.05
70	1.13
90	0.11

Table 6-10: EAL due to wind and ice damage to poles (Bloomfield to Canaan alignment).

Wind speed (mph)	Physical damage (\$)	Loss of function (\$)	Total loss (\$)
10	-	-	-
30	-	-	-
50	117,196	1,047,094	1,164,290
70	125,978	1,125,561	1,251,539
90	12,273	109,656	121,930
Expected annualized loss	255,447	2,282,312	2,537,759

Table 6-11 Lists the total EAL for Project 1 (Derby to West Charleston and Bloomfield to Canaan).

Table 6-11: Total EAL for Project 1 by loss type.

Community	Physical damage (\$)	Loss of function (\$)	Total (\$)
Canaan to Bloomfield	255,447	2,282,312	2,537,759
Derby to West Charleston	104,921	937,422	1,042,343
Expected annualized loss	360,367	3,219,735	3,580,102

**Benefit-cost ratios.** Table 6-12 presents the BCR for Project 1 (undergrounding Vermont alignments) for four different time horizons (25, 50, 75 and 100 years). The assumption here is that relocating power lines



## NATURAL HAZARD MITIGATION SAVES:

below ground will eliminate any wind or ice load hazards, and thus, the calculated annual losses will be zero. This analysis did not consider any new hazards that may affect the lines while buried, e.g., land movement, flooding, construction, etc. The project team used a discount rate of 2.2% in this analysis to discount future benefits (the rate used for other projects in the overall study). Therefore, the benefit presented in table are the losses avoided over the specified time period or horizon. The table presents the BCR by time horizon, based on the benefits calculated and the original project cost (extracted from the EDA grant information), which is \$17,228,894.

**Table 6-12:** BCRs for undergrounding Vermont alignments, by time horizon.

Time horizon	Benefit	BCR
25 years	\$71,862,364	4.17
50 years	\$111,493,407	6.47
75 years	\$134,495,275	7.81
100 years	\$147,439,304	8.56

### 6.2.4.5. Results for Seabrook, Texas Alignment

The Texas project involved infrastructure improvements at The Point in Seabrook, Texas, including the burial of electrical power lines and other utilities in order to aid in disaster resiliency. Table 6-13 presents the pole failure probabilities (mainly from wind effects).

**Table 6-13:** Pole failure probabilities (Seabrook, Texas alignment).

Wind speed (mph)	$P_{f WS}$	$P_{WS}$	$P_f$
25	0	-	-
50	0.04	0.712	0.028
75	0.22	0.222	0.049
100	0.49	0.051	0.025
125	0.7	0.012	0.008
150	0.84	0.003	0.002
175	0.91	0.001	0.001
200	0.95	1.4E-04	1.3E-04
225	0.99	3.2E-05	3.2E-05
250	1	7.3E-06	7.3E-06

Table 6-14 contains the damage calculated using the steps outlined in Section 6.2.4.2. Since the wind hazard is more significant in this area, the range of possible wind speeds and their probabilities of occurrence (and the impact on the damage parameters) is much broader than in the Vermont case.

**Table 6-14:** Damage (Seabrook, Texas alignment).

Wind speed (mph)	Damage parameters						
	P <sub>f</sub>	N	W	C	G	T	H
25	-	-	-	-	-	-	-
50	0.028	0.694	2.082	0.069	0.007	0.139	10.30
75	0.049	1.192	3.576	0.119	0.012	0.238	17.69
100	0.025	0.607	1.822	0.061	0.006	0.121	9.01
125	0.008	0.199	0.596	0.020	0.002	0.040	2.95
150	0.002	0.054	0.163	0.005	0.001	0.011	0.81
175	0.001	0.014	0.041	0.001	1.4E-04	0.003	0.20
200	1.3E-04	0.003	0.010	3.2E-04	3.2E-05	0.001	0.05
225	3.2E-05	0.001	0.002	7.7E-05	7.7E-06	1.5E-04	0.01

Based on a total population at risk of 11,952, the number of linemen available to participate in the repair effort is estimated as  $11,952 \times 0.005 = 59.76$ .

Table 6-15 shows the number of days required to completely restore service ( $D_{100}$ ) for different wind speeds. As in the Vermont case, the project team assumed that linemen will work 12 hours per day, 7 days per week until all service is restored.

**Table 6-15:** Days to full restoration (Seabrook, Texas alignment).

Wind speed (mph)	$D_{100}$ (days)
25	-
50	0.014
75	0.025
100	0.013
125	0.004
150	0.001
175	2.8E-04
200	6.7E-05
225	1.6E-05

Using the same unit cost values as in the Vermont case, Table 6-16 lists the EAL by type and by wind speed.

**Table 6-16:** EALs from wind damage to poles (Seabrook, Texas alignment).

Wind speed (mph)	Physical damage (\$)	Loss of function (\$)	Total loss (\$)
25	-	-	-
50	5,206	46,512	51,718
75	8,943	79,899	88,842
100	4,557	40,713	45,270
125	1,489	13,306	14,795
150	409	3,653	4,062
175	101	905	1,007
200	24	216	240
225	6	52	57
Expected annualized loss	20,735	185,256	205,991

*Benefit-cost ratios.* Table 6-17 presents the total benefits and BCR for each time horizon. A 2.2% discount rate has been assumed; the total project cost (as recorded by the EDA grant package) is \$3,668,691.

**Table 6-17:** BCRs for undergrounding by time horizon (Seabrook, Texas alignment).

Time horizon	Benefit (\$)	BCR
25 years	4,134,794	4.13
50 years	6,415,072	6.41
75 years	7,738,546	7.73
100 years	8,483,315	8.47

**6.2.4.6. Conclusions and Limitations**

The calculations of future benefits over varying time horizons suggest that the mitigation measures undertaken in the EDA projects (i.e., burying electric power distribution lines) are highly cost effective even for short time horizons (25 years). That is, the ROI (in the form of avoided losses) is highly likely given the measures that have been taken and the projected risks of hazard occurrence.

In this study, the project team did not explore new risks that may have emerged as a result of burying these distribution lines. For example, there may be new risks from local flooding, land movement caused by settlement or landslides, or construction accidents. However, it is assumed that any of these new risks would be significantly smaller than those that have been mitigated (wind and ice) and therefore, would be negligible.

## 6.3. BENEFIT-COST ANALYSIS OF RESILIENT WATER SUPPLY GRID

### 6.3.1. Introduction

As part of its research, the project team examined the benefits and costs of implementing a resilient grid in an urban water supply network; that is, whether it is cost effective to improve network resilience by reducing the vulnerability or otherwise improving all or some trunk lines, thereby forming a *resilient grid* (Davis 2017). Specifically, the project team assume the stress event affecting the network would be an earthquake. Figure 6-25 shows a schematic network. The figure shows that a transmission line brings raw water from the source (in the figure, a reservoir) to a treatment plant. Treated water is conveyed to terminal reservoirs and then the distribution network. Within the distribution network, trunk lines convey water to distribution lines. Some or all of the trunk lines can form the resilient grid. In most U.S. cities, the distribution piping often has diameters of 6 or 8 inches. Trunk lines typically have diameters between 12 and 24 inches. Because of topography and other geographic features, as well as historical development, water distribution networks in actual cities each have their own peculiarities. To draw general conclusions for cities in high seismic hazard locations therefore, rather than examining a particular, real system, the project team examined an idealized water supply network that seems generally representative of a medium-sized U.S. city.

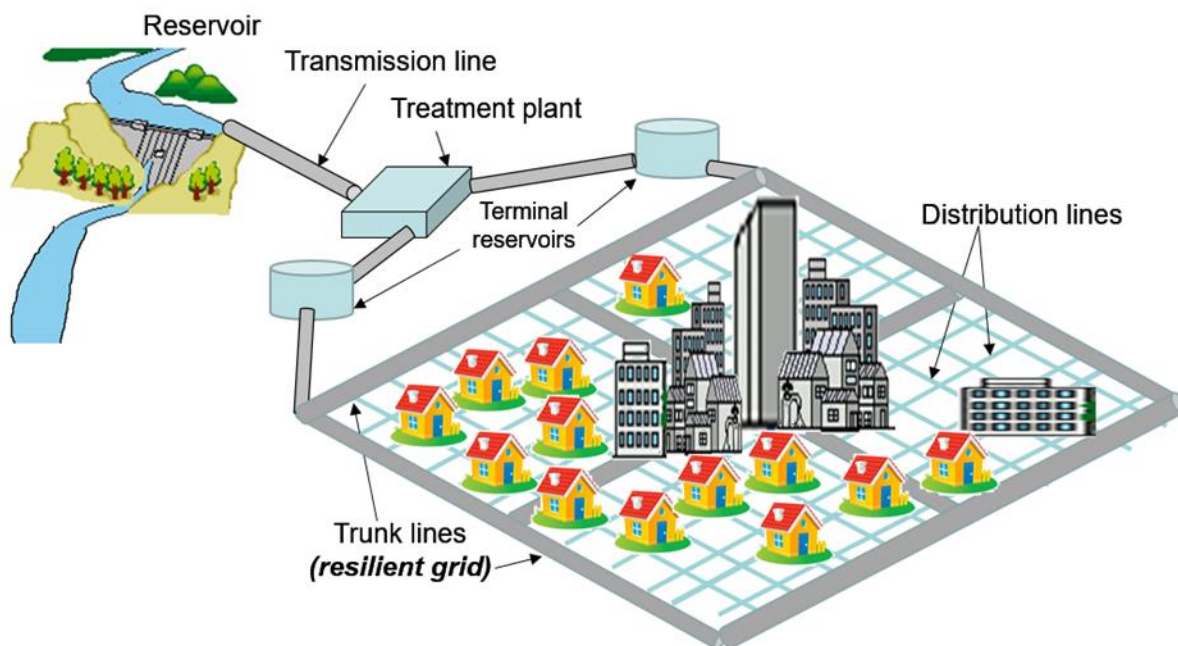

Figure 6-25: Schematic of water supply network.

## NATURAL HAZARD MITIGATION SAVES:

The project team used a three-phased approach for this study:

1. In Phase 1, the team examined various configurations of distribution and trunk lines to arrive at a water supply network or grid representative of a medium-sized U.S. city (the study region). The region is supplied from a water source outside the region via two transmission lines supplying two terminal reservoirs, a grid of larger trunk lines, and a network of smaller distribution pipes. The region is square-symmetric to eliminate bottlenecks or other complicating factors. The size and spacing of distribution pipes and trunk lines will be selected so as to provide typical average day demands, including ordinary fire flows. The ordinary fire flows are two 5,000 gpm demands. The project team termed this network the *as-is network*.
2. In Phase 2, the project team stressed the as-is network with random breaks and leaks resulting from earthquake excitation, together with extraordinary fire demands associated with the phenomenon of fire following earthquake. (Other natural hazards can also increase demand on a water supply system. Tsunamis, for example, can also ignite fires and increase demands for firefighting water supply. Under earthquake excitation, the as-is system can experience damage-associated costs of repairs as well as a shortfall of supply; that is, insufficient water pressure to continue serving all its customers and to provide firefighting water supply. The shortfall results because the system was not designed with such disasters in mind. This shortfall then has consequences in terms of loss of service, leading to larger fires and time to recovery.
3. In Phase 3, the project team improved the as-is system to form a resilient grid. The improvement consists of replacing trunk lines (only) with lower vulnerability pipe; that is, pipe that experiences less damage when subjected to earthquake excitation. For example, one might replace cast iron or asbestos cement trunk lines with Earthquake Resistant Ductile Iron Pipe (ERDIP). The project team then determined the shortfall and resulting consequences of this resilient grid system, stressed with the same scenario, and compared them with those of the as-is system.

The difference in loss of service, fire size, time to recovery, and costs between the as-is and resilient grids is a measure of the benefit of the resilient grid. Benefits include reduced losses in several categories:

- Water-system repair costs
- Fire-related property losses
- Direct BI associated with loss of water service and fire damage
- Indirect BI losses to the rest of the economy that does business with customers who lose water service or suffer fire damage
- Deaths, injuries, and instances of PTSD resulting from fire following earthquake

The project team converted the benefits to equivalent dollar amounts. In the case of deaths, nonfatal injuries, and PTSD, dollar amounts are assigned as in the *Mitigation Saves 2017 Interim Report*.

Note that the benefits shown are not exhaustive. They are the ones that can be readily quantified and monetized. Mitigation produces other intangible benefits that are not considered here, such as prevention of loss of heirlooms, pets, etc.

## NATURAL HAZARD MITIGATION SAVES:

The project team estimated the benefit per year by integrating benefits with frequency of hazard. The team estimated the present value of benefits over a time horizon by applying a discount rate equal to the real cost of borrowing. The present value of benefits divided by cost is the BCR for the resilient grid.

### 6.3.2. Analytical Method

#### 6.3.2.1. Selecting a Characteristic Study Region

To develop a study region representative of a medium-sized U.S. city, the project team compiled data for all U.S. cities with 2016 (est.) populations greater than 100,000, as shown in Figure 6-26, which encompass a total population of 93 million. Because of the decreasing ratio of repair resources with increasingly larger populations, the issue of resilient grids is more important the larger the city. Therefore, the initial focus of this study is on larger cities. For this purpose, the project team examined the 50 largest cities, as shown in Figure 6-27, which encompass a total population of 50 million. The mean population of these 50 largest cities is 998,000 and the median population 646,000, so a study area with population on the order of three quarters of a million persons was deemed representative of large U.S. cities.

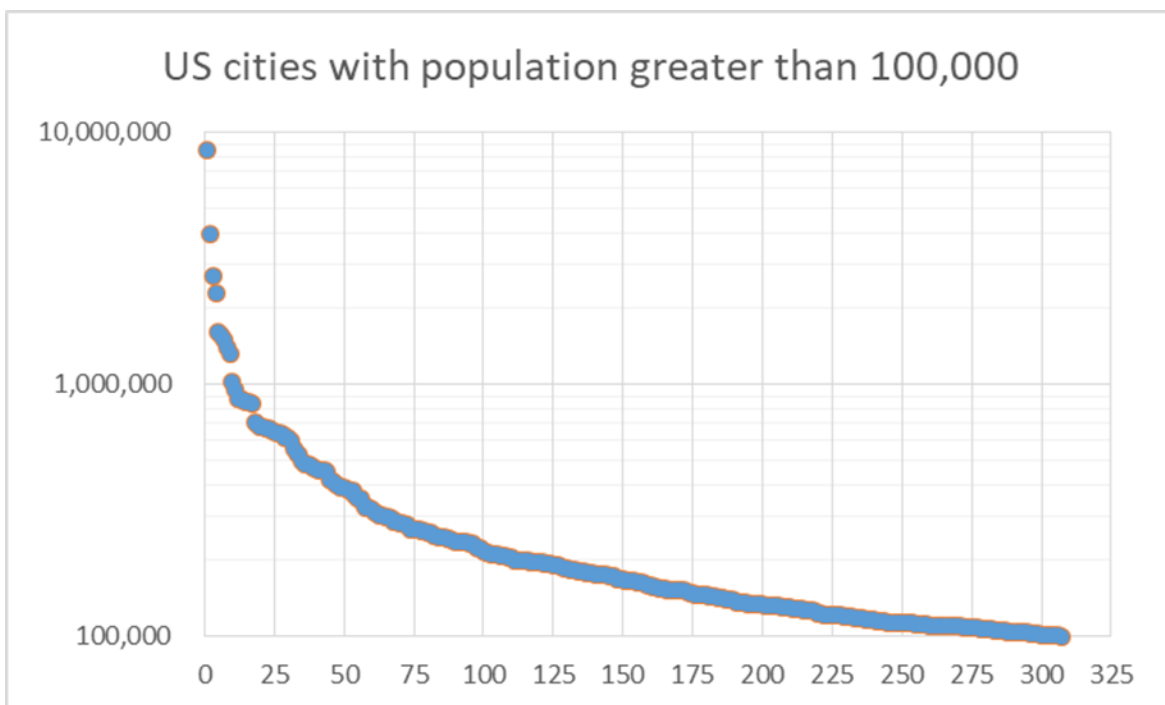

Figure 6-26: Frequency plot of U.S. cities with population greater than 100,000.

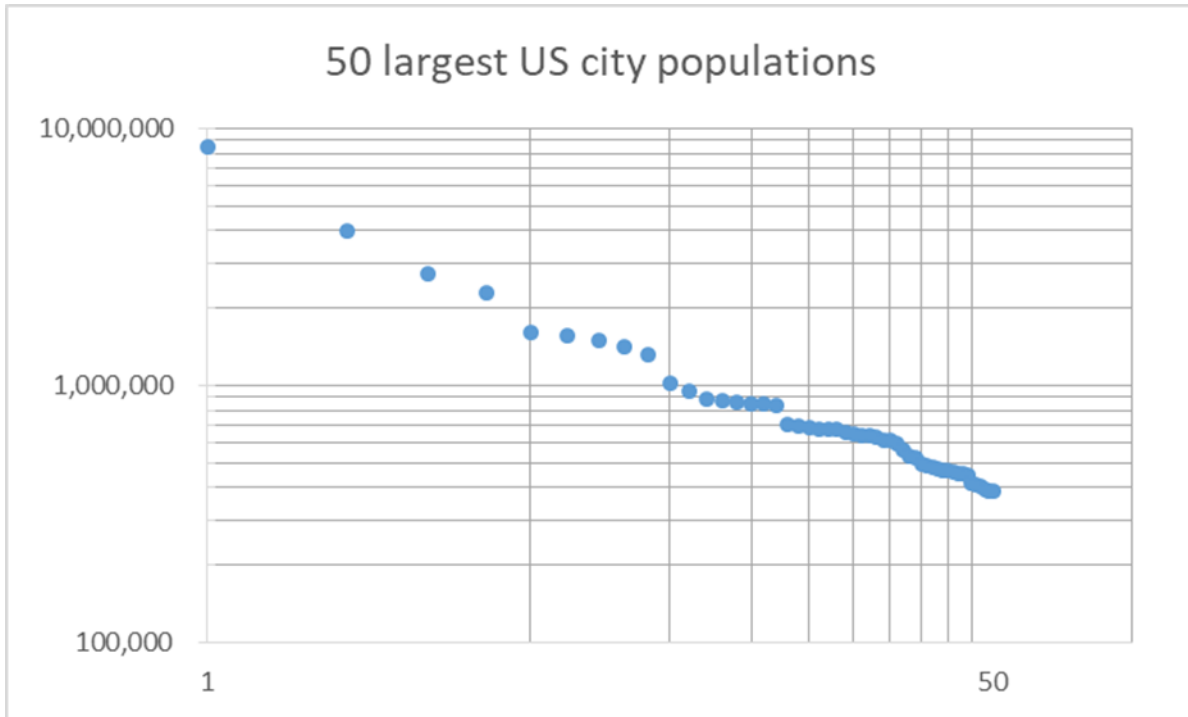

Figure 6-27: Distribution of 50 largest U.S. city populations, mean (998,000) and median (646,000).

### 6.3.2.2. Initial Configuration

The project team selected a square grid  $b \times b$  blocks, each block being  $L$  (ft.) square, as shown in Figure 6-28, as representative of a city of about 750,000 population. The study grid is intended to be representative of the distribution system of a medium-sized city. The grid consists of  $b + 1$  lines of north-south and  $b + 1$  lines of east-west distribution pipes regularly spaced at  $L$  (depicted as gray lines). Specific values were  $b = 60$  and  $L = 600$  feet. The grid consists of 61 lines of north-south and 61 lines of east-west distribution pipes regularly spaced at  $L$  (depicted as gray lines), so that the grid is 36,000 ft (6.82 miles) on a side. Trunk lines of the resilient grid are placed every  $n$  distribution pipes (depicted by bold blue lines in the figure as every 5th distribution pipe, or a grid of 3000 ft). The source is to the south of the grid, which supplies two terminal reservoirs placed symmetrically in the east and west parts of the city via transmission lines (in red – the transmission lines are not part of the model). The distribution grid is not connected to the trunk grid except at intersections of the trunk grid. All parameters are listed in Table 6-18.

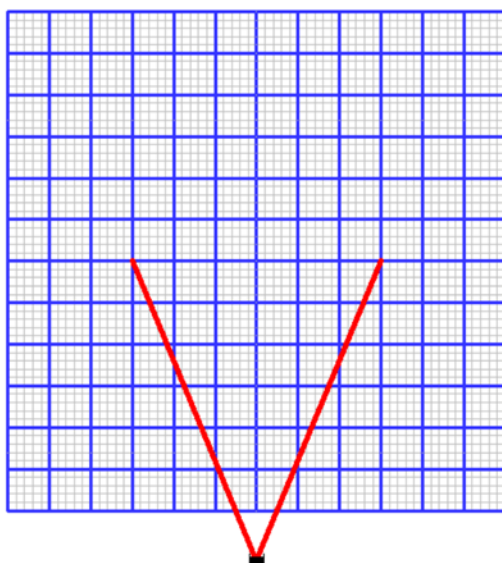

Figure 6-28: Study grid.

Table 6-18: Parameters and acronyms used in the study and their values.

Symbol	Parameter	Value
$A_{cont}$	Additional replacement value for contents	50%
$B$	No. of blocks	60
$B_{pa}$	Benefits per annum	To be solved for
$BCR$	Benefit-cost ratio	To be solved for
$B_{LF}$	Buildings per large fire	312.5 (derived)
$C$	Per capita water consumption (gallons per day)	90
$C$	Project cost per inch-diam. per ft. of installed pipe	\$50
$C_{bldg}$	Replacement cost for buildings	\$200 per sq. ft.
$C_{cust}$	Cost to customers	To be solved for
$C_{HI}$	Value lost or cost of human injury	To be solved for
$C_{los}$	Cost of loss of service per day per service connection	\$720
$C_{morb}$	Value lost due to an injury	\$0.55 million
$C_{mort}$	Value lost due to a fatality	\$9.4 million
$C_{prop}$	Replacement cost for buildings and contents	A variable
$C_{PTSDpc}$	Value lost or cost of PTSD, per person	\$33,750
$C_{PTSDpLF}$	Value lost or cost of PTSD, per large fire	To be solved for
$C_r$	Cost of labor for repairs (dollars per hour per worker)	\$100 per hour
$C_{rep}$	Cost of repairs	$= C_{utility} + C_{cust}$



## NATURAL HAZARD MITIGATION SAVES:

Symbol	Parameter	Value
$C_{rep/hr}$	Cost of repair per hour	$= F_{repMats} \times C_{repLabor}$
$C_{repLabor}$	Labor cost per hour for repairs, 4 pers. crew	\$400
$C_{utility}$	Cost to utility	To be solved for
$d$	Distribution pipe diameter (inches)	Varied; $d = 6''$ finally employed
$D_c$	No. of days required to complete all repairs	To be solved for
EOD	Equivalent orifice diameter	$EOD = d \times (0.5d^{-0.155})$
$FD$	Normal fire demand on the system (gpm)	10,000
$FFi$	Fire flow initial (gpm)	3,000
$f_{morb}$	Nonfatal injuries per million dollars of property loss	1.73
$f_{mort}$	Fatalities per million dollars of property loss	0.36
$F_{repMats}$	Factor on labor for materials and equipment	30%
$h$	No. of households (HH) per block	62.5
$H_{day}$	No. of hours per day worked by crews	12
$Igns$	Number of ignitions	A variable
$K_1$	A factor to account for pipe material	Varies by material
$L$	Length of a block (ft.)	600
$MMI$	Modified Mercalli Intensity	VI~IX (denoted 6~9)
$n$	Interval of trunk lines vis-à-vis distribution lines	Varied; $n = 10$ finally employed
$N_{dr}$	No. of distribution repairs	To be solved for
$N_{dr}$	Total number of repairs to distribution pipe	To be solved for
$NFE$	Number of fire engines = $f(P)$	45
$N_{tr}$	No. of trunk line repairs	To be solved for
$N_{tr}$	Total number of repairs to trunk lines	To be solved for
$p$	No. of persons per HH	3.5
$P$	Residential population in thousands	787,500
$PGA$	Peak ground acceleration (g)	A variable
$PGD$	Permanent ground deformation	A variable
$P_{LF}$	Population per large fire	1,084 (derived)
$PTSD$	Post-traumatic stress disorder	An acronym
$PV(B)$	Present value of all future benefits	To be solved for
$R_d$	Crew-hours for distribution line repair	7.6
$RR$	Repair rate	A variable

## NATURAL HAZARD MITIGATION SAVES:

Symbol	Parameter	Value
$R_t$	Crew-hours for trunk line repair	16.1
$T_{crew}$	Total no. of repair crews employed by a system	$B^2h/10,000$
$TFA$	Total floor area (sq. ft.)	504 million
$TFA_{LF}$	Total floor area per large fire, sq. ft.	700,000 sq. ft. (derived)
$TFA_{pc}$	Average total floor area per capita (sq. ft. pc)	640
$T_{ma}$	Mutual aid crew increase per day	20%
$T_{max}$	Upper limit of $(1+ T_{ma})^{Dc}$	2
WP	Wave propagation	An acronym
$Z$	Reservoir head above grid (ft.)	300

Trunk lines are placed every  $n$  distribution pipes (depicted by bold blue lines in the figure as  $n = 5$  or every fifth distribution pipe, or a trunk grid of 3000 ft). The source is to the south of the grid and supplies two terminal reservoirs placed symmetrically in the east and west parts of the city via transmission lines (shown in red, the transmission lines' vulnerability is considered in the model). The distribution grid is connected to the trunk grid only at intersections of the trunk grid. Both grids are assumed to be at 0 feet elevation connected to the terminal reservoirs at  $Z$  (feet.) elevation with negligible head loss from each reservoir to the connection to the trunk line intersection. That is, an unlimited amount of water is delivered at two locations to the trunk and distribution grids, at a head of  $Z = 300$  feet, equivalent to 130 psi pressure, prior to any frictional losses.

Each block has  $h$  households (HH) with one service connection per household) and  $p=3.5$  persons per HH<sup>29</sup>, so that there are  $b^2h = 225,000$  service connections for a total population of  $b^2hp = 787,500$ , a value which is between the median and mean of the 50 largest U.S. cities. Based on data shown in Figure 6-29 for 2005-2010 for selected U.S. cities (Kenny and Juracek 2012), a value of  $c = 90$  gallons per day per capita (gpd pc) for domestic water use was employed in this study.

<sup>29</sup> The 2017 US national average population per household is 2.77 (<https://www.census.gov/quickfacts/fact/table/US/PST045217>). The value of 3.5 reflects urban daytime population—see McKenzie et al (2010).

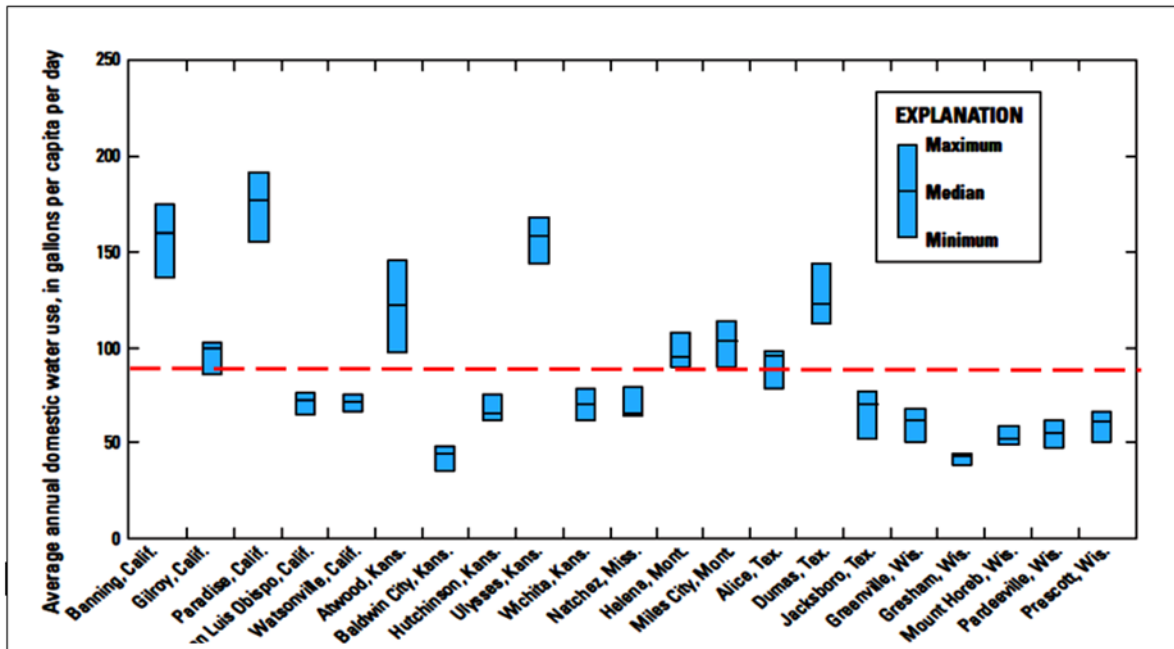

Figure 6-29: Data on 2005-2010 domestic water use for selected U.S. cities.

The as-is network then consists of two grids: (a) the distribution grid of fixed spacing  $b_L$  and a diameter to be determined in Phase 1, and (b) the trunk line grid whose diameter and spacing is also determined in Phase 1. The pipe material in the as-is grid is assumed 50% cast iron and 50% ductile iron. The distribution and trunk line grids are hydraulically connected at all of their respective intersections, and the two grids at each trunk line intersection.

### 6.3.2.3. Hydraulic Analysis and Sizing

The network (i.e., the two interconnected sub-grids) was hydraulically modeled using EPANET (Rossman 2000) in a pressure driven analysis (PDA) mode, with one demand per one node for each block; that is, the target demand per block is  $h \times p \times c = 16,399 \text{ gpd} = 13.67 \text{ gpm}$  per node/block, with a target nodal pressure of 70 psi and a minimum acceptable pressure of 20 psi.<sup>30</sup> Thus, the total target service connection demands on the system are  $h \times p \times c \times b^2 = 13.67 \times 3600 = 49,212 \text{ gpm} = 70.865 \text{ million gallons per day (mgd)}$ . Added to this is a normal fire demand  $FD$  consisting of two fires each requiring 5,000 gpm or a total of 10,000 gpm. Thus, the total demand on the as-is system is 59,212 gpm.

There are an infinite number of ways to configure the two grids to meet these targets. System design is usually accomplished as a cost minimization problem subject to constraints of acceptable flow and

<sup>30</sup> The values of 20 and 70 psi were determined based on discussions with several system operators. The lower value is the minimum acceptable pressure for firefighting water supply, and the higher acceptable value the maximum pressure in mains supplying residences – a somewhat lower value (40~60 psi) may be more typical, but the higher value of 70 psi was employed knowing that the system would be subjected to numerous leaks.

pressure and practical considerations such as that distribution pipes are typically 6 inches or 8 inches in diameter and trunk lines are 12 inches to 16 inches in diameter.

Cost  $C$  was treated here as project cost per inch-diameter per foot of installed pipe<sup>31</sup> including all valves, hydrants and other appurtenances. Project cost means all engineering, overhead, contingency and other costs are included. Costs for installation of new ductile iron water supply pipe mains vary dramatically, because of factors such as the size of the project; whether the pipe is being installed in a new development or is replacing existing pipe already in service; regional variations in labor costs; the constraints imposed by season and weather; costs associated with rerouting traffic; joint type; overhead burden; and many other factors. Discussions with system operators in California and a review of recent cost data from Arkansas, Ohio, and North Carolina found a range of costs of \$10 to \$100 per inch-foot, with so-called soft costs such as engineering and project management ranging from 30% to extremes of 100%. Given this wide variation, this study employed an installed pipe cost of  $C = \$50$  per inch-foot. If a reader feels that a cost difference is more appropriate for a specific application (\$20 per inch-foot) the costs can simply be multiplied by the ratio (i.e., 0.4).

#### 6.3.2.4. As-is Design and Validation

Given the above parameters, a least-cost network configuration can be determined. The project team started with Case 1, which consisted of all distribution pipes being 6 inches in diameter and no trunk lines, as shown in Figure 6-30. Using  $C = \$50$  per inch-foot, this proposed system has a replacement value of  $2dbLC(b+1) = \$1.32$  billion (this is the total of the costs of installing the distribution grid and the trunk line grid, in this case the latter being zero). However, hydraulic analysis shows this configuration is unable to furnish adequate pressure virtually anywhere, and is rejected.

---

<sup>31</sup> "per inch-ft." is a common rule of thumb for estimating installed pipe cost. If the cost is \$10 per inch-foot, then an 8-inch pipe costs \$80 per foot installed, and a 20-inch pipe \$200 per foot installed.

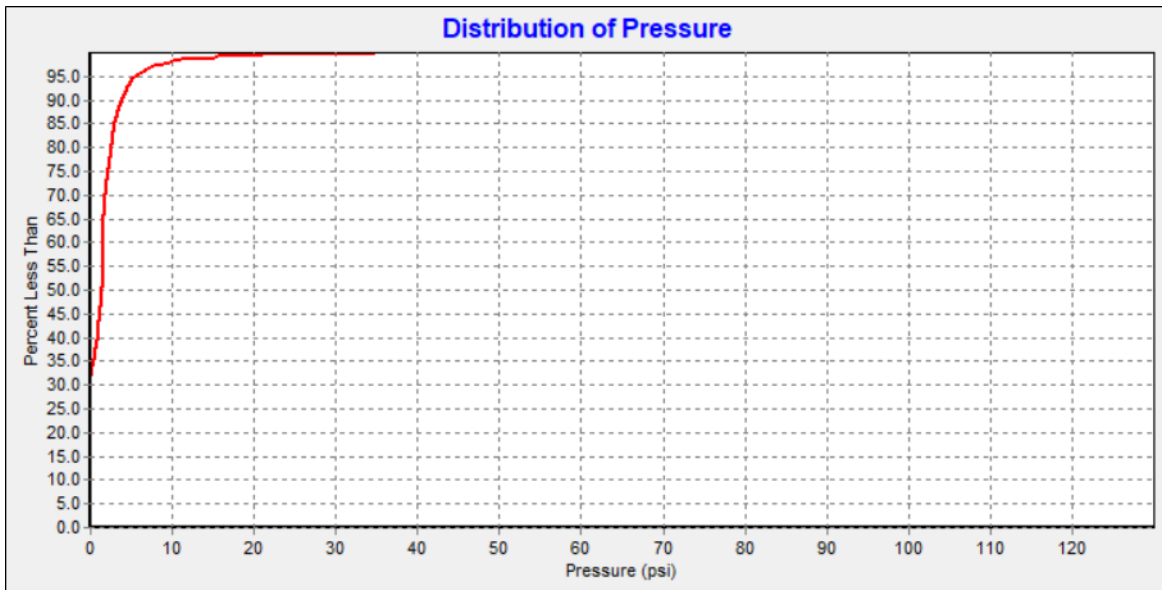

Note: (top-left) 6-inch distribution pipe, no trunk lines, two red nodes are the 5000 gpm fire demands;  
 (top right) resulting pressure distribution, gray - less than 30 psi everywhere. Total cost = \$1.32 billion.  
 (bottom) Frequency distribution of nodal pressures, from which it can be seen that almost 100% of nodes  
 have less than 30 psi pressure, with a median nodal pressure ( $P_n$ ) of about 2 psi, which is  
 unacceptable.

Figure 6-30: Water network Case 1: first round of initial design.

Cases 2 through 9 are shown in Figure 6-31 through Figure 6-38 and are summarized in Table 6-19, from which it can be seen that Case 5, consisting of a distribution grid of 6-inch diameter pipe with a trunk line grid of 16-inch pipe every tenth distribution pipe is the least cost solution (at \$1.72 billion) that satisfies the target goals with a median nodal pressure of 55 psi (with  $2 \times 5,000$  gpm fire flows) and 73 psi (no fire flows, Case 5A shown in Figure 6-38). Case 5 has a total of 4.9 million ft. of pipe (927 miles), consisting of 4.39 million ft. (831 miles, 89.7% of all lengths) of 6-inch distribution pipe and 504,000 ft. (96 miles, 10.3%) of 16-inch trunk line pipe. This as-is system has a replacement value of \$1.32 billion for the distribution system and \$403 million for the trunk line system, or a total of \$1.72 billion.

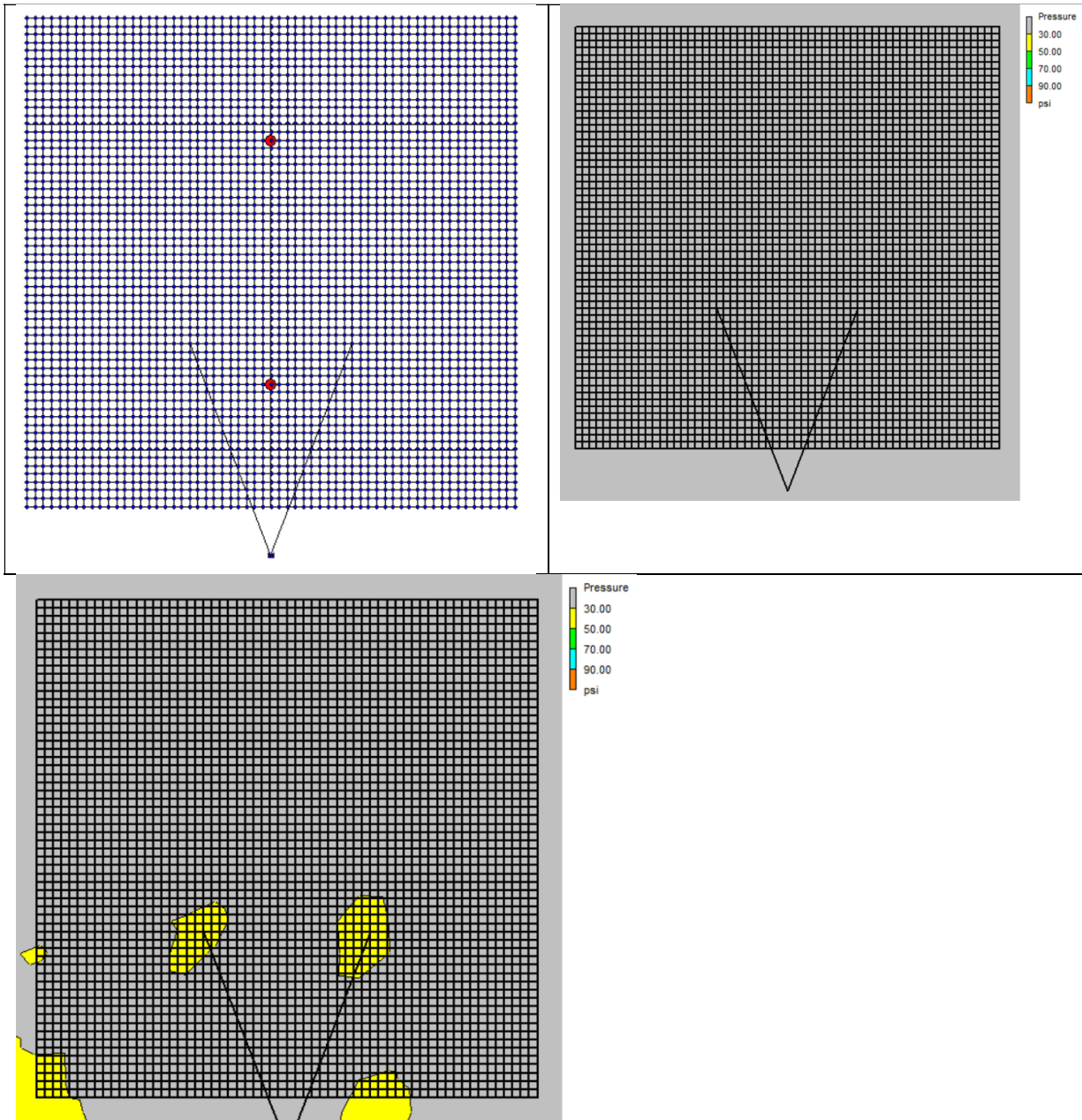

Note: 6-inch distribution, 16-inch trunk lines every 20th distribution pipe; resulting pressure distribution, less than 30 psi almost everywhere. Total cost = \$1.65 billion, but unacceptable due to inadequate pressures.

Figure 6-31: Water network Case 2: second round of initial design.

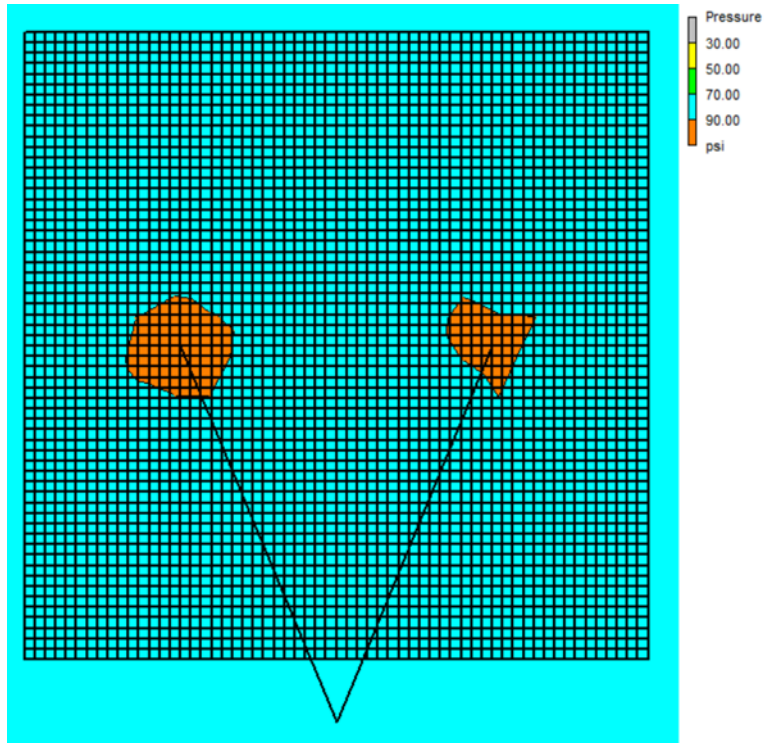

Note: 6-inch distribution pipe, 16-inch trunk lines every 5th distribution pipe; pressure distribution adequate everywhere. Total cost = \$2.07 billion.  $\bar{P}_n = 83$  psi, which is acceptable.

Figure 6-32: Water network Case 3.

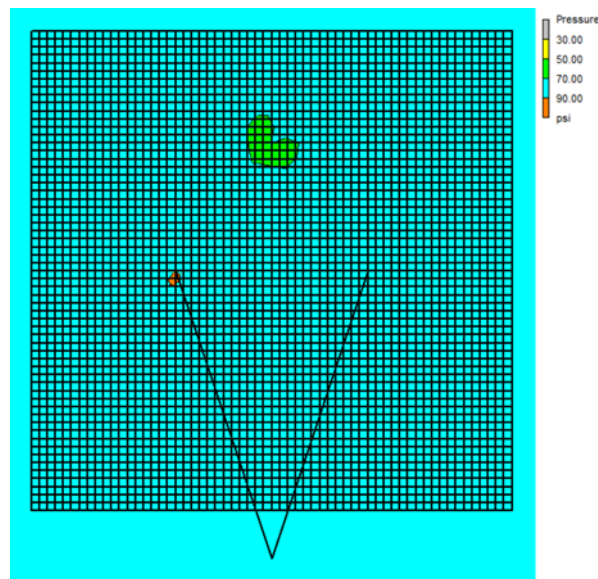

Note: 6-inch distribution pipe, 16-inch trunk lines every 6th distribution pipe; pressure distribution adequate everywhere. Total cost = \$1.95 billion.

Figure 6-33: Water network Case 4.

## NATURAL HAZARD MITIGATION SAVES:

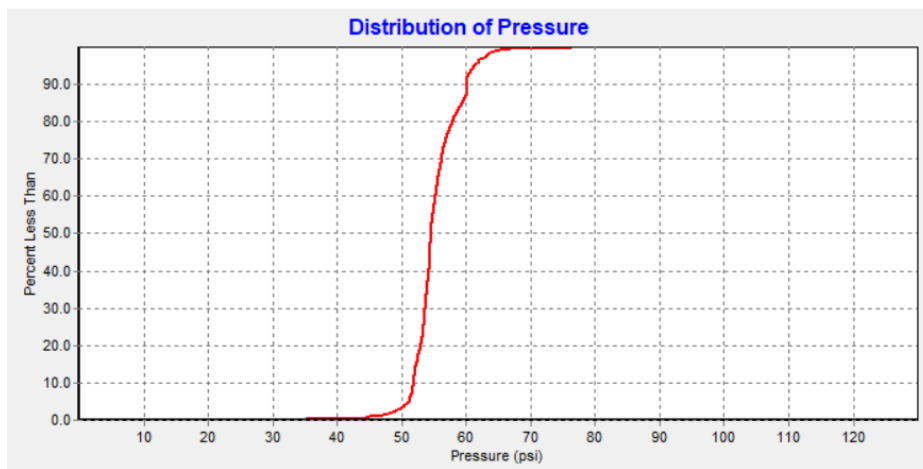
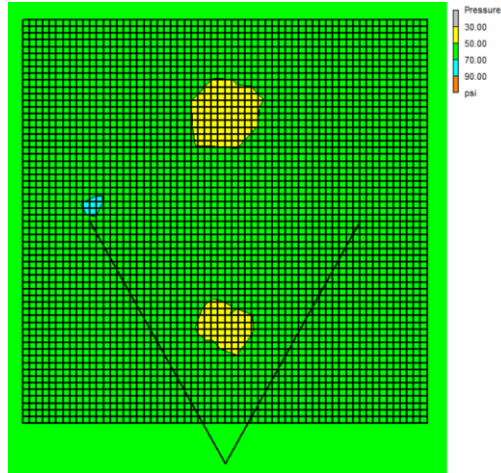

Note: 6-inch distribution pipe, 16-inch trunk lines every 10th distribution pipe; pressure distribution adequate everywhere. Total cost = \$1.72 billion, median nodal pressure 55 psi, acceptable.

Figure 6-34: Water network Case 5.



## NATURAL HAZARD MITIGATION SAVES:

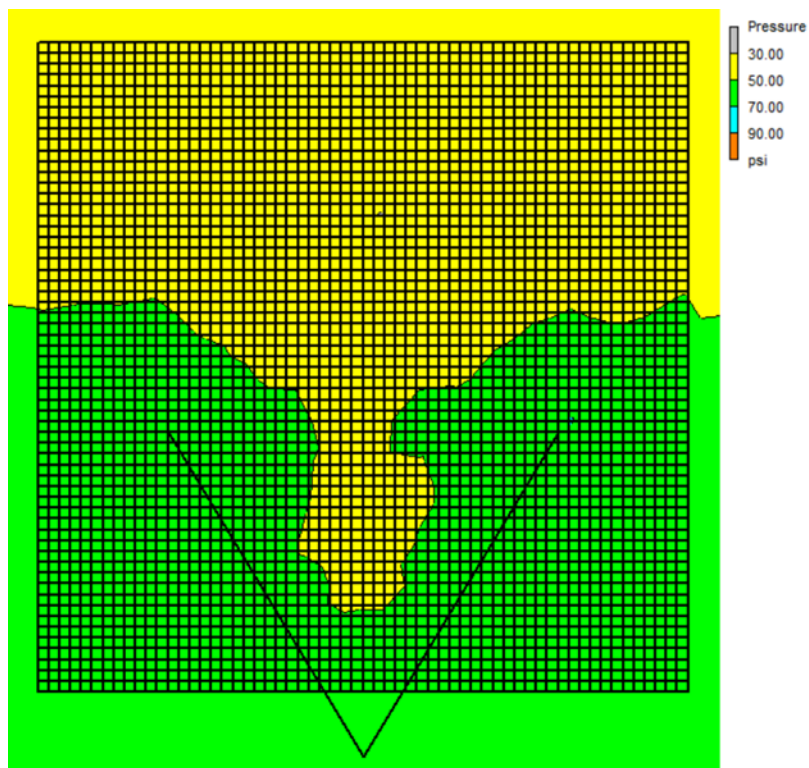

Note: 6-inch distribution pipe, 16-inch trunk lines every 12th distribution pipe; pressure distribution adequate everywhere. Total cost = \$1.66 billion.

Figure 6-35: Water network Case 6.

## NATURAL HAZARD MITIGATION SAVES:

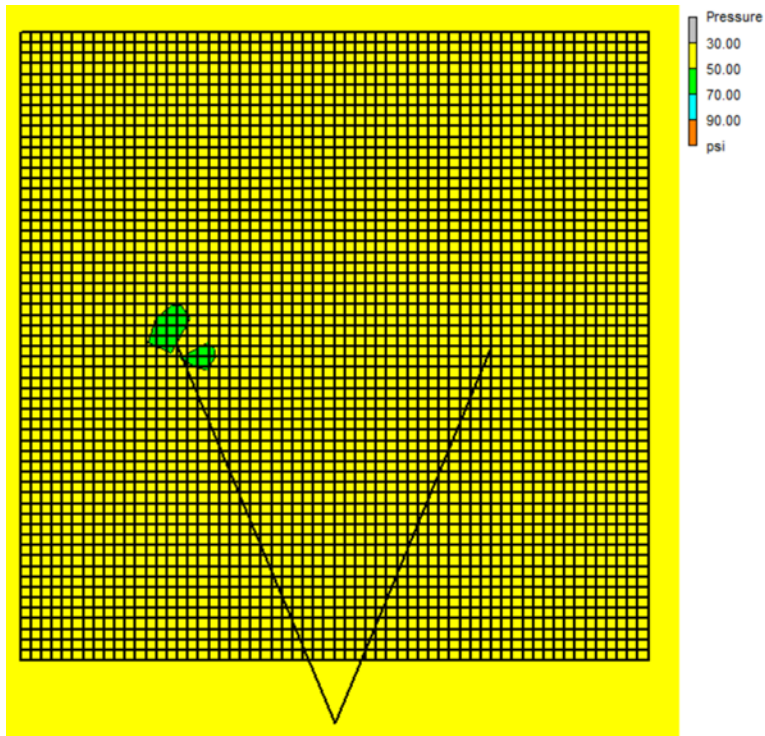

Note: 6-inch distribution pipe, 16-inch trunk lines every 15th distribution pipe; pressure distribution barely adequate everywhere. Total cost = \$1.61 billion.

Figure 6-36: Water network Case 7.

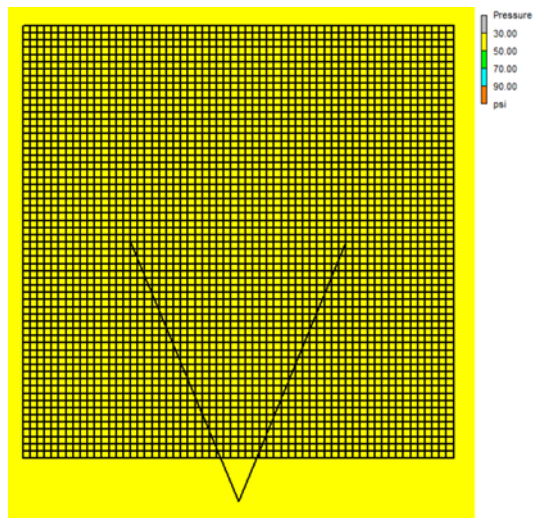

Note: 8-inch distribution pipe, 12-inch trunk lines every 15th distribution pipe; pressure distribution barely adequate everywhere. Total cost = \$1.76 billion.

Figure 6-37: Water network Case 8.

# NATURAL HAZARD MITIGATION SAVES:

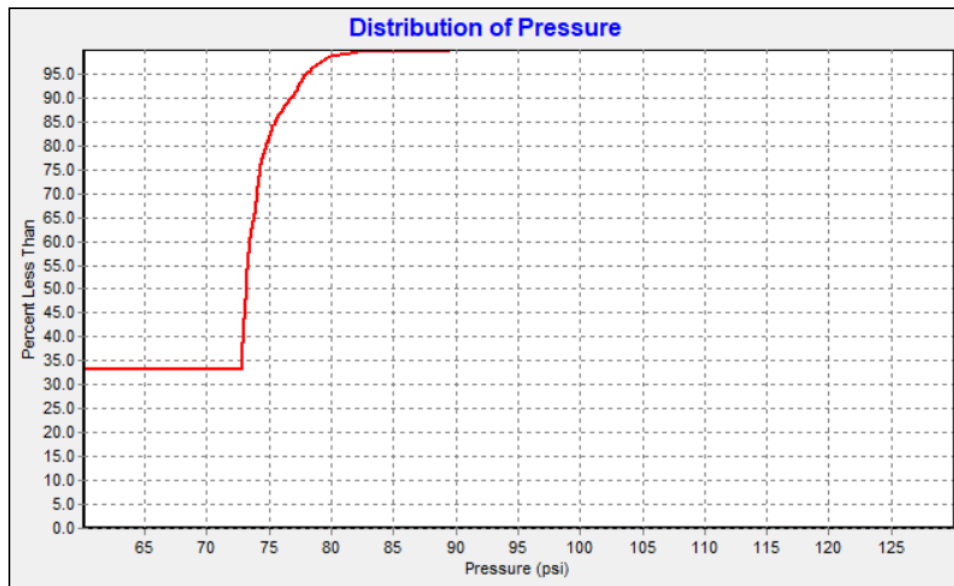
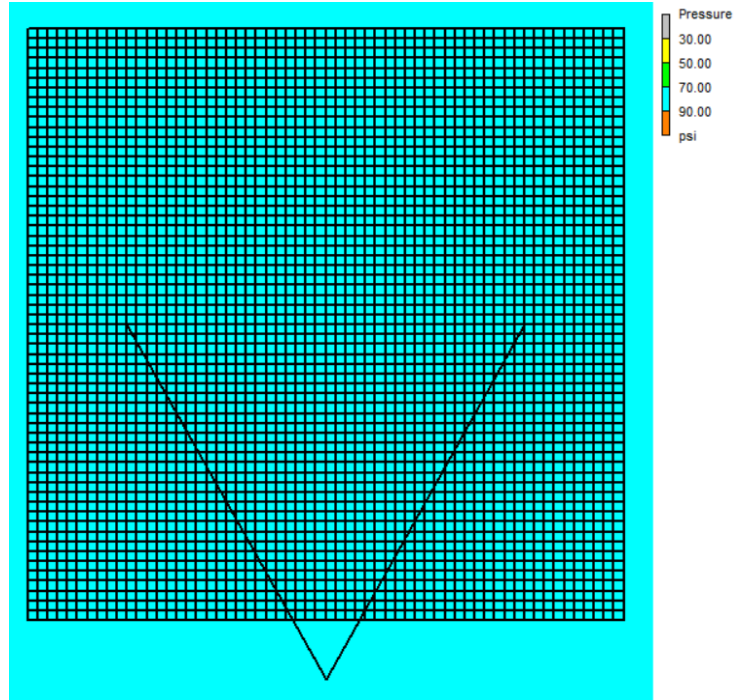

Note: 6-inch distribution pipe, 16-inch trunk lines every 10th distribution pipe; median nodal pressure 73 psi, Acceptable. Total cost = \$1.72 billion.

Figure 6-38: Water network Case 5A, no fire flow.

Table 6-19: Phase 1 as-is design results.

Case	Distrib. Diam.	Trunk lines		Cost (billions \$)	median nodal pressure ( $\bar{P}_n$ )	Acceptable?
		Diam.	Spacing			
1	6"	none	none	\$1.32	2	No
2	6"	16"	20th	\$1.55	6	No
3	6"	16"	5th	\$2.07	83	marginal
4	6"	16"	6 <sup>th</sup>	\$1.95	75	OK
5	6"	16"	10th	\$1.72	55	OK
5A	6"	16"	10th	\$1.72	73	OK (no fire flow)
6	6"	16"	12 <sup>th</sup>	\$1.66	50	OK
7	6"	16"	15th	\$1.61	42	marginal
8	8"	none	none	\$1.76	10	No
9	8"	12"	15th	\$1.98	35	marginal

As a form of validation, the project team compared the configuration of this initial design with the distribution system of the city of San Francisco, as shown in Table 6-20, demonstrating the as-is model is reasonably representative of a large U.S. city. Table 6-21 and Figure 6-39 show the comparison of the frequencies of distribution pipe diameters for several systems, and Table 6-22 and Figure 6-40 show the frequencies for pipe materials, showing, given the somewhat simplified nature of the model, reasonable agreement with real systems.

**Table 6-20:** Comparison of as-is design and city of San Francisco water distribution parameters.

Parameter		As-is design	San Francisco
2016 population (est.)		787,500	870,887
Area (sq. mi.)		47	47
Retail water use per capita (mgd, 2014-15)		70	77
total length pipe (millions ft)		4.9	6.5
length breakdown by size (%)	6"	90%	29%
	8"	-	37%
	10"	-	-
	12"	-	12%
	14"	-	-
	16"	10%	7%
	18"	-	0.2%
	20"	-	1.9%
	> 20"	-	7.9%

**Table 6-21:** Distribution of pipe diameters for as-is and selected water districts.

Diameter	As-is	San Francisco	EBMUD	LADWP
6	90%	29%	49%	50%
8	90%	66%	76%	75%
10	90%	66%	77%	76%
12	90%	78%	88%	87%
14	90%	78%	88%	87%
16	100%	85%	92%	90%
18	100%	85%	92%	90%
20	100%	87%	94%	91%
24	100%	95%	96%	93%

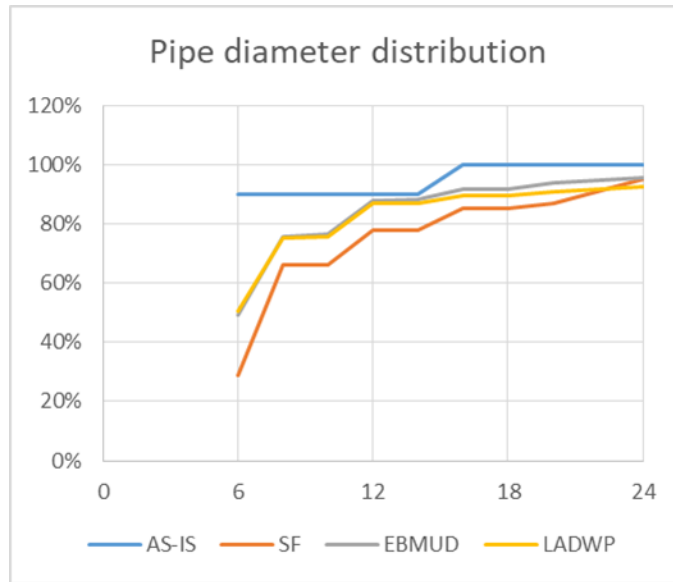

Figure 6-39: Distribution of pipe diameters for as-is and selected water districts.

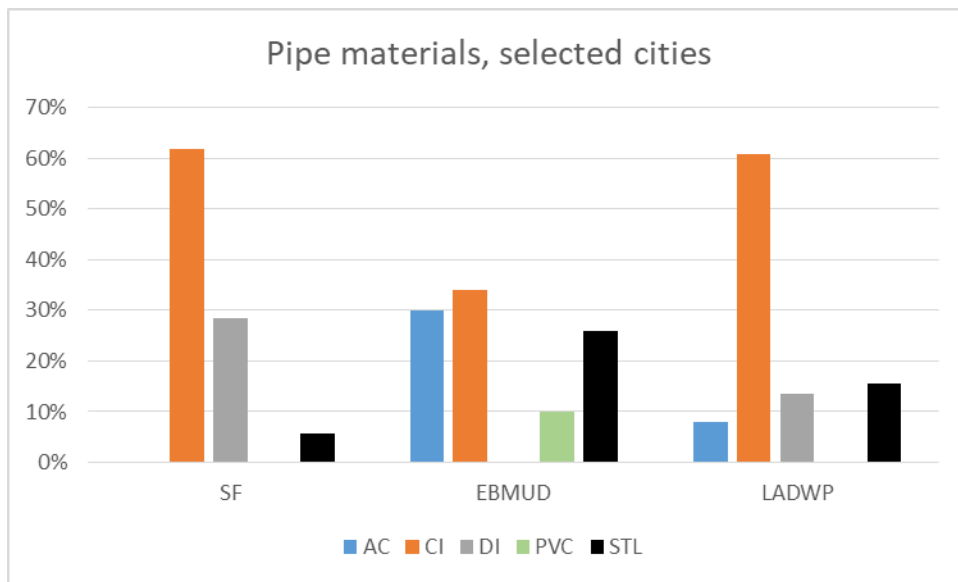

Figure 6-40: Distribution of pipe materials for selected water districts.

Table 6-22: Distribution of pipe materials for selected water districts.

Material	SF	EBMUD	LADWP
AC		30%	8%
CI	62%	34%	61%
DI	29%		14%
PVC		10%	0%
STY	6%	26%	15%

### 6.3.2.5. Rationale for Resilient Grid

In the previous section, a system representative of a medium-sized U.S. city has been sized to meet daily demands including fire flows, in a manner similar to how most water supply networks are sized. Designing in this manner however may fail to meet the demands of extraordinary events such as earthquakes. Such extraordinary demands can be met by several means. Designers can wholly increase the pipe diameter size of the distribution network, using new but ordinary pipe with its seismic vulnerabilities. However, this can be rather expensive. Alternatively, a designer can construct a wholly independent special system, such as San Francisco's Auxiliary Water Supply System or Vancouver, British Columbia's Dedicated Fire Protection System (Scawthorn et al. 2017; Scawthorn, Ballantyne and Blackburn 2000), although such systems also may be expensive.

Another option is to create a resilient grid that will survive the extraordinary event and facilitate temporary measures to meet the extraordinary demands. "A resilient network places seismically robust pipes at key locations and alignments to help increase the probability of continuous water delivery and reduce the time to restore areas suffering a loss of water services after an earthquake" (Davis 2017). This study examines the resilient grid concept. However, rather than piecemeal replacement of only selected pipes at key locations, the project team left the distribution grid untouched and replace the entire trunk line grid with ERDIP, which would be hydraulically isolated from the distribution line grid by seismically actuated valves following a major earthquake. In calculating benefit-cost, the project team included the cost of replacing the entire trunk line grid, even though portions of the trunk line grid in some cases might not require replacement (thus, the benefit-cost calculated in this study is probably an underestimate).

### 6.3.2.6. Pipeline Damage and Restoration

Earthquake damage to the pipe network is typically due to one of two mechanisms: "the *wave propagation* hazard and the *permanent ground deformation* (PGD) hazard. The wave propagation hazard is transient and corresponds to ground shaking. It results in transient strains in buried pipelines, strains that disappear when the shaking has stopped. The wave propagation hazard occurs in every event and generally leads to low to moderate damage rates for buried pipe (repairs per kilometer of pipe) over wide areas." (O'Rourke and Liu 2012).

The effect of PGD are much more damaging to pipes than wave-propagation effects, but PGD typically occurs only over a portion of a network, whereas wave-propagation effects typically affect the entire network. For example, in San Francisco in the 1989 Loma Prieta earthquake, there were 123 repairs concentrated in the relatively small Marina district (O'Rourke et al. 1990), all due to PGD effects, and only 35 repairs spread over the rest of the city (some of which were also due to PGD effects), so that the ratio of repair rates from permanent ground deformation to those of wave propagation was perhaps 135/23 or about 6 to 1.

To model leaks and breaks in pipe due to wave-propagation effects, the project team used the American Lifelines Alliance (ALA) repair rate estimate for buried pipe ALA(2001):

$$RR = K_1 0.00187 \times PGV$$

**Equation 6-1**

Where  $K_1$  is a factor to account for pipe material,  $RR$  = repairs per 1,000 ft. of main pipe and  $PGV$  is peak ground velocity in units of inches/second. The project team used  $K_1 = 0.75$  to account for the as-is model being a mix of CI, DI and other pipe types. The 0.75 factor was arrived at after a review of such factors in (ALA 2001). Thus, the total number of repairs to distribution pipe, denoted here by  $N_{dr}$ , and the total number of repairs to trunk lines, denoted by  $N_{tr}$ , can be estimated given the total length of distribution and trunk lines affected by various levels of  $PGV$ , respectively.

Following commonly accepted assumptions, (Cornell University 2008; DHS 2003) 80% of repairs are due to wave passage ( $PGV$  effects) repair leaks and the remaining 20% repair breaks. Leaks come in four possible types: annular, round, longitudinal, and local loss of wall (also called windowpane). Using relations and frequencies (Cornell University 2008) for equivalent orifice area (EOA) for each leak type, the project team developed an overall average EOA, which it employed for random repairs. The specific equivalent orifice diameter (EOD) is well approximated by  $EOD = d \times (0.5d^{0.155})$ . Thus, if the pipe diameter  $d$  is 6 inches, then the average EOD is 2.29 inches, including a 20% weighting of a full pipe break.

Modeling leaks and breaks in pipe due to  $PGD$  effects is more problematic for this study in that the location(s) of  $PGD$  needs to be specified.  $PGD$  effects (mostly liquefaction, lateral spreading, landslide, and fault slip) typically only affect a portion of a network. For example, Figure 6-41 to Figure 6-45 show potential liquefaction zones for several major West Coast cities. Moreover, the location of the  $PGD$ -impacted area, whether it is central to the system, or near the major supply nodes, or on the far margins of the network, will greatly affect the impact on the network. Rather than specify a location, or take a probabilistic approach, the project team considered ground-failure effects by averaging  $PGD$  repair rates over the entire region, and combining them with wave-propagation repair rates. That is, the project team assumed about one sixth (16.7%) of the study region is subject to  $PGD$  effects, with a 6 to 1 ratio of repair rates from  $PGD$  to those of wave propagation, resulting in the overall number of repairs due to  $PGD$  effects being equal in number to those due to wave-propagation effects, so that by simply doubling Equation 6-1,  $PGD$  effects are reasonably accounted for. It should be noted that repairs associated with  $PGD$  are more likely to be breaks than leaks, perhaps by as much as a factor of four (ALA 2001). So, this study may underestimate breaks resulting from permanent ground deformation, their hydraulic consequences, and, ultimately, benefits of the resilient grid.

A fully probabilistic Monte Carlo analysis would be of interest, but the additional effort does not seem necessary to achieve the objectives of this project.



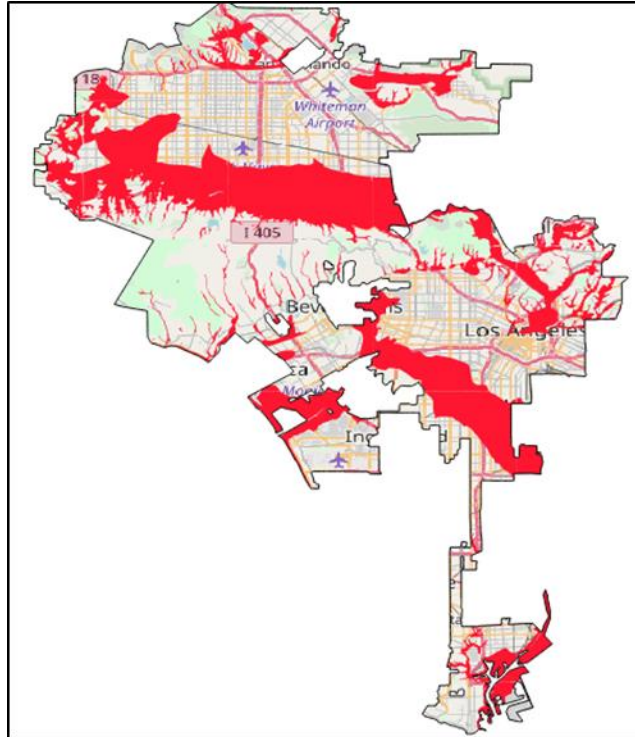

Source: [http://geohub.lacity.org/datasets/4842ad85584c430481246852280257c2\\_9](http://geohub.lacity.org/datasets/4842ad85584c430481246852280257c2_9)

Figure 6-41: City of Los Angeles, with potential liquefaction zones shown in red.

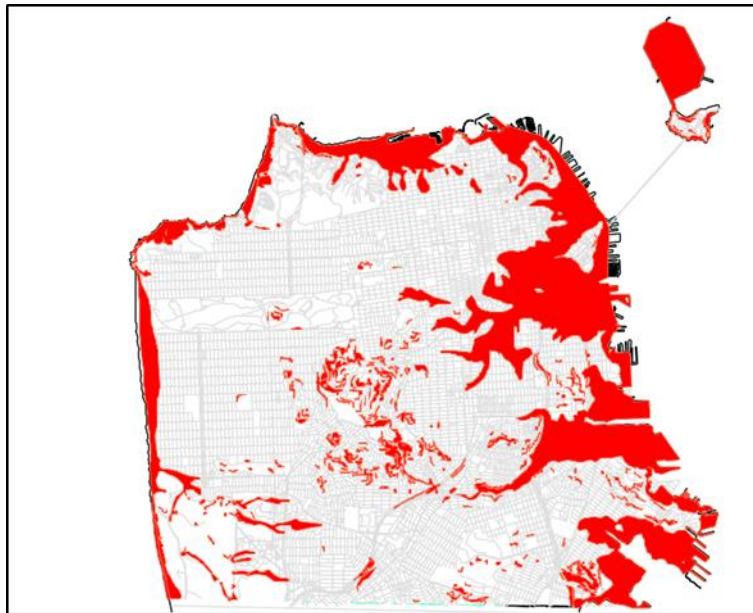

Source: <https://data.sfgov.org/City-Infrastructure/San-Francisco-Seismic-Hazard-Zones/7ahv-68ap/data>

Figure 6-42: City of San Francisco, with hazard zones (almost entirely liquefaction, some landslide in the middle of the city) shown in red.

NATURAL HAZARD MITIGATION SAVES:

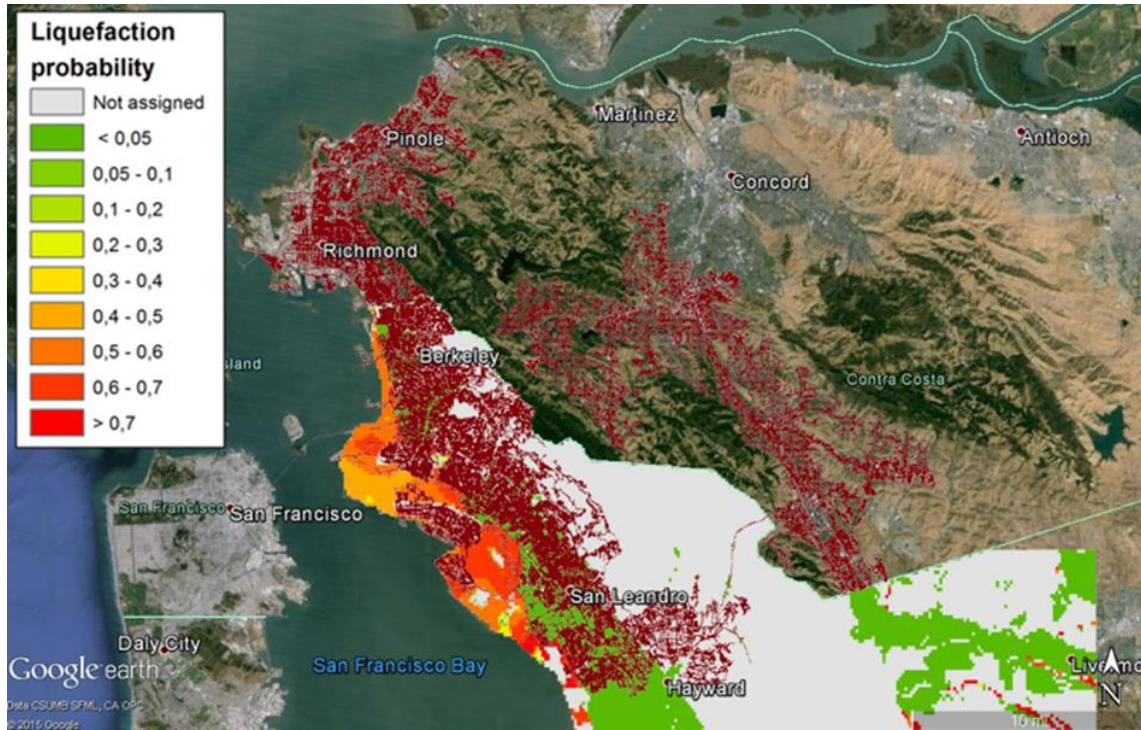

Figure 6-43: EBMUD liquefaction zones (Porter 2018).

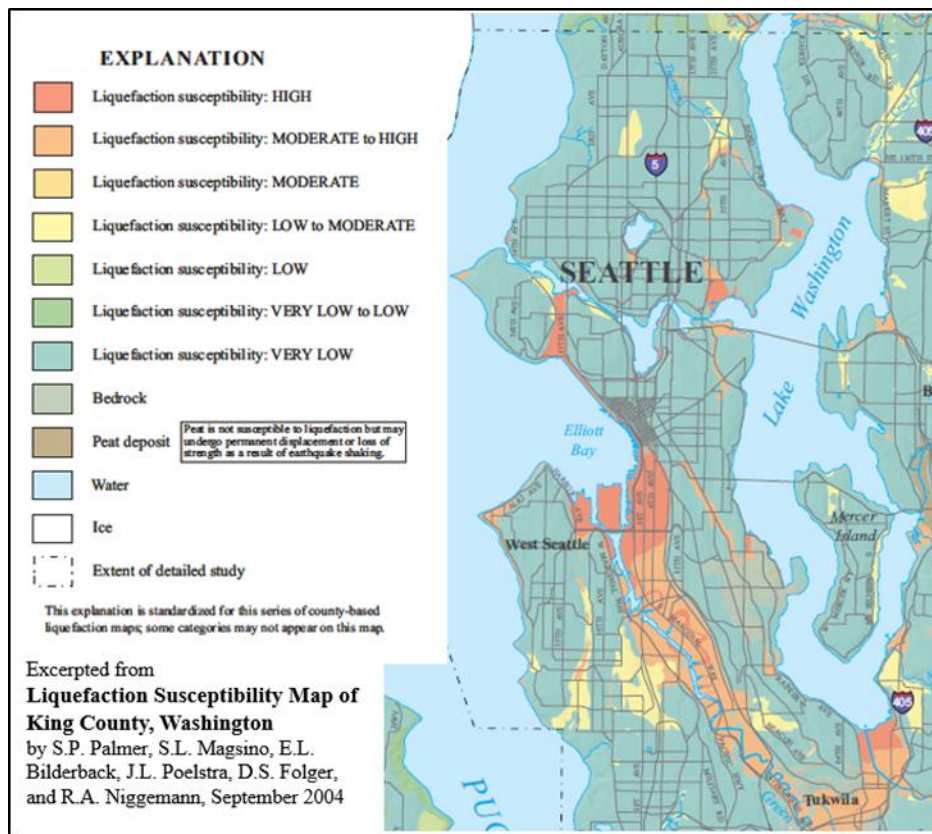
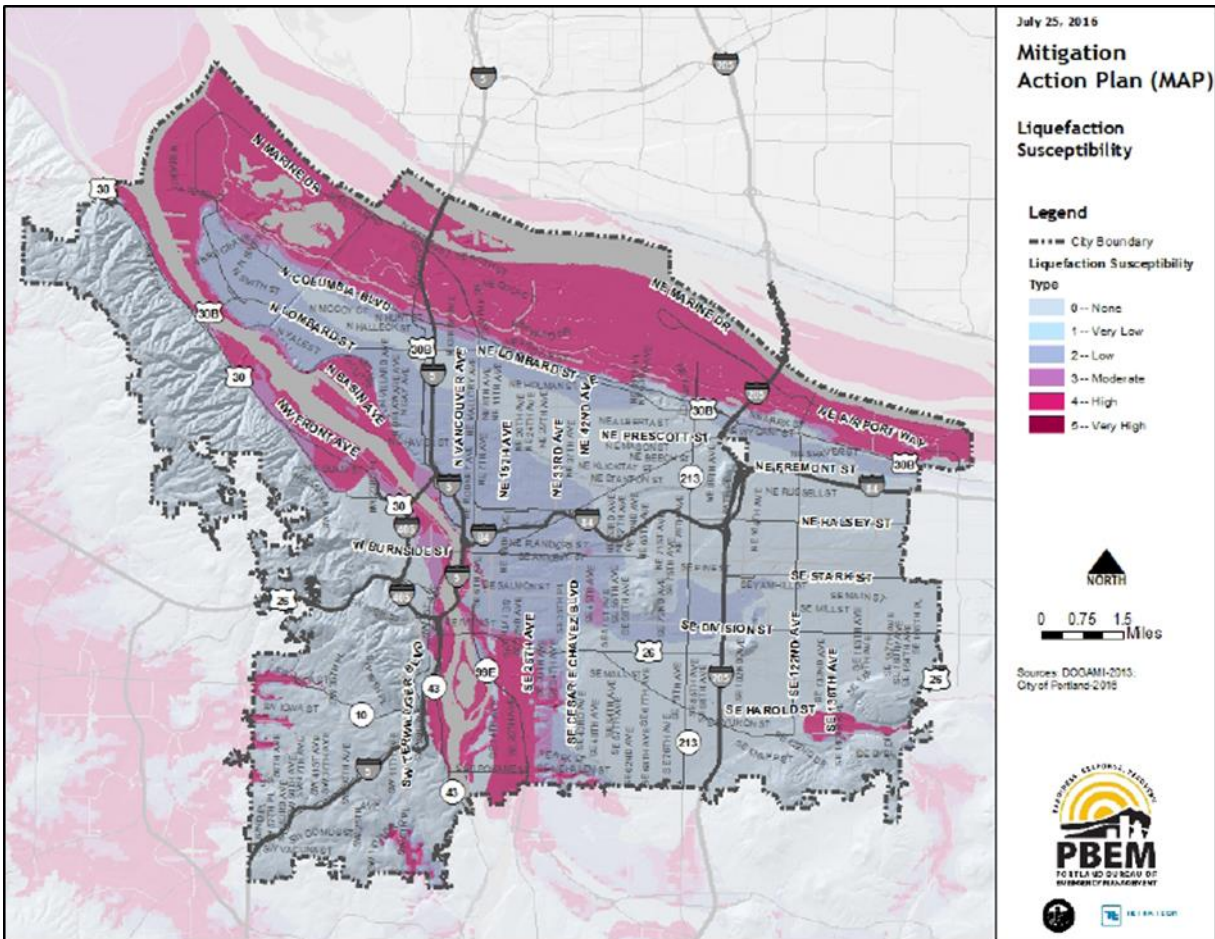

Figure 6-44: City of Seattle liquefaction zones.



Source: <https://www.portlandoregon.gov/pbem/>

Figure 6-45: City of Portland liquefaction zones.

Regarding recovery, the method of Porter (2018) is followed in a somewhat simplified manner. Repairs to distribution pipe require  $R_d = 7.6$  crew-hours to accomplish, while repairs to trunk lines require  $R_t = 16.1$  crew-hours. Crews work  $H_{day}$  hours per day, assumed to be 12 hours per day, until all repairs are completed, and several crews can work on one repair to shorten the time required for completing the repair. Repairs are assumed to be initiated immediately following the earthquake, and to progress at the above rates until completed. The duration of repairs depends on the number of repair crews available. The total number of repair crews, denoted by  $T_{crew}$  is estimated as the total number of service connections normally in service, divided by 10,000 (Porter 2018):

$$T_{crew} = (\text{total number of service connections})/10,000$$

Equation 6-2

That is, if a water agency has 225,000 service connections (e.g., the project study area), it has 23 crews. These are in-house crews. For extraordinary events, crews are added by mutual aid. They are assumed to arrive gradually, with an additional  $T_{ma} = 20\%$  of the number of crews already on site arriving each day

## NATURAL HAZARD MITIGATION SAVES:

after the first day. Mutual-aid crews arrive until the number of mutual-aid crews equals the number of in-house crews, which happens on the Day 6 after the earthquake. Mutual-aid crews are assumed to stay until the repairs from the mainshock are completed. (This analysis excludes repairs associated with aftershocks.) For the above example, on Day 1, the agency can draw on 23 crews, on Day 2 there are 28 crews, and so on, as shown in Table 6-23 with corresponding number of repairs.

**Table 6-23:** Maximum possible repairs per day.

Day	1	2	3	4	5	6	7	8	9	10
Number of crews	23	28	34	41	46	46	46	46	46	46
Distrib. repairs per day	36	44	53	64	72	72	72	72	72	72
Cum. distrib. repairs	36	80	133	197	269	341	413	485	557	629
Trunk repairs per day	17	21	25	31	34	34	34	34	34	34
Cumulative trunk repairs	17	38	63	94	128	162	196	230	264	298

Given the above, solve for  $D_c$ , the total number of days required to complete all repairs, using Equation 6-3:

$$2(R_d N_{dr} + R_t N_{tr}) = \sum_{D=0}^{D_c} \{T_{crew} [(1 + T_{ma})^D \leq T_{max}] H_{day}\}$$

**Equation 6-3**

The left-hand side of the equation gives crew-hours required to perform  $2 \times (R_d + R_t)$  repairs, the factor of 2 accounting for pipe repairs associated with ground-failure, not included in Equation 6-1. The right-hand side of the equation gives the number of crew-hours expended by Day  $D_c$ . The inequality in the right-hand side of Equation 6-3 is shorthand notation to cap at  $T_{max}$  the number of crews on Day  $D$  as a multiple of  $T_{crew}$ . The multiple is taken here as  $T_{max} = 2$ .

### 6.3.2.7. Modeling Fire Ignition, Growth, and Firefighting Response

For fires following earthquake, the project team assumed an average total floor area per capita, for all types of building occupancies of  $TFA_{pc} = 640$  sq. feet, taken from ATC-52-1 (Applied Technology Council 2010) for a total floor area ( $TFA$ ) of 504 million square feet for the entire as-is model. The project team estimated the number of ignitions using Equation 6-4, in which shaking is measured using peak ground acceleration,  $PGA$ , measured in units of gravity,  $g$ . See SPA Risk (2009).

$$I_{gns} = (0.5819 \times PGA^2 - 0.0294 \times PGA) \times TFA$$

**Equation 6-4**

In the equation,  $I_{gns}$  refers to the number of ignitions and is rounded to the nearest whole number, and  $TFA$  is measured in units of millions of square feet. For example,  $PGA = 0.3g$  produces a mean of 22

ignitions for the study area. In the present calculations, ignitions are random and may vary around this mean.

Estimating the water needed for fire suppression is a complex matter (Technical Council for Lifeline Earthquake Engineering 2005). This study assumes a modest delay in reporting and response such that the equivalent of three structures are involved when firefighters arrive at the fire. Using guidelines in DHS (2003), to fight a fire involving three structures requires a fire flow (a flow of firefighting water) of 3,000 gpm. Large fires require significantly larger fire flows. For 10 ignitions, the total required fire flow equates to 30,000 gpm. For reference, a normal fire engine's maximum capacity is 1,500 to 2,000 gpm.

Thus, if the system were subjected uniformly to shaking of  $MMI = 7$ , the total demands on the system includes the ordinary service connection demands of 49,212 gpm; no ordinary fire demands; break and leak demands (assuming full pressure for the full 4.9 million ft. of pipe) of about  $4.9 \times 17,700 = 86,765$  gpm; and extraordinary fire demands of 39,000 gpm, for a total of 174,977 gpm. This is the desired total flow. The question is whether the damaged system can furnish it.

The number of fire engines is assumed to total only those belonging to the jurisdiction, on the assumption that (at least initially) nearby jurisdictions are all affected by the earthquake and cannot assist for the first 12 hours. (This assumption is dependent on mutual aid and other factors, and should probably be examined further.) The number of engines for a jurisdiction is estimated as:

$$NFE = 3.82 + 0.052 \times P \quad n = 202, \quad r^2 = 0.45$$

Equation 6-5

The equation is based on unpublished work by Scawthorn. In the equation,  $NFE$  = number of fire engines (rounded to nearest whole number) and  $P$  is residential population in thousands. The value  $n = 202$  in the equation refers to the number of jurisdictions examined, and  $r^2$  refers to the coefficient of determination from the regression analysis that produced the equation. For the study area, with a population of 787,500, Equation 6-5 rounds to 45 engines. By comparison, the city of San Francisco with a 2016 population of 871,000 has 44 engines. Using Equation 6-5 would produce an estimate of 49 fire engines for San Francisco, suggesting reasonable agreement. (San Francisco has experienced very rapid population growth recently. Its 2010 population was 805,000, which would equate to 46 engines, and its 2000 population was 777,000, which would imply 44 engines).

Firefighting is a complex matter (Technical Council for Lifeline Earthquake Engineering 2005). The project team used simplified but reasonable assumptions typical of West Coast cities (e.g., wood bared residential construction), as follows:

- a. Ignitions initially require two engines to respond. Thus, for the study area if there are more than 22 ignitions, the number of ignitions exceeding 22 are initially unfought because of insufficient engines. Those fires grow. They are referred to here as large fires because they will rapidly grow to involve a large number of buildings.

- b. Ignitions that are within 1,000 feet of a node with at least 20 psi pressure are responded to first, by two engines, and are confined to three buildings (or a very few neighboring buildings) such that the property loss is small relative to conflagrations that develop from large fires. These smaller fires are neglected for present purposes.
- c. Ignitions that are farther than 1,000 feet from a node with pressure of at least 20 psi require an additional engine for each increment of 1,000 ft. for hose-relay purposes. If there are insufficient engines to relay water, the ignition grows to become a large fire, because responding fire engines will not have water to suppress the fire.
- d. Large fires within a few tens of minutes grow to involve several buildings that under ordinary circumstances would require second or greater alarm<sup>32</sup> (i.e., at least two engines). If the number of fire engines available for a large fire is five or more, the property loss is still relatively small, and is neglected for present purposes. If fewer than five engines are available, then a large fire grows to a size that cannot be contained, and will cross several firebreaks (e.g., streets). The actual extent is highly dependent on wind speed, street width, building setback, building cladding, roofing, and other factors. Based on a review of typical conditions in the San Francisco Bay and Los Angeles regions (Scawthorn 2018; Scawthorn 2011), it is assumed here that the average large fire burns five city blocks. This may seem an extraordinarily large area, but it must be kept in mind that by definition large fires are unfought, either because of insufficient engines or insufficient water. As such, there is nothing to stop their spread, save the cumulative probability of not crossing a firebreak. Given reasonable ranges of this probability, it can be shown that five city blocks is an average total burned area. For the study area, this equates on average to buildings per large fire  $B_{LF} = 5 \times 62.5 = 312.5$ , which have a total population per large fire,  $P_{LF}$  of  $3.5 \times 312.5 = 1,094$  occupants. Given there are 640 sq. feet of floor area per occupant, equivalent to 2,240 square feet per building,  $TFA_{LF}$  or total floor area per large fire is 700,000 square feet.

### 6.3.2.8. Estimating Water and Fire Losses

Losses associated with damage to water supply include:

- Pipeline repair cost, denoted here by  $C_{utility}$
- Direct BI loss to water customers who lose service, denoted by  $C_{DBI,w}$
- Buildings that burn in fires that grow only because of lack of adequate firefighting water supply, resulting in:
  - Cost of property damage, denoted by  $C_{PL}$
  - Deaths, financially quantified here in terms of DOT's acceptable cost to avoid statistical deaths and denoted by  $C_{mort}$

---

<sup>32</sup> The meaning of and number of fire engines responding to a "greater alarm" varies by department due to such factors of department size, building density and construction. In general, a first alarm has a response of two or three engines (as well as other apparatus, not relevant here) with another two or three engines for each additional alarm.

## NATURAL HAZARD MITIGATION SAVES:

- Nonfatal injuries financially quantified here in terms of the DOT's acceptable cost to avoid a statistical serious injury (AIS level 3) and denoted by  $C_{morb}$
- Cost of PTSD among occupants, denoted here by  $C_{PTSD}$
- Direct BI loss to customers, denoted by  $C_{DBI,f}$
- Indirect BI to the rest of the economy that does business with the customers whose homes or buildings burn down because of fires that grow only because of inadequate firefighting water, denoted by  $C_{IBI,f}$

The total property loss associated with repairs (denoted here by  $C_{rep}$ ) includes the actual cost to the water utility of the repair (i.e., labor and materials), plus  $C_{cust}$  the cost to customers of the loss of service:

$$C_{rep} = C_{utility} + C_{cust}$$

Equation 6-6

Cost to the water utility for all repairs is:

$$C_{utility} = \sum_{D=0}^{D_c} (C_{rep/hr} T_{crew} H_{day} D)$$

Equation 6-7

where  $C_{rep/hr}$  is cost of repairs per hour equal to  $C_{repLabor}$  dollars per hour per worker, assumed here to be \$100 per hour per worker and a four-person crew times a factor  $F_{repMats}$  to account for cost of materials and equipment, assumed here to be 30% so that the hourly cost of repairs is:

$$C_{rep/hr} = F_{repMats} \times C_{repLabor}$$

Equation 6-8

while  $D_c$ ,  $H_{day}$ , and  $T_{crew}$  are defined in the section on repairs, above.

Cost to customers  $C_{cust}$  is assumed solely to be due to the cost of loss of service  $C_{los}$ , which is estimated at \$720 per day per service connection, based on the total regional economic loss attributed to loss of water in the 2008 Shakeout study (Jones et al. 2008), divided by the number of customers affected. Thus for example, if one incident of pipe damage removes 100 service lines from service, and the repair cannot be made until three days following the incident, the cost of loss of service to customers is  $3 \times 100 \times \$720 = \$216,000$ .

The total cost due to fires,  $C_F$ , is the sum of financial cost due to human casualties, property losses and direct BI:

$$C_F = C_{PL} + C_{HI} + C_{BI}$$

Equation 6-9

## NATURAL HAZARD MITIGATION SAVES:

where  $C_{PL}$  is the cost of property losses,  $C_{HI}$  is the value lost or cost of human injury, and  $C_{BI}$  is the cost of direct BI, in millions of dollars.

Regarding property losses, a replacement value Cbldg for buildings typical of West Coast cities of \$200 per square foot (RSMMeans 2016) is employed with an addition for contents of  $A_{cont}$  of 50%, for a total  $C_{prop}$  of \$300 per square foot. Given that the total floor area destroyed per large fire,  $TFA_{LF}$  is 700,000 square feet, the property loss per large fire is a  $C_{PL}$  of \$210 million per Equation 6-10.

$$C_{PL} = TFA_{LF} \times C_{prop}$$

Equation 6-10

Estimation of value lost due to human injury  $C_{HI}$  follows the methods in Multihazard Mitigation Council (2018) and is the sum of values lost, or costs, due to mortality and morbidity  $C_{MM}$  and PTSD  $C_{PTSD}$ :

$$C_{HI} = C_{MM} + C_{PTSD}$$

Equation 6-11

Estimating the frequencies of mortality and morbidity due to post-earthquake fires is difficult. Many earthquakes have very few deaths due to fires, but a few earthquakes are dominated by fire (Spence, So and Scawthorn 2011; Technical Council for Lifeline Earthquake Engineering 2005). On the one hand, earthquakes can be regarded as an alarm that will alert the population so that they will not be trapped by fire, while on the other hand collapsed buildings may trap people who cannot extricate themselves from the path of fires.

The project team employed a simple approach here, consisting of a review of U.S. fire statistics for the period 2003-2015 (USFA 2018). In that period, on average, there were 0.27 fatalities and 1.39 injuries per million dollars of property loss, which are the ratios used here for  $f_{mort}$  and  $f_{morb}$  per million dollars of property loss. See Table 6-24. The value of a statistical life, or cost  $C_{mort}$  due to a fatality is \$9.4 million, and value of a statistical injury, or cost  $C_{morb}$ , due to an injury is \$0.55 million.

$$C_{MM} = C_{PL}(C_{mort}f_{mort} + C_{morb}f_{morb})$$

Equation 6-12

which equates to  $(0.27 \times \$9.4 + 1.39 \times 0.55) = \$3.3$  million per million dollars of property loss – that is, the cost of mortality and morbidity is 3.3 times larger than the property loss.

Regarding PTSD, the project team assumed all customers in buildings destroyed by large fires suffer PTSD, due to which there is a value lost or cost  $C_{PTSDpc}$  of \$33,750 per person (Multihazard Mitigation Council 2018).



Table 6-24: U.S. fire statistics 2003-2015 (USFA 2018).

Year	All building fires	Deaths	Injuries	Loss (\$ million)	Deaths per \$ million loss	Injuries per \$ million loss
2003	484400	3185	14825	10259	0.31	1.45
2004	491700	3120	14850	9759	0.32	1.52
2005	477900	2935	14775	10478	0.28	1.41
2006	491600	2565	13900	10570	0.24	1.32
2007	493300	2855	14800	11460	0.25	1.29
2008	475300	2750	14350	12631	0.22	1.14
2009	445400	2570	14100	11069	0.23	1.27
2010	447000	2635	14650	9834	0.27	1.49
2011	449900	2530	15000	9575	0.26	1.57
2012	466800	2450	14500	9884	0.25	1.47
2013	474000	2820	13875	9500	0.30	1.46
2014	479000	2825	13275	9488	0.30	1.40
2015	485500	2635	12800	9790	0.27	1.31
mean	473,985	2,760	14,285	10330	0.27	1.39
Standard deviation	16,308	217	644	887	0.03	0.12

Given that the affected population per large fire,  $P_{LF}$ , is 1,094 persons, the cost of PTSD per large fire is:

$$C_{PTSDpLF} = C_{PTSDpc} \times P_{LF}$$

Equation 6-13

or \$36.9 million per large fire. Given  $C_{PL}$  the property loss per large fire is \$210 million, the total cost of human injury per large fire is then  $3.3 \times \$210 \text{ million} + \$36.9$ ; that is,  $C_{HI} = \$667 \text{ million}$ .

Regarding BI, the project team used the approach of \$69 per day per household for additional living expenses, for a period of 720 days. For a large fire, then 5 blocks  $\times$  62.5 HH/blk  $\times$  \$69/day  $\times$  720 days =  $C_{BI} = \$15.5 \text{ million BI costs per large fire}$ .

In summary then, the cost of a large fire, which on average destroys five city blocks, is  $C_F = (C_{PL} = \$210 \text{ million}) + (C_{HI} = \$667) + (C_{BI} = \$15 \text{ million}) = \$892 \text{ million}$ .

The project team applied these values and methodology to the study area for increasing earthquake shaking intensities, using hydraulic analysis to determine how the water supply network will cope with

these demands. Based on the response of the network, the project team determined the number of large fires, and final burnt area, as well as the number and duration of households without water service.

### 6.3.2.9. Benefit-Cost Analysis

The project team calculated the benefit of a resilient grid is calculated as the present value of the reduction in losses, accounting for the frequency of shaking that causes those losses. The mathematics are calculated in a later section of this report.

### 6.3.3. Vulnerability Under As-is Conditions

As used here, vulnerability means loss conditioned on a level of environmental excitation. This section estimates losses and then applies the extraordinary demands on the as-is system resulting from increasingly strong shaking, quantified in terms of a uniform level of seismic intensity applied across the entire region. The project team used *PGV* for estimation of pipe damage, and *PGA* for estimation of ignitions, as discussed above. Calculations are performed using these two measures of ground motion, but for presentation purposes only, results are presented in terms of MMI 6,7,8, 9 and 10<sup>33</sup>, converted to MMI using Wald et al. (1999). Given a level of ground shaking, the demands on the system are the ordinary demands excluding ordinary fire flows, plus leaking and broken pipes, plus fire flows from fires arising from the extraordinary event.

For MMI 6, using the above methodology, stochastic analysis finds 29 distribution pipe and no trunk line repairs are required, with 4 ignitions. See Figure 6-46. Total flow increases to 69,220 gpm (versus normal flow of 59,212 gpm including normal fire flows), virtually all nodal pressures exceed 10 psi pressure, so no services lose water, about 70% of nodes have pressures exceeding 20 psi (minimum for fire flow) so that the initial fire flow demands of 3,000 gpm for the 4 extraordinary fires are largely (not fully) met, averaging about 1600 gpm.

---

<sup>33</sup> MMI are denoted in Arabic (rather than Roman) numerals.

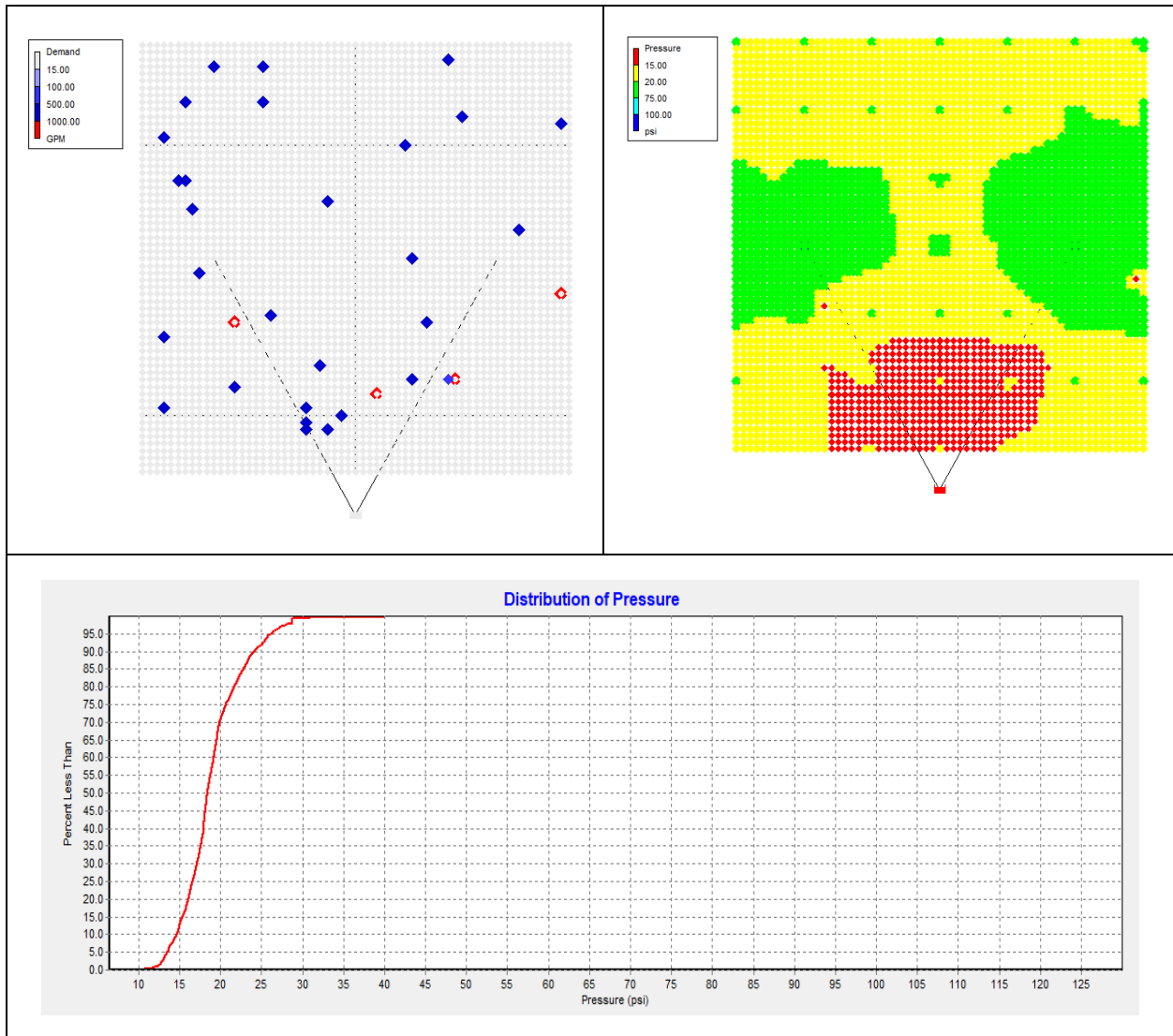

Note: Top left: 6-inch distribution lines every block and 16-inch trunk lines every 10th distribution line. Demand: normal demand (13.67 gpm) is light gray. The 29 leaks and breaks, and fires, are shown as blue or red diamonds; (top right) nodal pressure – virtually all nodes have pressures > 10 psi but 70% are less than 20 psi; (bottom) frequency distribution of pressure. Total system demand = 69,220 gpm.

Figure 6-46: MMI 6 with as-is design.

The project team calculated that 29 repairs would all be completed within one day, for a cost to the utility of about \$110,000. Financial loss due to the loss of service is negligible.

Regarding fires, while fire demands are not fully met initially, the small number of fires compared to the resources (45 engines) would suggest a low likelihood fires develop into large fires, so fire losses are negligible.

## NATURAL HAZARD MITIGATION SAVES:

For MMI 7, stochastic analysis finds 63 distribution pipe and 7 trunk line repairs are required, and 6 ignitions occur, with total flow 73,386 gpm. See Figure 6-47. Immediate impacts are:

- Nodal pressures are less than 10 psi for 85% of the population, so that Day 1 economic loss due to loss of water service is  $85\% \times 225,000 \text{ services} \times \$720 \text{ loss/service/day}$ , or \$138 million.
- All nodal pressures are less than 20 psi. However, there are more than five engines per fire so no fires grow to be large fires.

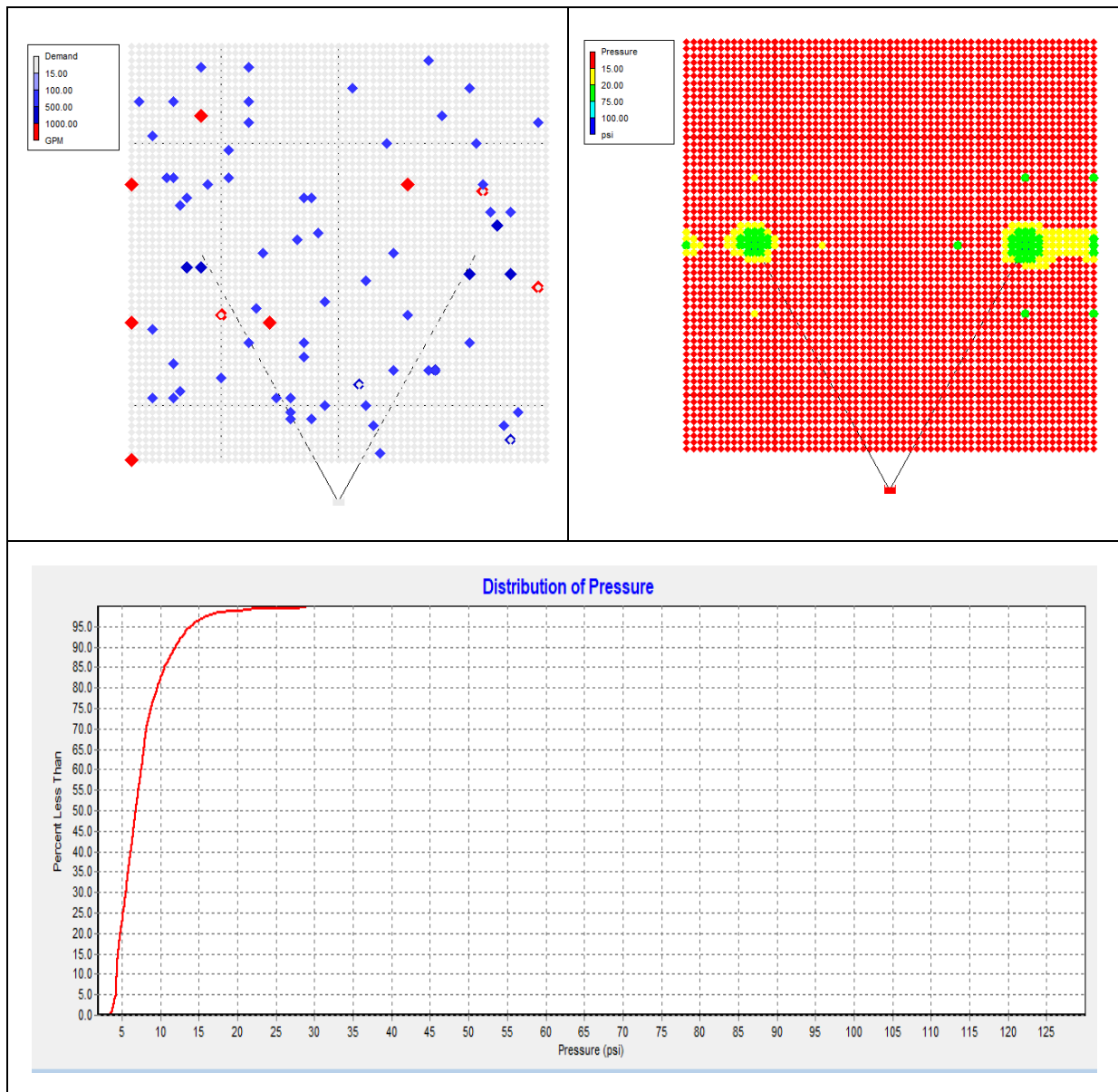

Note: Demand: normal demand (13.67 gpm) is light gray, 70 total leaks and breaks and the 6 fires shown as diamonds; (upper right and bottom) about 85% nodes have pressures > 10 psi but all are less than 20 psi. Total system flow = 73,386 gpm.

Figure 6-47: MMI 7, as-is design.

## NATURAL HAZARD MITIGATION SAVES:

At 24 hours after the event (i.e., end of Day one), all fires are extinguished or burnt out, all trunk line repairs and all distribution line have been completed and all services have been restored. Total losses then are \$138 million for loss of service and \$0.32 million for utility cost of repairs.

For MMI 8, stochastic analysis finds 111 distribution pipe and 9 trunk line repairs are required, with 21 ignitions, see Figure 6-48. Total flow increases to 74,817 gpm. Immediate impacts are:

- All nodal pressures are less than 10 psi so that Day one economic loss due to loss of water service \$162 million.
- All 21 fires have insufficient water and grow to be large fires, so that total fire loss is \$18.7 billion. It should be noted that even with perfect water supply, a maximum of 22 fires could be responded to, so that this loss is can be attributed entirely to loss of water.

At 24 hours after the event (i.e., end of Day 1) all fires are extinguished or burnt out, all 9 trunk line repairs and 17 distribution line have been completed. See Figure 6-49. These repairs reduce flow to 72,164 so that 70% of service pressures are less than 10 psi, resulting in \$113 million in economic loss.

At the end of Day 2, all trunk line and 61 distribution repairs are completed, which reduces flow to 69,851 gpm and 100% of services with pressure greater than 10 psi. Total utility cost of repairs is \$0.53 million.

# NATURAL HAZARD MITIGATION SAVES:

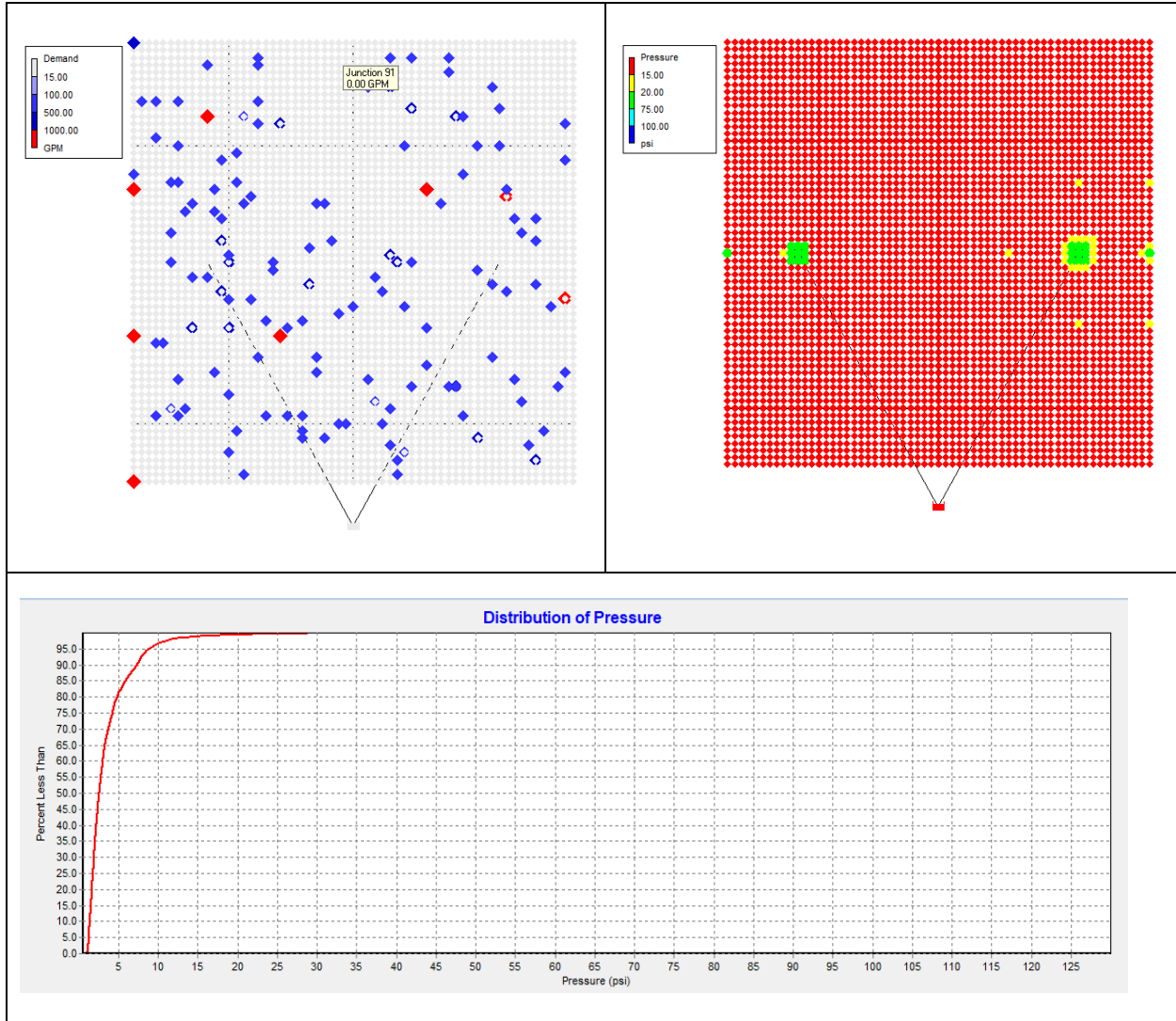

Note: Virtually all nodal pressures are below 10 psi. Total system flow is 74,817 gpm.

Figure 6-48: MMI 8 as-is design. sustains 111 distribution and 9 trunk line repairs, and 21 ignitions occur.

## NATURAL HAZARD MITIGATION SAVES:

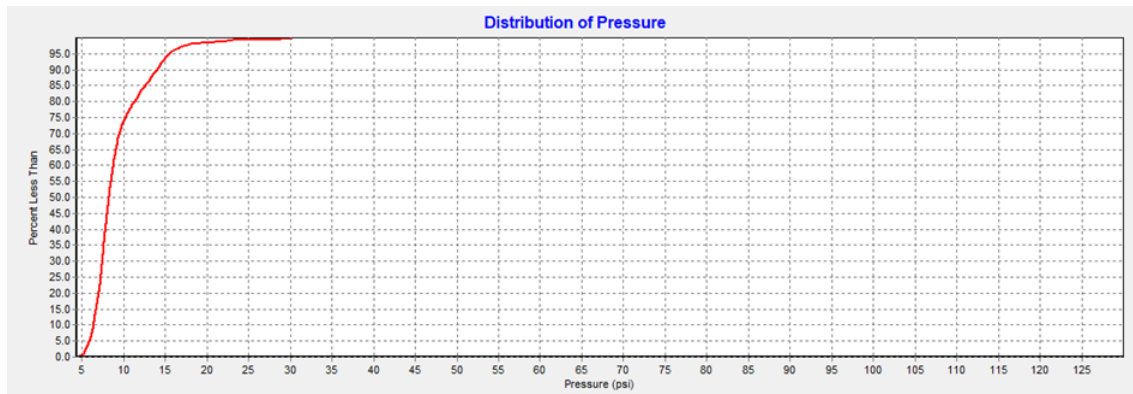

Note: Total flow is 72,096 gpm. It can be seen 70% of nodal pressures are < 10 psi.

**Figure 6-49:** MMI 8, nodal pressure distributions at end of Day 1, when all fires out, all trunk line repairs and 17 distribution line repairs are completed, and 94 remain.

Total economic loss due to loss of water services is therefore \$18.7 billion due to fire and \$276 million in economic loss, for a total of \$19 billion.

For MMI 9, stochastic analysis finds 205 distribution pipe and 14 trunk line repairs are required, with 59 ignitions. See Figure 6-50. Total flow is 94,296 gpm. Immediate impacts are:

- Virtually all nodal pressures are less than 10 psi so that Day 1 economic loss due to loss of water service \$162 million.
- All 59 fires have insufficient water and grow to be large fires, so that total fire loss is \$8.32 billion. However, even with perfect water supply, only 22 of these fires could have been responded to, so that only 22 fires equivalent to \$19.6 billion in losses should be attributed to loss of water supply, and the remainder of the loss (\$33 billion) to insufficient fire resources.

## NATURAL HAZARD MITIGATION SAVES:

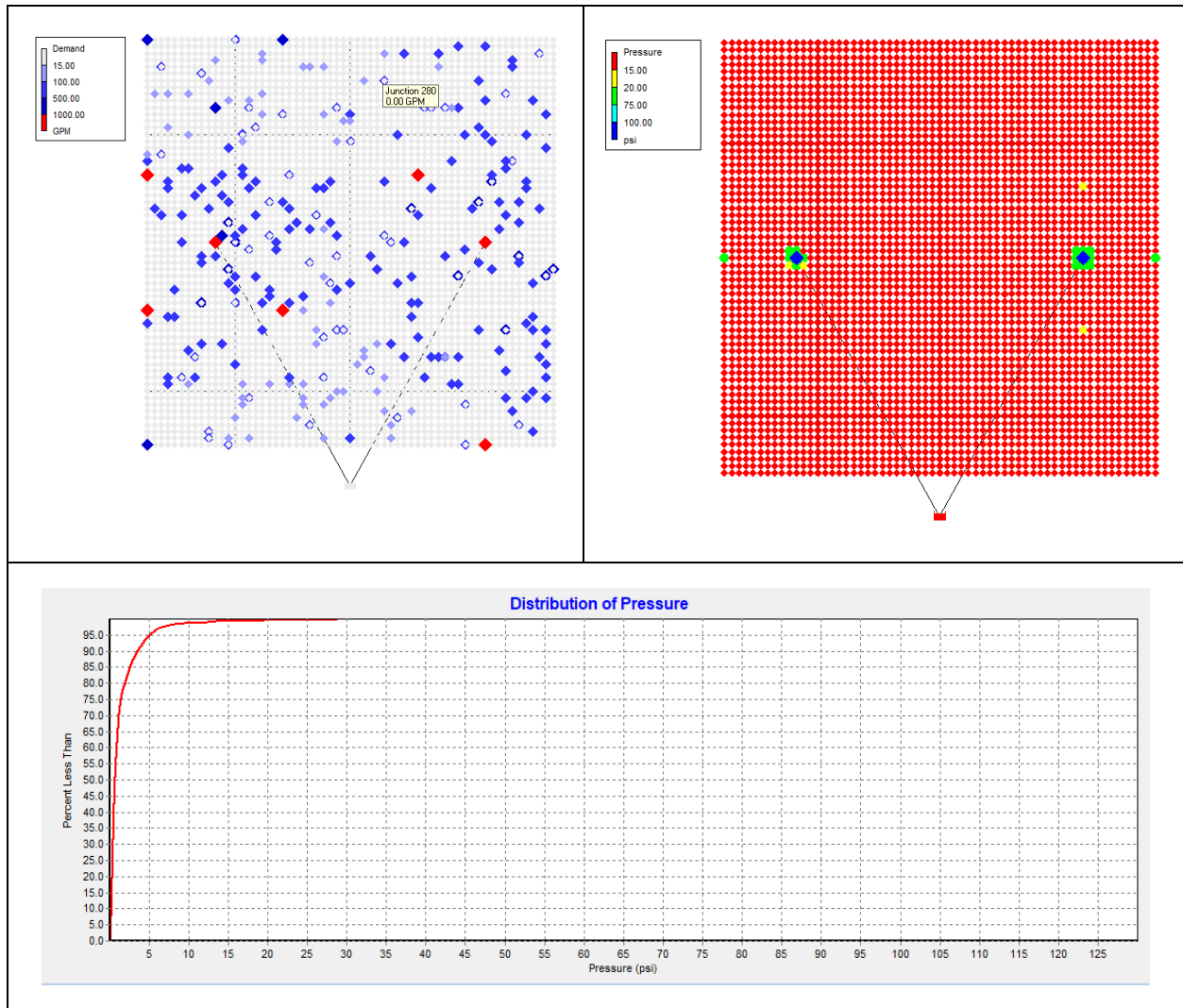

Note: All nodal pressures on Day 0 are below 20 psi. Total system flow is 94,296 gpm.

**Figure 6-50:** MMI 9, as-is design sustains 205 distribution and 14 trunk line repairs, and 59 ignitions occur.

At 24 hours after the event (i.e., end of Day 1), all fires are extinguished or burnt out, and all trunk line repairs and 7 distribution line have been completed. These repairs leave 95% of services still without water, resulting in \$154 million in economic loss. Day 2 sees 44 more distribution repairs, which still leaves 93% of services without water. Day 3 sees 54 more distribution repairs, but 80% of services are still without water. By Day 4, a total of 170 distribution repairs have been completed to date, and 100% of services are restored. By Day 5 all repairs are completed. Figure 6-51 shows this process. The total economic loss due to loss of service for the four days while service was being restored is \$596 million. The total economic loss due to fire given loss of water is \$19.6 billion, for a total loss attributable to loss of water of \$20.2 billion, and a total loss for all reasons of \$53.2 billion, mostly due to fire.



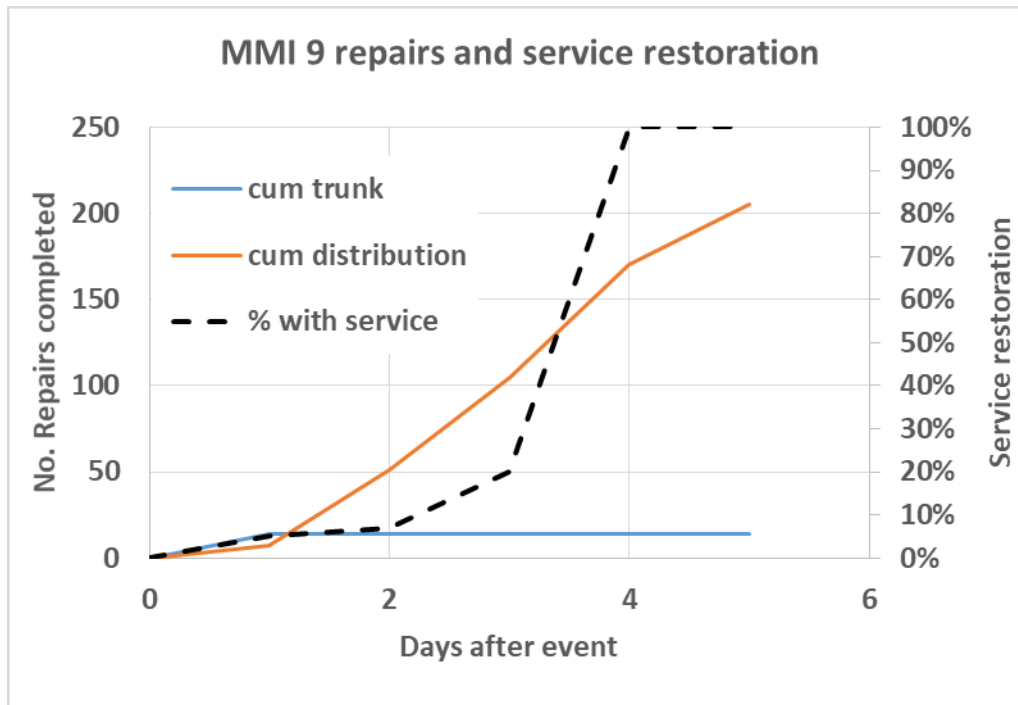

Figure 6-51: MMI 9, cumulative repairs and service restoration vs. days after event.

For MMI 10, stochastic analysis finds 371 distribution pipe and 31 trunk line repairs are required, with 170 ignitions. Total flow is 105,054 gpm. Plots of initial demand pressure distributions differ little from those for MMI 9, and are not shown here. Immediate impacts are:

- Virtually all nodal pressures are less than 10 psi so that Day 1 economic loss due to loss of water service is \$162 million.
- All 170 fires have insufficient water and grow to be large fires, so that total fire loss is \$152 billion. However, even with perfect water supply, only 22 of these fires could have been responded to, so that only 22 fires equivalent to \$19.6 billion in losses should be attributed to loss of water supply.

Completion of all repairs requires eight days, with all services restored by Day 7, so that the total economic loss due to loss of service for the seven days while service was being restored is \$1.13 million, and the total economic loss due to fire given loss of water is \$19.6 billion, for a total loss attributable to loss of water of \$20.8 billion, and a total loss for all reasons of \$153 billion, mostly due to fire. The foregoing results are summarized in Table 6-25.

Table 6-25: Results for as-is system for increasing seismic intensity.

	MMI 6	MMI 7	MMI 8	MMI 9	MMI 10					
Trunk (16") repairs	0	7	9	14	31					
Distribution (6") repairs	29	63	111	205	371					
Repairs per 1000 ft. of fall pipe	0.0059	0.0143	0.0245	0.0447	0.0821					
Total number of repairs	29	70	120	219	402					
Cost of repairs	\$ 0.11	\$ 0.32	\$ 0.53	\$ 0.94	\$ 1.72					
Initial flow (normal = 59,212 gpm)	68,680	73,386	74,817	94,296	105,054					
Initial flow (normal = 85 mgd)	98.9	105.7	107.7	135.8	151.3					
<b>Customers without service (Loss of Service, LOS, %) and economic loss (\$mills)</b>										
	% No	\$mills	% No	\$mills	% No	\$mills	% No	\$mills	% No	\$mills
LOS, Day "0"	0%	\$ -	85%	\$ 138	100%	\$ 162	100%	\$ 162	100%	\$ 162
LOS, Day 1					70%	\$ 113	95%	\$ 154	100%	\$ 162
LOS, Day 2							93%	\$ 151	100%	\$ 162
LOS, Day 3							80%	\$ 130	100%	\$ 162
LOS, Day 4									100%	\$ 162
LOS, Day 5									100%	\$ 162
LOS, Day 6									100%	\$ 162
Total customer-days LOS	0		191250		382500		828000		1575000	
mean LOS days (= tot cust-days/tot		-	0.850		1.700		3.680		7.000	
Total economic loss due to loss of water	\$ -	\$ -	\$ 138	\$ -	\$ 275	\$ -	\$ 596	\$ -	\$ 1,134	\$ -
<b>Fires and economic loss</b>										
Total ignitions	4		6		21		59		170	
Total no. large fires	0		0		21		59		170	
large fires due to loss of water	0		0		21		22		22	
economic fire loss   loss of water (\$mills)	\$ -	\$ -	\$ -	\$ -	\$ 18,732	\$ -	\$ 19,624	\$ -	\$ 19,624	\$ -
Total economic loss due to fire (\$mills)	\$ -	\$ -	\$ -	\$ -	\$ 18,732	\$ -	\$ 52,628	\$ -	\$ 151,640	\$ -
<b>Total economic loss   loss of water (\$mills)</b>	<b>\$ 0.1</b>	<b>\$ 138.0</b>	<b>\$ 19,007.9</b>	<b>\$ 20,221.1</b>	<b>\$ 20,759.7</b>	<b>\$ 53,224</b>	<b>\$ 152,774</b>	<b>\$ 152,774</b>	<b>\$ 152,774</b>	<b>\$ 152,774</b>
<b>Total economic loss (\$mills)</b>	<b>\$ -</b>	<b>\$ 138</b>	<b>\$ 19,007</b>	<b>\$ 53,224</b>	<b>\$ 152,774</b>	<b>\$ 152,774</b>	<b>\$ 152,774</b>	<b>\$ 152,774</b>	<b>\$ 152,774</b>	<b>\$ 152,774</b>

### 6.3.4. Vulnerability with Resilient Grid

The foregoing analysis allows easy assessment of a resilient grid by the project team. The analyst assumes the trunk line is resilient, rebuilt to have negligible vulnerability (as is currently assumed for ERDIP), and with automatic seismic valves that can quickly isolate the trunk line from the distribution system. The trunk line will now be integral and function immediately following an earthquake. It will (a) immediately be able to provide water for firefighting if the fire is within a relay-able distance, assumed here to be 1,000 ft. per engine<sup>34</sup>; (b) be able to convey potable water to within a few blocks of most of the population, which suffices for emergency conditions for a few days; and (c) greatly increase the restoration of service to many customers, since breaks in the distribution system will have a more limited impact. For these reasons, a low vulnerability trunk line system capable of being isolated from the more vulnerable distribution system constitutes a resilient grid. The project team thus assessed the reduction in loss resulting from benefits of the resilient grid.

For MMI 6, loss of service and the impact of fire was nil. The trunk line sustained no damage, so reduction in cost of repairs, and all benefits, are nil.

<sup>34</sup> Relay" here refers to the series deployment or "daisy-chaining" of fire engines, so as to serially pump water from a source to the fireground. A Class A fire engine is typically able to pump 1500 gpm 1,000 ft. through a 5 inch hose (termed Large Diameter Hose, LDH), which is within the capability of most urban fire departments (although the supply of LDH may be limited). Frictional loss in the hose is the limiting factor on distance and pressure.

## NATURAL HAZARD MITIGATION SAVES:

For MMI 7, 85% of the population lost service on Day 1, while losses due to the 6 fires was negligible. The benefit of water within a few blocks of 85% of the population is difficult to estimate; the cost of no water was estimated to be \$720 per service connection, so the project team assumed this limited emergency provision at selected points along the resilient grid is worth \$100 per customer connection, or a total of  $85\% \times 225,000 \times \$100 = \$19$  million.

For MMI 8, 55% of the 21 ignitions will be within a relay-able distance of 1,000 feet from the resilient grid, reducing the fire-related losses to \$8.4 billion for a benefit of \$10.3 billion. Losses due to loss of service to customers is estimated at  $\$620/\$720 \times \$275 = \$237$  million. Reduction in utility cost of repairs to trunk lines exists but is modest. Total benefits of the resilient grid are thus about \$10.5 billion.

For MMI 9, 55% of the 59 ignitions will be within a relay-able distance of 1,000 feet from the resilient grid, so that 22 of the ignitions can be prevented from becoming large fires, for a benefit of \$19.6 billion (although there are still \$33 billion in fire losses). Losses due to loss of service are \$513 million, or a reduction of \$83 million. Total benefits of the resilient grid are thus about \$19.7 billion.

Comparably, for MMI 10 the benefit of the resilient grid is \$19.8 billion. The above results are summarized in Table 6-26.

**Table 6-26:** Summary of losses and benefits with and without resilient grid given MMI shaking (\$ millions).

	6	7	8	9	10
Losses without resilient grid	\$-	\$138	\$19,007	\$53,224	\$152,774
Losses with resilient grid	\$-	\$119	\$8,667	\$33,517	\$132,993
Benefit of resilient grid	\$-	\$19	\$10,341	\$19,707	\$19,782
Cost of resilient grid	\$403	\$403	\$403	\$403	\$403
Benefit-cost ratio	0	0.05	25.7	48.9	49.1

### 6.3.5. Results

The as-is system consists of 4.39 million feet of 6-inch distribution pipe and 504,000 feet of 16-inch trunk line pipe, with a replacement value at \$50 per inch-feet of \$1.32 billion and \$403 million, respectively. This system provides potable and firefighting water for a study region with a population of 787,500 and value of \$100.8 billion.

Benefits of a resilient grid are defined as reduction in losses attributable to the resilient grid, which are determined as fire losses and economic losses due to loss of service for the as-is system, minus those for the system with a resilient grid. These are summarized in Table 6-26 for selected levels of seismic intensity, and are seen to increase with increasing seismic intensity. It should be noted that these benefits are conditioned on the occurrence of the event.

## NATURAL HAZARD MITIGATION SAVES:

Annual frequency of seismic intensity is inversely correlated and varies by location in the United States, as can be seen Figure 6-52 for several West Coast cities.

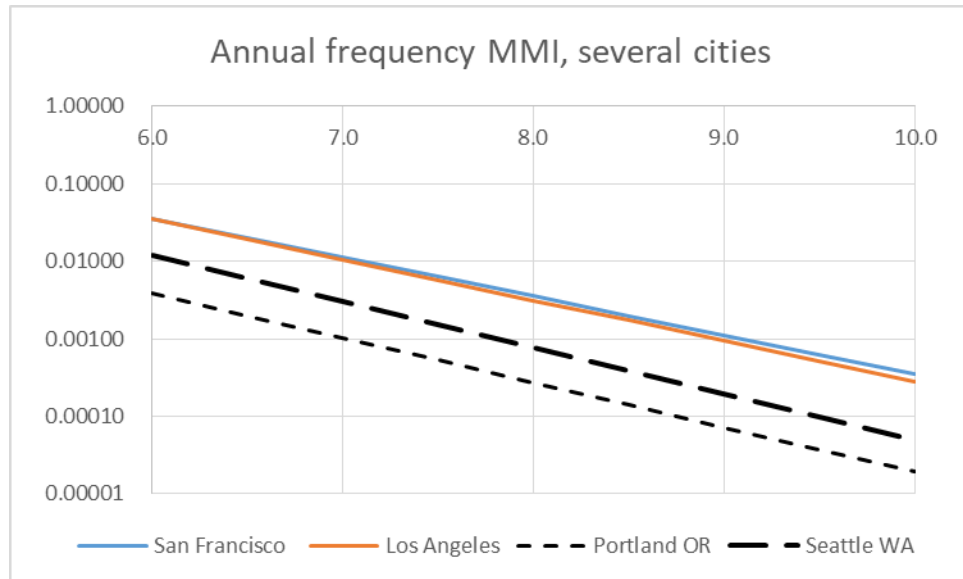

Figure 6-52: Annual frequency of MMI for Los Angeles, San Francisco, Portland and Seattle, Vs 300 mps.

Given these intensity curves and the benefit data (interpolated linearly between integer values of MMI), the project team numerically integrate to determine the benefit per annum,  $B_{pa}$ , attributable to a resilient grid:

$$B_{pa} = \sum_{MMI=6}^9 B(MMI)f(MMI)\Delta MMI$$

Equation 6-14

where  $B(MMI)$  is the benefit as a function of  $MMI$ ,  $f(MMI)$  it is the annual frequency of  $MMI$ , and  $\Delta MMI$  is the  $MMI$  interval employed in the numerical summation. This calculation was performed four West Coast cities using ground motion annual frequency data obtained from OpenSHA San Francisco and Los Angeles, and Peak Ground Acceleration (PGA) for Portland and Seattle obtained from USGS national seismic hazard maps. This data was converted to MMI using Wald et al. (1999). The present value of all future benefits  $PV(B)$  is then:

$$PV(B) = \int_0^T B_{pa} e^{-lt} dt$$

Equation 6-15

where  $l$  is the cost-of-borrowing discount rate per annum, and  $T$ , the time horizon of interest, was taken as 100 years. Using these values and integrating benefits and annual frequency of occurrence of  $MMI$ , the project team found the present value of all future benefits for the hypothetical study region sited so as to

have the seismic hazard of several West Coast cities. Dividing the present value of all future benefits by the replacement value of the resilient grid (which assumes the existing trunk lines are rebuilt with ERDIP pipe and seismic isolation valves), the project team determined the benefit-cost ratio, *BCR*:

$$BCR = PV(B) / \text{replacement cost}$$

### Equation 6-16

This has been done for the four West Coast cities using a cost-of-borrowing discount rate of 2.2%, as shown in Table 6-27. The higher seismic hazard locations of San Francisco and Los Angeles have BCRs of about 6 to 8, Seattle 1.7 and Portland less than 1. Table 6-28 shows BCRs for discount rates of 2.2%, 3% and 7%, from which it can be seen that resilient grids are clearly cost-beneficial for cities in high to very high seismic regions (i.e., Seattle, San Francisco and Los Angeles) but may not be cost-beneficial for a moderate region such as Portland.

However, it should be noted that these BCRs are all based on long-term seismic hazard probabilities and not time-dependent probabilities. All four cities are judged to be at high risk of a major earthquake in the near term, which if taken into account would increase the BCRs significantly.

**Table 6-27:** Summary of benefits and BCR, four West Coast cities (cost-of-borrowing discount rate of 2.2%).

	San Francisco	Los Angeles	Portland OR	Seattle WA
Benefit per annum, $B_{pa}$ (\$ million)	\$82.1	\$62.27	\$5.85	\$17.10
$PV(B)$ (\$million)	\$3,340	\$2,534	\$238	\$696
Replacement value resilient grid (\$ million)	\$403	\$403	\$403	\$403
Benefit-cost ratio, $BCR$	8.3	6.3	0.6	1.7

### 6.3.6. Summary and Conclusions

The project team examined the benefits of an urban water distribution resilient grid concept using an idealized study region that was representative of a typical mid-sized U.S. city. The study region is modeled as a buried water distribution network consisting of a 600 feet rectangular grid of 6-inch diameter distribution pipes, with 16-inch trunk lines spaced every tenth distribution pipe. This sizing was selected so as to provide adequate potable and firefighting demands for the study region, and is representative of an urban water grid. The grid is fed from supplies arriving at two relatively central points on the trunk line grid, typical of terminal reservoirs.

The examined stress event, earthquake, affects the grid in two ways: (a) the earthquake causes numerous leaks and breaks (collectively termed repairs) by shaking and ground failure, and (b) the earthquake also causes fires to ignite due to the shaking, which create extraordinary fire flow demands on the system.

## NATURAL HAZARD MITIGATION SAVES:

Modeling follows accepted guidelines for pipe repairs (ALA 2001) and post-earthquake ignitions, fire growth, and fire flow demands (SPA Risk 2009; Technical Council for Lifeline Earthquake Engineering 2005). PGD effects are modeled as a simple increase in repair rates averaged over the entire system, rather than focused in a few areas of the network.

Given these demands, the network is hydraulically analyzed in a PDA mode using EPANET (Rossman 2000) to determine the network capacity vis-à-vis these demands. As summarized in Table 6-25, repairs and ignitions vary from 29 repairs and 4 ignitions for MMI 6, to 402 repairs and 170 ignitions at MMI 10, with losses increasing from about nil at MMI 6 to \$153 billion at MMI 10, dominated by fire losses. Because the fire service is overwhelmed after approximately 22 ignitions, only a portion of the fire losses should be attributed to a water system lack of capacity, so that water-related losses are capped at approximately \$20 billion for fire, while losses due to lack of potable supply continue to increase at a more modest rate. Thus, water system related losses approximate nil at MMI 6 to \$20.7 billion at MMI 10. All of these losses are for the as-is system, without a resilient grid; that is, repairs are required to both the distribution and trunk lines.

The resilient grid concept involves replacement of the trunk lines with low-vulnerability pipe, such as is currently available by ERDIP type pipe. The resilient grid then is considered not significantly damaged by earthquake, and isolated from the damaged distribution network by seismically-actuated valves. Such valves are quite feasible. For example, they have been employed on the San Francisco Auxiliary Water Supply System since the 1990s. The resilient grid has a 6000 feet spacing so that, combined with hose lays by the fire service, it brings potable supply to within 3000 feet of all customers, thus providing firefighting water supply at 55% of the ignitions. In this manner, fire losses are significantly reduced, especially at moderate MMI intensities (i.e., 6~8) and potable water supply is significantly improved. While not quantified, it is quite likely that only a few repairs to the distribution system, combined with the resilient grid, would allow quick re-establishment of water supply to large numbers of customers in selected portions of the grid.

Using conservative estimates of the benefits accruing to the resilient grid, and taking the cost of the resilient grid as full replacement of all existing trunk lines, benefits are determined, and range from approximately nil at MMI 6 to \$20 billion at MMI 10. Applying annual frequencies of these intensities for four West Coast cities, the project team found that the resilient grid has a BCR of about 6 to 8 for seismic environments typical of Los Angeles and San Francisco, a value of 1.7 for Seattle and 0.6 for Portland, based on a cost-of-borrowing discount rate of 2.2%. If higher discount rates are employed, these BCRs decline, for a discount rate of 3%, to 5 to 6 for Los Angeles and San Francisco, and 1.3 and 0.5 for Seattle and Portland, respectively, and for a discount rate of 7%, to 2 to 3 for Los Angeles and San Francisco, and 0.6 and 0.2 for Seattle and Portland, as summarized in Table 6-28.

**Table 6-28:** Summary of resilient watergrid BCRs for several discount rates, four West Coast cities.

Discount rate (pa)	San Francisco	Los Angeles	Portland OR	Seattle WA
2.2%	8.3	6.3	0.59	1.73
3.0%	6.4	4.9	0.46	1.34
7.0%	2.9	2.2	0.21	0.61

In summary, the resilient grid concept is cost beneficial in high to very high seismic regions (i.e., Seattle, San Francisco, and Los Angeles). These BCRs are based on long-term seismic hazard probabilities. Since all four cities are judged to be at high risk of a major earthquake in the near term, if time-dependent hazard probabilities are taken into account, the BCRs would increase significantly. Observations include:

- The major benefit of the resilient grid is due to improved supply of firefighting water.
- The benefit of the resilient grid is constrained by the capacity of the fire service. For the study area, this plateaus at about 22 ignitions. If the fire service can increase its capacity, for example, by having a greater capacity to move water via tanker trunks or portable water supply systems, then the resilient grid is much more beneficial.
- The above observation reinforces the point that the resilient grid concept is not solely a water department initiative, but would need to be pursued in close cooperation with the fire service.
- Irrespective of the fire aspect, however, the resilient grid is quite likely to result in significantly reduced time to restoration of water supply to customers.
- Closer spacing of the resilient grid may not significantly increase the BCR. That is, while closer spacing (e.g., trunk lines at every fifth or sixth distribution line, rather than every tenth) increases benefits, it also increases costs. If the trunk line spacing is every tenth distribution line for example, then the cost of a resilient grid is more than \$800 million. Calculation of BCRs for closer (or more sparse) trunk line spacing was not performed in detail, but examination of the results for the 1 to 10 spacing of the study region indicates that the BCRs would in fact remain about the same if the spacing were made 1 to 5.
- The above findings on BCRs are based on the conservative assumption that the resilient grid requires the replacement of 100% of the trunk lines, which is probably overly conservative. If, alternatively, it is assumed that only a portion of the resilient grid requires replacement (e.g., say 50% of the existing trunk lines are considered of low vulnerability), then the above BCRs are doubled.

In conclusion, based on a limited examination of an idealized study region representative of a mid-sized U.S. city, the concept of a resilient grid is clearly cost-beneficial for high seismicity regions. Future studies might examine the resilient grid for other types of stress events, such as flooding or tropical cyclones.

## 6.4. BENEFIT-COST ANALYSIS OF A RESILIENT ELECTRIC GRID

### 6.4.1. Purpose and Focus

The purpose of this sub-task to examine the benefits and costs of achieving electric power grid resilience. As noted in the *Quadrennial Energy Review* of the Department of Energy (DOE 2017), “The reliability of the electric system underpins virtually every sector of the modern U.S. economy.” Note that quotations in this section are from DOE (2017) unless otherwise noted.

Electric power is not only important in itself, it also underpins virtually all other infrastructure and economic activity, as shown in Figure 6-53. This importance has been underscored in very large blackouts, which have affected tens of millions of people. Examples include the 2012 blackout in India, which affected 700 million, and the 2003 U.S. Northeast Blackout, which affected 50 million (Duddu 2015). Such blackouts have typically been due to overload or equipment failure rather than extreme external events, such as hurricanes or earthquakes, although extreme events are a significant cause. See Table 6-29.

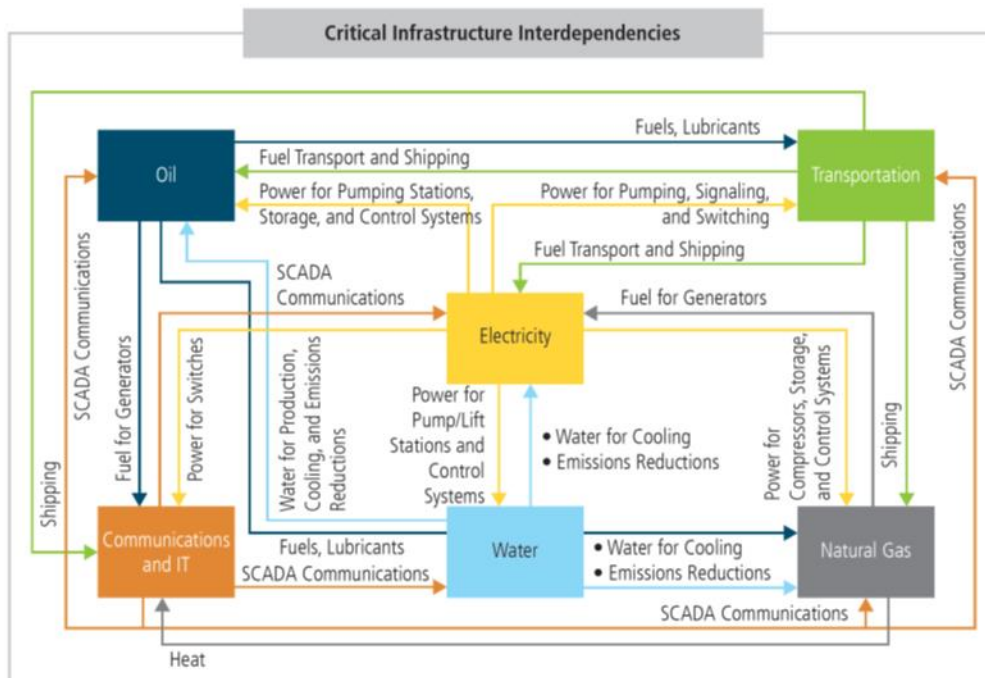

Figure 6-53: Importance of electric power and critical infrass dependencies (DOE 2017).



**Table 6-29:** Blackout initiating events NERC data 1986-2003, from (Hines et al. 2008).

Cause	Percent of events	Mean size (MW)	Mean size (customers)
Earthquake	0.8	1,408	375,900
Tornado	2.8	367	115,439
Hurricane/tropical storm	4.2	1,309	782,695
Ice storm	5	1,152	343,448
Lightning	11.3	270	70,944
Wind/rain	14.8	793	185,199
Other cold weather	5.5	542	150,255
Fire	5.2	431	111,244
Intentional attack	1.6	340	24,572
Supply shortage	5.3	341	138,957
Other external cause	4.8	710	246,071
Equipment failure	29.7	379	57,140
Operator error	10.1	489	105,322
Voltage reduction	7.7	153	212,900
Volunteer reduction	5.9	190	134,543

Regarding measuring resilience, "... a number of resilience metrics and measures have been proposed; however, there has not been a coordinated industry or government initiative to develop consensus or implement standardized resilience metrics", so that this study employs the decrease in expected service outage as a measure of resilience, together with the associated decreases in economic losses. A significant contributor to resilience is grid reliability: "Reliability of the grid is a growing and essential component of national security... [and]...Standard definitions of reliability have focused on the frequency, duration, and extent of power outages" and have not considered in a systematic manner the potential for widespread long-duration outages due to major natural disasters.

Note that DOE (2017) defines and measures reliability as "the ability of the system or its components to withstand instability, uncontrolled events, cascading failures, or unanticipated loss of system components. Resilience is the ability of a system or its components to adapt to changing conditions and withstand and rapidly recover from disruptions...A brief review of how reliability is measured today will help ... reliability is formally defined through metrics describing power availability or outage duration, frequency, and extent...One metric applied with the goal of improving system performance with respect to reliability indicators is the System Average Interruption Duration Index (SAIDI). SAIDI measures the total duration of an interruption for the average customer given a defined time period.....As most outages occur on the distribution system rather than the bulk power system, these reliability indices are commonly used to measure distribution level reliability. NERC [National Electric Reliability Corporation] uses a number of bulk

## NATURAL HAZARD MITIGATION SAVES:

power system reliability indices...utilities have historically reported SAIDI ... statistics in inconsistent ways... only 33 percent of utilities report these statistics, covering 91 percent of the electricity sales in the Nation, which indicates that there is room for improving reliability reporting practices.” Note that other metrics of electric system performance exist, and they too are often reported inconsistently.

The electric power grid is complex, with multiple types of electric generation and storage, and transmission and distribution to the end user, as schematically depicted in Figure 6-54. These elements are subjected to a number of threats, as shown in Figure 6-55, from which it can be seen that one of the more critical elements of the system are substations. This is emphasized in Figure 6-56, which shows that substations are probably the most crucial element of the electric power system, due both to their vulnerability as well as the topology of the grid (multiple sources and transmission paths, but multiple paths converging at substations).

It should be noted that the electric power system is evolving and a new grid is emerging with more controllability (“With the advent of more two-way flows of information and electricity—communication across the entire system from generation to end use, controllable loads, more variable generation, and new technologies such as storage and advanced meters—reliability needs are changing...”) as well as more end-user, close-in generation (e.g., photovoltaic). However, the system model used here (source-transmission-substation-distribution-end-user) is what currently exists, and will exist for a significant period going forward.

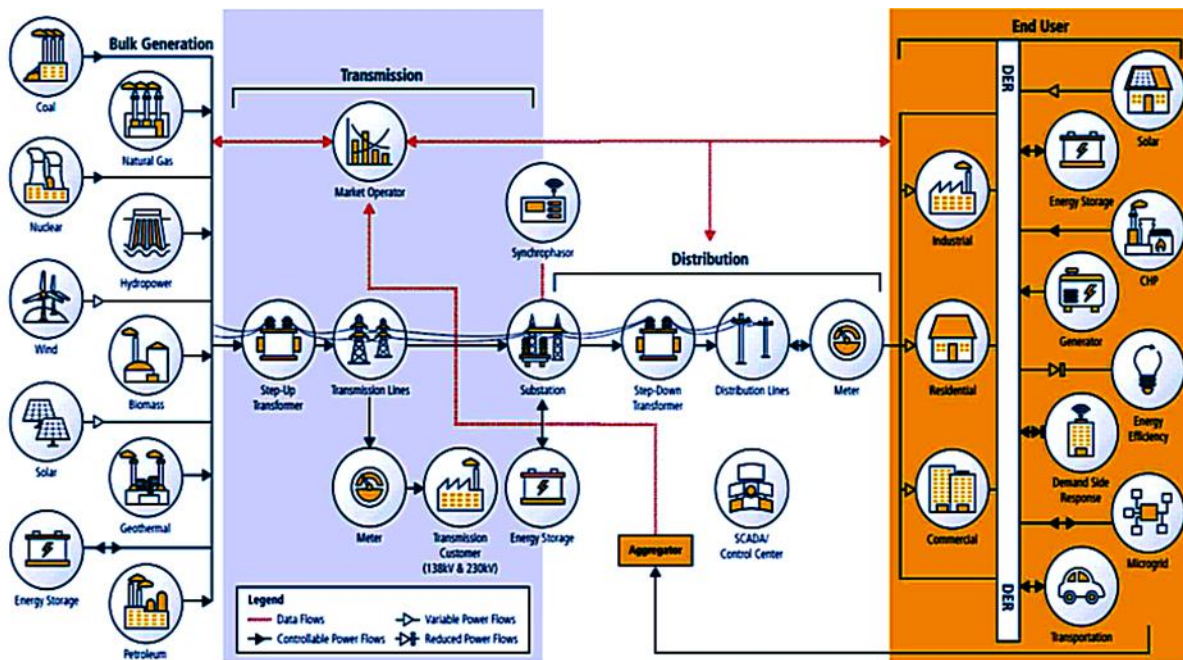

Figure 6-54: Schematic representation of the U.S. electric power system. (Adapted from DOE 2017)

# NATURAL HAZARD MITIGATION SAVES:

Threat	Intensity	System Components					
		Electricity Transmission	Electricity Generation	Electricity Substations	Electricity Distribution (above)	Electricity Distribution (below)	Storage
<b>Assessment of Risk &amp; Resilience</b>							
<b>Natural/Environmental Threats</b>							
Hurricane	Low (<Category 3)	●	●	●	●	●	●
	High (>Category 3)	●	●	●	●	●	●
Drought	Low (PDSI>-3)	●	●	●	●	●	●
	High (PDSI<-3)	●	●	●	●	●	●
Winter Storms/Ice/Snow	High (PDSI<-3)	●	●	●	●	●	●
	Low (Minor icing/snow)	●	●	●	●	●	●
Extreme Heat/Heat Wave		●	●	●	●	●	●
Flood	Low (<1:10 year ARI)	●	●	●	●	●	●
	High (>1:100 year ARI)	●	●	●	●	●	●
Wildfire	Low (>Type III IMT)	●	●	●	●	●	●
	High (Type I IMT)	●	●	●	●	●	●
Sea-Level Rise		●	●	●	●	●	●
Earthquake	Low (<5.0)	●	●	●	●	●	●
	High (>7.0)	●	●	●	●	●	●
Geo-magnetic	Low (G1-G2)	●	●	●	●	●	●
	High (G5)	○	●	●	●	○	●
Wildlife/Vegetation		●	●	●	●	●	●
<b>Human Threats</b>							
Physical	Low	●	●	●	●	●	●
	High	●	●	●	●	●	●
Cyber	Low	●	●	●	○	○	○
	High	○	○	○	○	○	○
Electro-magnetic	Low (Ambient EMI)	●	●	●	●	●	●
	High (NEMP & HEMP)	●	○	○	●	●	○
Equipment Failure		●	●	●	●	●	●
Combined Threats		○	○	○	○	○	○

<b>Levels of Risk</b>		<b>Current Status of Risk Management Practice</b>		
○ Low	● High	○ Nascent: critical vulnerabilities exist		
● Moderate	○ Unknown	● Established, but opportunities for improvement remain		
		● Well-established and robust		

Figure 6-55: Risks to electricity sector resilience from current threats. (DOE 2017)

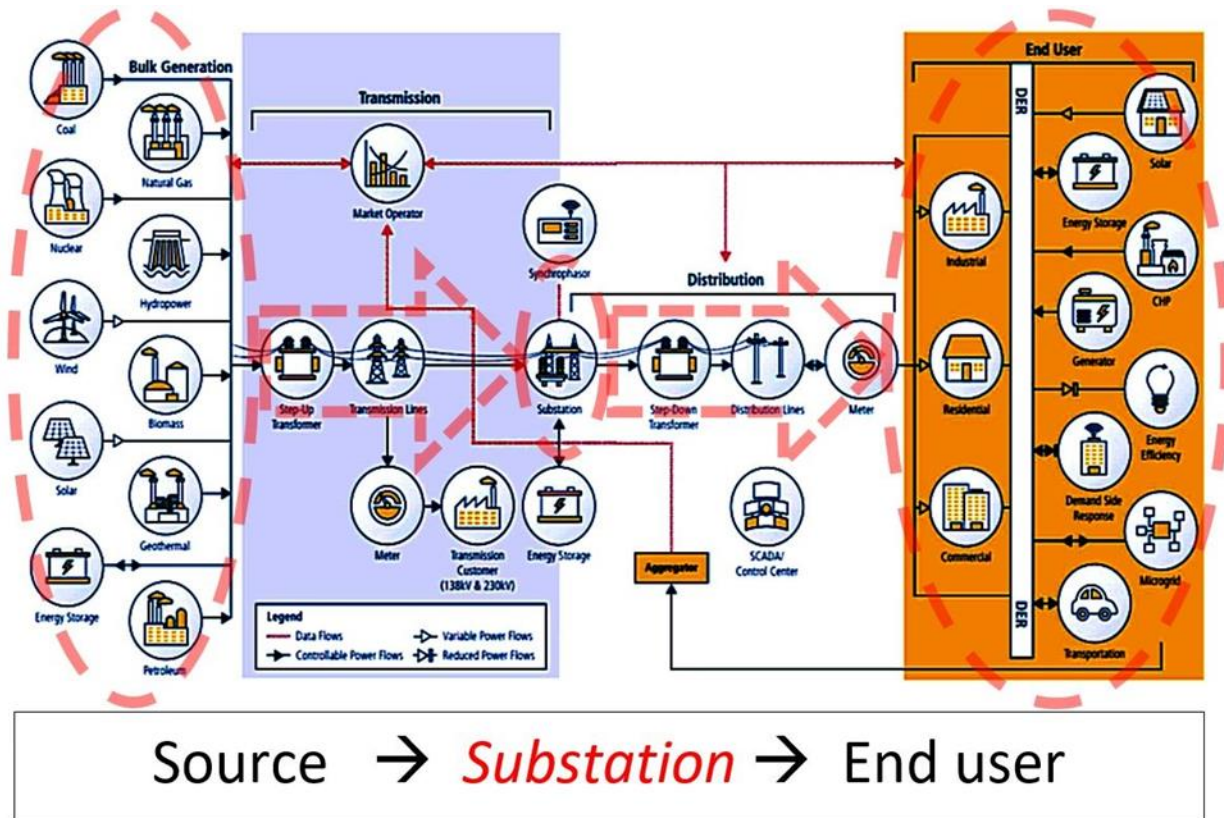

Figure 6-56: Schematic representation of the U.S. electric power system showing EHV substations as a critical link. Adapted from DOE (2017).

- Electric power systems, and substations in particular, are vulnerable to earthquakes. Examples of the impacts of earthquakes on electric power systems are given in (Romero et al. 2015):
- On January 17, 1994, the Northridge Earthquake struck the city of Los Angeles and surrounding areas; 2.5 million customers lost power. (Dong et al. 2004)
- On January 17, 1995, the Great Hanshin Earthquake occurred in 1995, affecting the city of Kobe, Japan, where 20 fossil-fired power generation units, six 275-kV substations, and two 154-kV substations were damaged; approximately 2.6 million customers were affected by outages. (Noda 2001)
- On May 18, 2008, the Winchman Earthquake caused extensive damage to local power transmission and distribution systems in Sichuan Province, China; approximately 900 substations and 270 transmission lines of the State Power Grid were damaged. (Didinger 2009)
- Immediately following the February 27, 2010, 8.8-MW Chilean Earthquake, 90% of Chileans did not have electricity, which caused the largest power transmission company in Chile to have direct losses of approximately U.S. \$6.5 billion. (Long 2010)
- On March 11, 2011, the devastating Tohoku Chino–Taiheiyo–Oki Earthquake, damaged 14 power plants, 70 transformers, and 42 transmission towers, and caused other failures. Outages affected 4.6 million residences, and the April 7 aftershock affected an additional 4 million. (Shubuta 2011)

Regarding seismic vulnerability of electric substations, there is extensive literature on the performance of substation components (ASCE 1999, Fujisaki 2009, Hosseini 2009, Hosseini et al. 2009, Knight and Kempner 2009) and several guidelines and standards for seismic design (ASCE 1999, IEEE 693 2005). Retrofitting has also been dealt with (Knight and Kempner 2009, Romero et al. 2015, Oikonomou et al. 2016), with some investigations of benefits (Neudorf et al. 1995, Shumuta 2004, Han et al. 2007), but costs of retrofitting substations do not explicitly appear in the literature and there is little to no quantification of BCRs (e.g., Neudorf et al. 1995, who seek the minimum cost alternative, not the BCR).

Given the above knowledge gaps, the focus of this study then is the benefit versus cost of reducing the vulnerability of electric substations and the impact of this vulnerability on service outage. The project team examined the hazard of earthquake, with two conditions: substations with standard (i.e. non-seismically designed) components, versus a substation with seismically designed components. Benefits are the decrease of direct damage and costs of service outage given seismically designed components. Cost is the financial burden of retrofitting substation components.

### 6.4.2. Electric Power Grid and Substations Vulnerability

High voltage (H, 138 kV and greater) and extra high voltage (EHV, 345 kV and greater) electric transmission lines are shown in Figure 6-57 overlaid on NERC regions, with substations overlaid on Core-Based Statistical Areas (CABS, greater than 100,000 population) in Figure 6-58. Reviewing these two figures, it can be seen that major power imports to urban areas pass through a number of large substations, failure of which would disrupt service to major population centers. Analysis of this data shows that in urban areas, high voltage substations on average serve 30,000 customers, with a substation spacing of about 7 km.

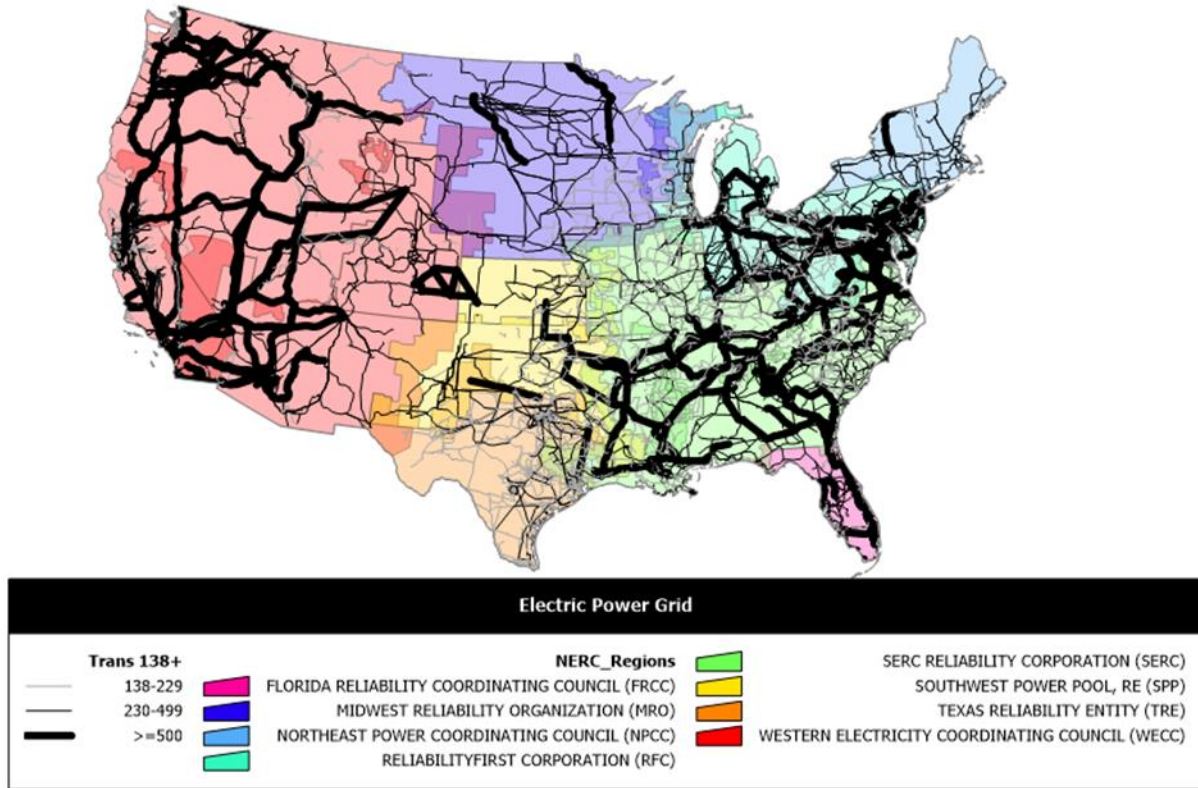

Figure 6-57: Electric transmission (138 kV and greater) overlaid on NERC regions.

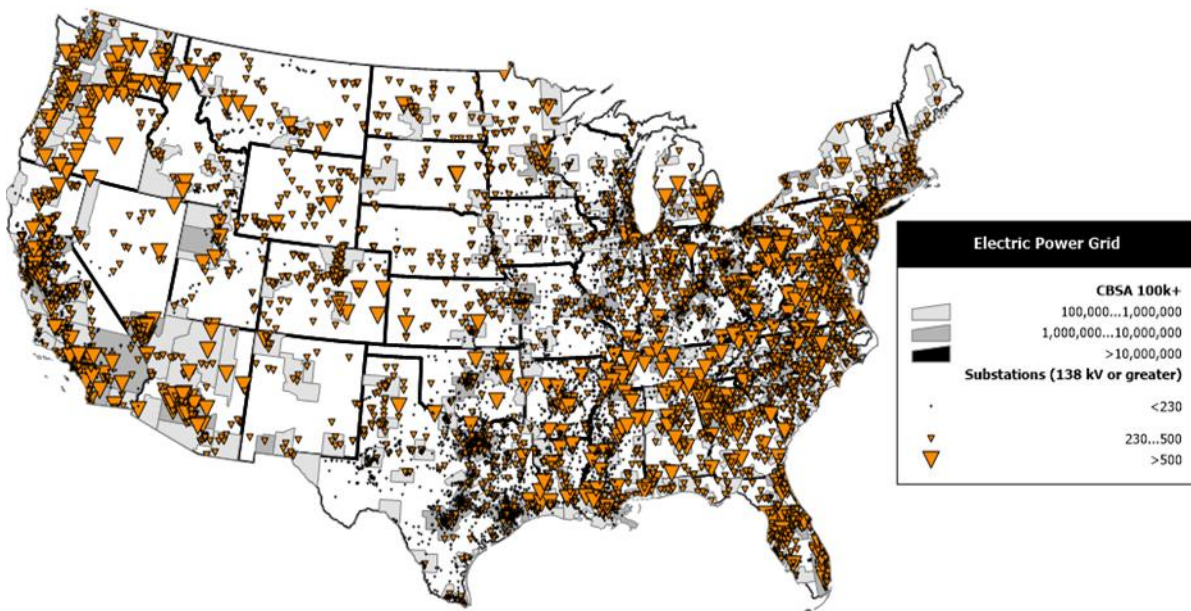

Figure 6-58: Substations (138 kV and larger voltage) overlaid on CBSAs, greater than 100,000 population.

H and EHV substations serve two basic purposes: switching (i.e., opening and closing circuits) and transforming voltage (e.g., from higher to lower voltage). Switching is inherently required in transmission

## NATURAL HAZARD MITIGATION SAVES:

and distribution of electric power via networks, while voltage is transformed at the generator to higher voltage for transmission, and then must be reduced (or stepped down) close to load centers for use at lower voltages. Within the fence of a substation is typically a network of overhead bus (rigid or flexible) which connects switches, circuit breakers, transformers and other equipment, and sometimes a small building housing monitoring and control equipment. See Figure 6-59. Switches are required for routing electricity as well as isolating equipment to protect against overload as well as for maintenance. HV and EHV transformers are typically large, heavy (100 tons and more) equipment that historically are supported on a concrete pad without sufficient attachment for earthquake lateral loading (Kempner Jr. 2008). Large ceramic bushings on the transformers also are vulnerable to seismic loading. Retrofitting of substations typically involves providing sufficient anchorage for transformers and other equipment (occasionally, base isolation is employed), use of more seismically resistant bushings, and allowance for differential movement of bus and equipment under lateral loading. Control buildings, if present, are strengthened. Of these measures, perhaps the most crucial, as well as cost-driver, is the anchorage of transformers (Romero et al. 2015).

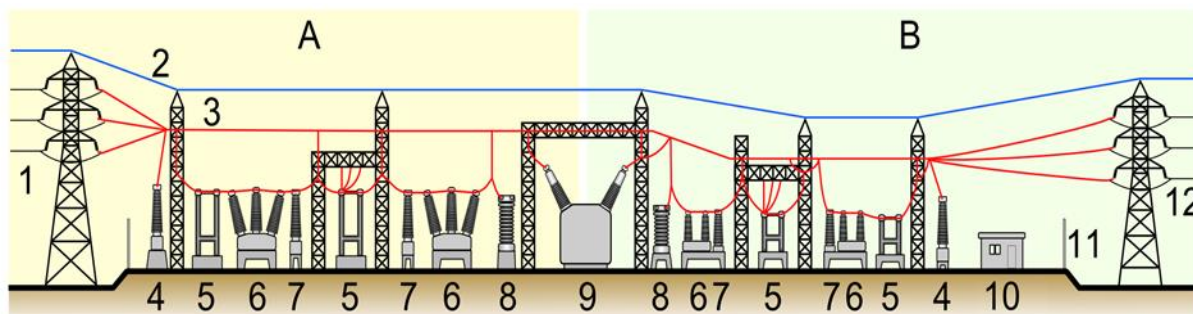

Figure 6-59: Substation schematic.

Figure 6-60 shows the threat to major urban substations in California by overlaying their locations on a map of a 2% in 50 years probability of PGA exceedance. It can be seen that many substations are subject to a very high seismic hazard. Values for vulnerability of substations are available from various sources (Anagnos and Ostrom 2000, DHS 2003, Federal Emergency Management Agency 2003, Kempner Jr 2008, Fujisaki 2009, Kempner Jr. 2009, Knight and Kempner 2009). In this study, the project team used substation fragility and outage duration data from Federal Emergency Management Agency (2003), Figure 6-61 for example shows the probability of a substation being in the complete damage state for a substation with (U) unanchored equipment, with anchorage designed for a PGA of 0.47g and for a PGA of 1g. Complete damage is defined by FEMA (2003) as the “failure of all disconnect switches, all circuit breakers, all transformers, or all current transformers, or by the building being in complete damage state.” Other damage states are minor, moderate and extensive. Table 6-30 presents the Hazus estimate of the parameters of substation fragility and restoration time for each damage state.

**Table 6-30:** Fragility and median duration of outage, high voltage substations (FEMA 2003).

Damage state	Unanchored				Anchored			
	Min	Mod	Ext	Compl	Min	Mod	Ext	Compl
Median PGA (g)	0.09	0.13	0.17	0.38	0.1	0.15	0.2	0.47
$\beta$	0.5	0.4	0.35	0.35	0.5	0.45	0.35	0.4
Median duration outage (days)	1	3	7	30	1	3	7	30

Using this data, a substation subjected to 0.2g PGA and having unanchored equipment will on average be out of service for about 6.1 days, while if anchored to a design PGA of 0.47g, the outage will be about 4.8 days, or a net benefit of the anchoring of about a 1.3 days' reduction in outage. If the anchorage is designed for a PGA of 1g, the outage is perhaps half a day and the net benefit about a 5.6 days' reduction in outage.

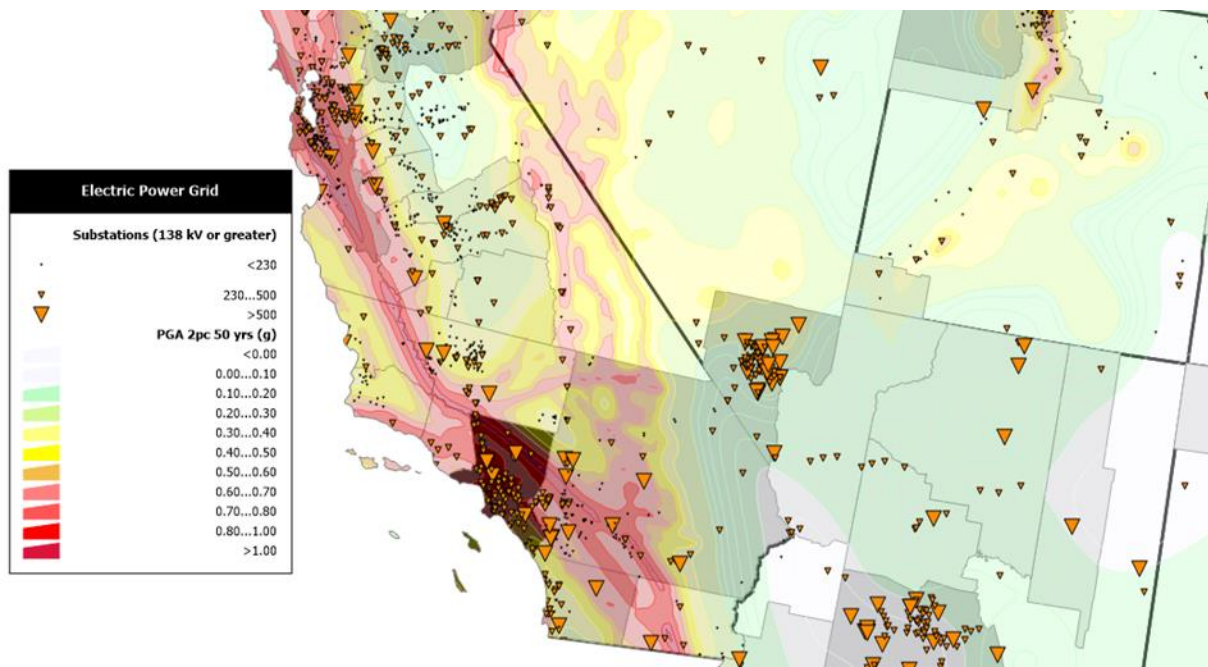

**Figure 6-60:** Substations (138 kV and larger voltage) overlaid on CBSA and peak ground acceleration (PGA, 2% probability of exceedance in 50 years), southwestern United States.



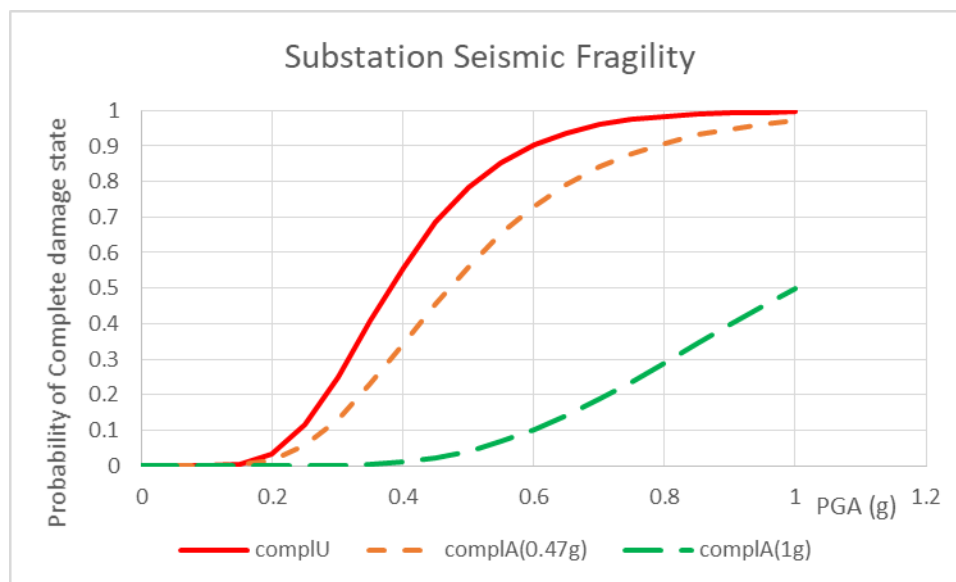

Figure 6-61: Substation seismic fragility – probability of Complete damage state if unanchored (U), anchored (A) to 0.47g design, and anchored to 1.0g design.

### 6.4.3. Impacts of Loss of Electric Power

The difference in electric power outage is a measure of the benefit of the resilient grid, which can more specifically be quantified in terms of reduced losses in several categories.

#### 6.4.3.1. Substation Repair and Retrofitting Costs

Assuming no ground failure, substation repair costs are dominated by damage to large equipment items, particularly large transformers. High voltage transformers typically cost between \$5 and \$10 million each (DOE 2012) and a typical substation will have a minimum of three such transformers, so that a minimum value of a substation with all associated equipment will be on the order of \$20 to \$ 50 million (replacement value of equipment only). Using an average HV substation equipment replacement value of \$40 million and Hazus vulnerability data, a substation subjected to 0.2g PGA and having unanchored equipment will on average sustain repair costs equivalent to about 56% of replacement value or \$22 million, while if anchored to a design PGA of 0.47g, the loss is about \$18 million, or a net benefit of the anchoring of about \$4 million. If the anchorage and equipment are designed for a PGA of 1g, the loss is about \$1 million and the net benefit about \$21 million.

Data on the costs to provide this anchorage are sparse. Based on review of proprietary utility data, as well as some limited data available from this study’s review of the FEMA database, a value of \$5 million per substation is assumed for seismic retrofit.

#### 6.4.3.2. Economic Losses Resulting from Loss of Electric Service

Economic losses resulting from loss of electric service include:

## NATURAL HAZARD MITIGATION SAVES:

- Direct damage and losses (e.g., food spoilage)
- Direct BI due to loss of electric service (e.g., loss of ticket sales at an amusement park), and
- Indirect BI losses to the rest of the economy that does business with customers who lose electric service (e.g., loss of parking revenue due to closure of the amusement park).

Numerous studies have been conducted on the economic impacts of blackouts, although almost all address non-disaster caused blackouts of relatively short duration, such as the 2003 Northeast Blackout (Tiedemann and Hydro, LaCommare and Eto 2006, Rose et al. 2007a, Küfeoğlu and Lehtonen 2015, Larsen et al. 2017). The outages addressed in these studies are typically less than a day and more typically an hour, so that they have little direct relevance to this study. An exception is (Rose et al. 2007b), from which a current (2018) value of disruption of about \$146 per capita per day emerges, for BI only. An alternative approach used here is as follows based on a hypothetical outage in California:

- LTEWA = total weighted average time element loss per day per person who lives in the area affected by loss of power =  $(1+Q) \times \text{LDTEWA}$
- Q = indirect time element loss as a factor of direct time element loss, from *2017 Interim Report* = 0.5
- LDTEWA = weighted average direct time element loss per day per person who lives in the area affected by loss of power =  $\text{LDBIW} \times (\text{total number of California firms}) / (\text{total California population}) + \text{LALER}$
- LDBIW = loss per day from direct business interruption for workplaces, per workplace =  $(\text{total California gross state product}) / ((\text{total number of California firms}) \times 365)$
- LALER = loss per day from additional living expenses for homes, per resident

Using the following data:

- Total California population<sup>35</sup> = 39,536,653
- Total number of California employer establishments<sup>36</sup> = 922,477
- Total number of California non-employer establishments<sup>37</sup> = 3,206,958
- Total number of California firms = total number of California employer establishments + total number of California non-employer establishments =  $922,477 + 3,206,958 = 4,129,435$
- California gross state product<sup>38</sup> = \$2,746,873,000,000
- GSA per diem for meals & incidental expenses, not including accommodations<sup>39</sup> = \$64

Then LALER = \$64, Total number of California firms = 4,129,435, LDBIW = \$1,822, LDTEWA = \$254, Q = 0.5 and LTEWA = \$381. This approach results in an estimate of about 2.6 times that of (Rose et al. 2007a). Lacking more accurate data and noting that Rose et al.'s estimate is for business interruption only, this study uses \$300 as the total direct and indirect cost of loss of electric service per day.

---

<sup>35</sup> Per <https://www.census.gov/quickfacts/CA>.

<sup>36</sup> Per <https://www.census.gov/quickfacts/CA>.

<sup>37</sup> Per <https://www.census.gov/quickfacts/CA>.

<sup>38</sup> Per [http://www.dof.ca.gov/Forecasting/Economics/Indicators/Gross\\_State\\_Product/](http://www.dof.ca.gov/Forecasting/Economics/Indicators/Gross_State_Product/).

<sup>39</sup> Per <https://www.gsa.gov/travel/plan-book/per-diem-rates>.

### 6.4.3.3. Deaths, Injuries, and Instances of Post-Traumatic Stress Disorder (PTSD) Resulting from Loss of Electric Service (e.g., Due to a Traffic Accident)

Loss of electric service can result in deaths, injuries, and instances of PTSD, for example, due to added traffic accidents in the absence of working traffic signals. While a number of papers in the literature qualitatively discuss this aspect (Beatty et al. 2006, Henneaux et al. 2011, Lin et al. 2011, Matthewman and Byrd 2014), only Anderson and Bell (2012) provides quantitative data, finding about 90 excess deaths occurred in New York City due to the 2003 Northeast Blackout, which had an average duration of about two days. This equates to 0.000005625 deaths per capita per day, which is used in this study. The value of a statistical life, or cost due to a fatality is \$9.4 million, so that the economic cost due to fatalities caused by loss of electrical service is \$53 per capita per day.

Regarding injuries, the Report includes an estimate of the number of earthquake-induced deaths and nonfatal injuries in buildings, as a result of all causes: structural damage, nonstructural damage, and other causes such as falls and occupant behavior. The analysis found that building occupants face a risk of nonfatal injury on the order of 1,000 times as high as the risk of fatal injuries. The ratio counts injuries requiring treatment by medical professionals or paraprofessionals (emergency medical services), not injuries for which people would not typically seek aid. These include four degrees of nonfatal injury severity, from generally most to least severe and from generally least to most common: hospitalized trauma cases, hospitalized non-trauma cases, people treated and released in an emergency department, and those treated outside of a hospital.

As a check of this purely analytically derived ratio of 1,000 nonfatal injuries per death, researchers can compare it with the ratio of nonfatal injuries to fatal injuries in the 1994 Northridge Earthquake. As reported by several studies and compiled in Porter et al. (2006) for each fatal injury, at least 750 people experienced nonfatal injuries. The phrase “at least” refers to the fact that the Northridge researchers counted households rather than individual people for the last two categories of nonfatal injury. Since more than one person could have been injured in households reporting at least one injury, the ratio of people injured to people killed in the 1994 Northridge Earthquake could have been higher than 750. However, the 1994 Northridge Earthquake injured no more than about 1% of the population to the degree that they required medical treatment, so the conditional probability that two people in a household given that one was injured seems low, probably between 1% and 10%. (The conditional probability, asserted here to be between 1% and 10%, is probably higher than the marginal probability—the 1% figure just mentioned—because of correlation resulting from common causes.) Therefore, assume 1.05 persons injured per household with at least one nonfatal injury, suggesting that the Northridge Earthquake injured on the order of 800 people per fatality. Take an average of the two figures—analytical and empirical—as the best estimate for normal, building-related injuries, and use a ratio of 900 nonfatal injuries per fatal injury.

Naturally, this raises questions about the applicability of is the 900 to 1 figure in the case of disrupted electric power. Is injury epidemiology from loss of electric power similar to injury epidemiology caused by other earthquake-related causes? The answer matters to whether the ratio of 900 to 1, which reflects building damage, is actually applicable to electric power. Anderson and Bell (2012) found that most excess

## NATURAL HAZARD MITIGATION SAVES:

deaths during an August 2003 power outage in New York had disease-related causes, as opposed to falls in the dark and other trauma injuries that seem to dominate earthquake-related injuries.

Medicare data show 180 hospital discharges including deaths per 1,000 Medicare enrollees nationwide in 2014 (Dartmouth Institute 2018), and 45 deaths per year per 1,000 Medicare enrollees (Krumholz et al. 2015), suggesting 3 nonfatal injuries per fatal injury for disease-related hospitalization.

Determining which ratio to use, 900 to 1 or 3 to 1, impacts the overall BCR. The former is mostly from trauma: impact by structural and nonstructural objects, falls that seem associated with ground and building movement, and unsafe behavior caused by panic. The latter is purely related to disease, but would exclude some uniquely earthquake-related non-trauma injuries, such as dehydration from prolonged entrapment in elevators. A best estimate might lie somewhere between the two figures. Let us use a figure closer to the 3 to 1 ratio than the 900 to 1 ratio, both to err on the low side and because the causes of the 3 to 1 ratio seem more similar to the ones at issue here. The project team therefore used the geometric mean of the two figures, 52 to 1, for the present analysis. Using a value of a statistical injury, or cost due to an injury of \$0.55 million MMC is  $52 \times \$53 \times (0.55/9.4) = \$161$  per capita per day.

Lacking data, at present no costs are ascribed to PTSD due to loss of electric service.

Therefore, the total cost per capita per day due to the loss of electric service is the sum of the economic costs plus mortality plus morbidity, or  $\$300 + \$53 + \$161 = \$514$  per capita per day.

The total costs of loss of electric service is this value plus direct damage to electric substations. The possibility of damage to generation equipment due to a blackout exists, but is not accounted for in this analysis.

### 6.4.4. Benefit-Cost Analysis

The benefit of a resilient grid is calculated as the present value of the reduction in losses, accounting for the frequency of shaking that causes those losses. The project team examined four case studies, for substations located in the Los Angeles, San Francisco, Portland and Seattle regions. As discussed, the cost of retrofit of a substation is \$5 million.

Annual frequency of PGA is inversely correlated and varies by location in the United States, as illustrated in Figure 6-62. Given the hazard and the expected damage under unanchored and anchored conditions, researchers can numerically integrate to determine the benefit per annum,  $B_{pa}$ , attributable to a retrofitted substation:

$$B_{pa} = \sum_{PGA=0}^{1.5} B(PGA)f(PGA)\Delta PGA$$

Equation 6-17

where  $B(PGA)$  is the benefit as a function of  $PGA$ ,  $f(PGA)$  is the annual frequency of  $PGA$ , and  $\Delta PGA$  is the  $PGA$  interval employed in the numerical summation.

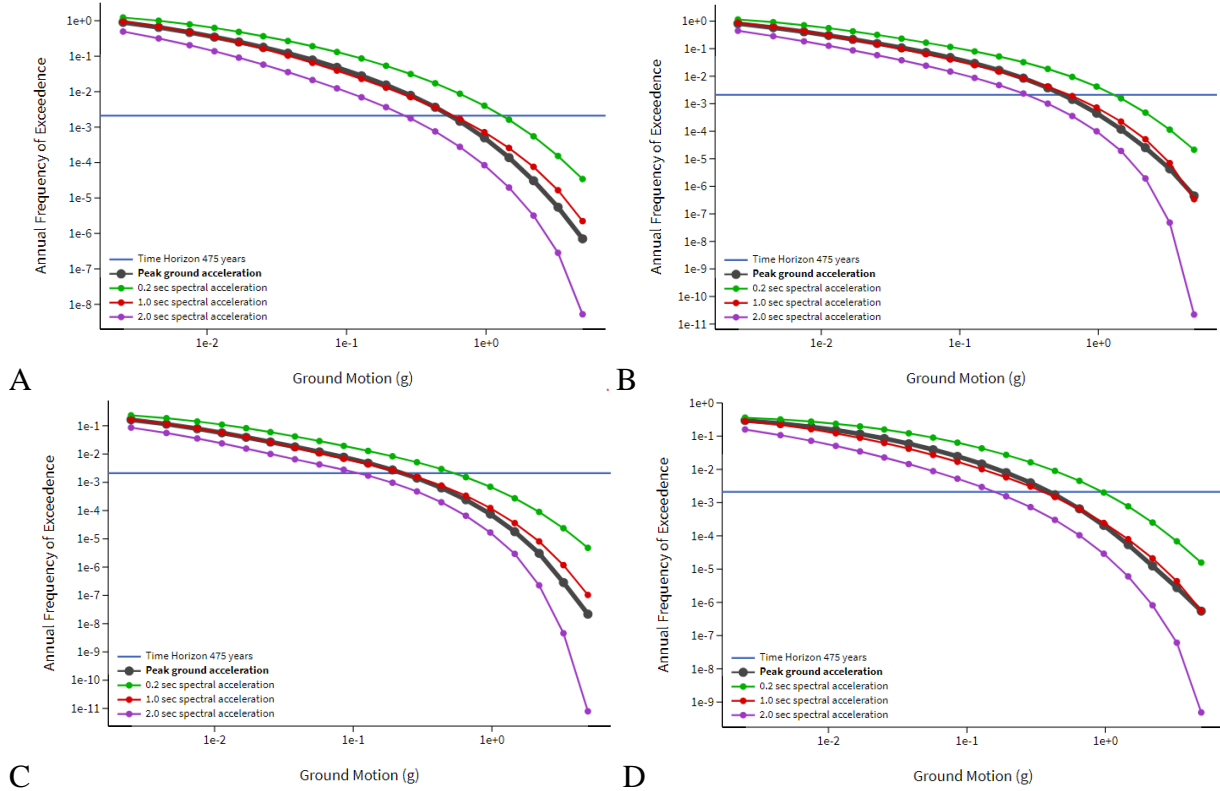

Note: assuming average shearwave velocity in the upper 30 meters of soil to be  $V_{s30} = 360$  m/sec/.

Source: <https://earthquake.usgs.gov/hazards/interactive/>

Figure 6-62: Annual frequency of PGA for (A) Los Angeles, (B) San Francisco, (C) Portland, and (D) Seattle.

The present value of all future benefits  $PV(B)$  is then:

$$PV(B) = \int_0^T B_{pa} e^{-It} dt$$

Equation 6-18

where  $I$  is the cost-of-borrowing discount rate per annum (2.2%), and  $T$ , the time horizon of interest, was taken as 100 years.

## NATURAL HAZARD MITIGATION SAVES:

Using these values and integrating benefits and annual frequency of occurrence of *PGA*, the present value of all future benefits for the several West Coast cities is determined. Dividing the present value of all future benefits by the retrofit cost of a substation determines the benefit-cost ratio, *BCR*:

$$BCR = PV(B) / \text{replacement cost}$$

### Equation 6-19

This has been done for the four West Coast cities using a cost-of-borrowing discount rate of 2.2%.

For San Francisco, the present value of all future losses given an unanchored substation is found to be \$167 million. If the substation is seismically anchored for a design *PGA* of 0.47g (the default value in Hazus), this value reduces to \$129 million, or a reduction of \$38.3 million, which has been achieved at a retrofit cost of \$5 million – in other words, a *BCR* of 7.7. Comparable estimates are shown in Table 6-31.

**Table 6-31:** Benefits and costs of seismically retrofitting an existing electric substation in four West Coast cities.

City	Present value of future losses, \$ millions			BCR
	Unanchored	Retrofit to 0.47 g	Benefit	
San Francisco	\$168	\$129	\$38	8
Los Angeles	\$168	\$128	\$40	8
Seattle	\$126	\$95	\$31	6
Portland Oregon	\$40	\$30	\$10	2

An interesting point: it may be that even greater retrofit is justifiable. For example, given that the peak ground acceleration of 0.47g in San Francisco has about a 10% probability of being exceeded in a 50-year period, would it be cost-beneficial to anchor the substation equipment for a higher acceleration? For an anchorage design value of 1g, which has a negligible added cost, the present value of all future losses for an anchored substation in San Francisco is \$19 million, or a reduction in losses of \$148 million – in other words, a *BCR* of 29.6. This clearly demonstrates the cost effectiveness of mitigating critical infrastructure.

## 6.5. BENEFIT-COST ANALYSIS OF HIGHWAY BRIDGE MITIGATION FOR EARTHQUAKE

### 6.5.1. Background

Between the early 1970s and the early 1990s, a series of earthquakes resulted in freeway bridge collapses in urban areas. Notably, 43 people died as a result of a bridge failure following the 1989 Loma Prieta Earthquake in San Francisco. Caltrans identified bridges throughout the state that needed to be retrofitted to meet seismic safety standards (known as a Phase 1). Following the 1994 Northridge Earthquake, additional bridges were identified for a Phase 2. The Phase 1 and Phase 2 Seismic Retrofit Program

## NATURAL HAZARD MITIGATION SAVES:

involved strengthening the columns of existing bridges by encircling certain columns with a steel casing or, in a few instances, an advanced woven fiber casing. In addition to the column casing, some bridge footings were made bigger and given more support by placing additional pilings in the ground, or by using steel tie-down rods to better anchor the footings to the ground.

Quantifying the benefits of retrofitting bridges requires consideration of secondary impacts, which in many cases are far greater than the direct impacts. The delays from traffic disruption during reconstruction requires an assessment of traffic demand and freeway capacity, tools typically used to assess road construction and maintenance rather than loss estimation. The Reference Engineering Data Automated Retrieval System (REDARS) is a software program developed to quantify the primary and secondary impacts of earthquake damage to the transportation network with the specific purpose of evaluating state DOT bridge retrofit programs. REDARS has been peer reviewed and has been available as a framework for analysis for over 15 years. The software is designed to provide end users with a method to evaluate strategies to reduce post-event congestion by mitigating, repairing and reopening damaged highways.

### 6.5.2. REDARS Technical Specifications

Figure 6-63 illustrates the REDARS methodology. Seismicity is provided through a library of earthquake scenarios that can be run probabilistically. For each event, REDARS calculates probable bridge damage, the repair cost of direct damages, and estimates reconstruction time. REDARS includes a transportation network analysis that incorporates surveyed origin-destination data from local metropolitan planning organizations. Traffic disruption is quantified at various time frames following an event: 7 days, 60 days, 150 days, and 221 days. The value of traffic disruption is assessed by evaluating the additional duration that passengers and commercial freight drivers spend traveling. Given road closures, before-event transportation throughput and travel times are compared with after-event transportation throughput and travel times to quantify disruption.

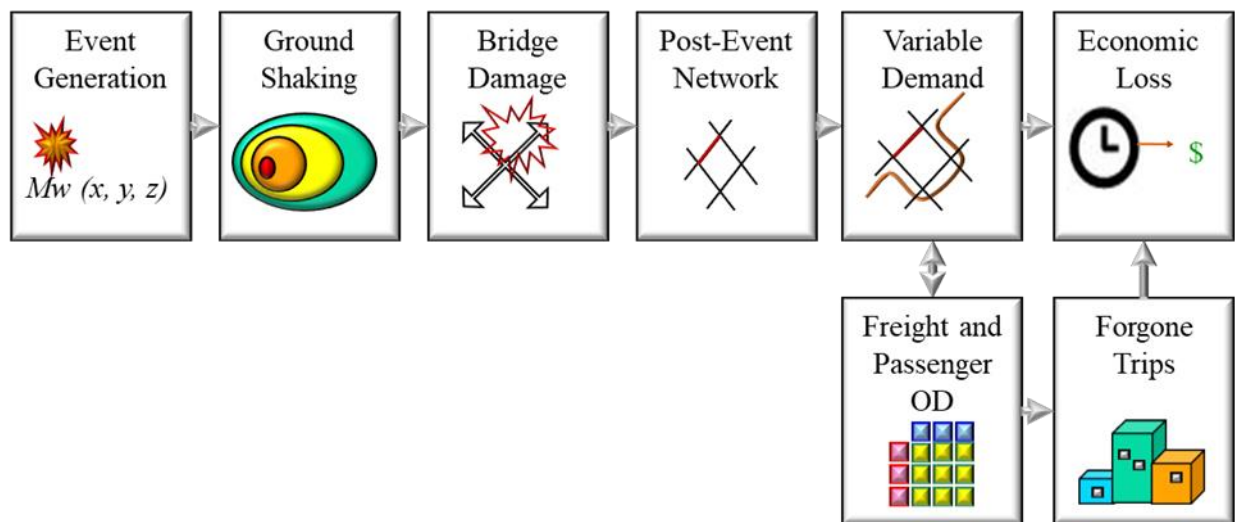

Figure 6-63: REDARS methodology flowchart.

## NATURAL HAZARD MITIGATION SAVES:

REDARS includes a library of equiprobable earthquake events (Taylor et al., 2001; Werner et al., 2006). It estimates ground motion at bridge and tunnel locations using Silva's (2002) ground motion prediction equation (GMPE) for central U. S. earthquakes, and Abrahamson and Silva (1997) for western states. Soil classification is based on NEHRP site classifications. Damage to highway system components (bridges, pavements, approach fills, tunnels, and embankments) affects the extent of the repairs that are required and the duration of downtime. Bridge damage due to ground shaking is estimated from a version of the Hazus MH damage functions (Federal Emergency Management Agency 2008; Dutta and Mander, 1998; Mander and Basoz, 1999) adjusted to improve comparisons between its bridge-damage predictions and observed damage from the Northridge Earthquake (Appendix K, Werner et al., 2006). The benefits of CalTrans Phase 1 and 2 retrofits were captured by incorporating damage functions from Shinozuka (2004) that were commissioned by Caltrans expressly for this purpose.

### 6.5.3. Benefit-Cost Analyses

REDARS requires an evaluation of a study region, and given system limitations, networks that are over 1,000 segments tend to fail. The project team selected a study region roughly corresponding to the Los Angeles metropolitan area. The team obtained a Caltrans bridge database from Caltrans identifying bridge retrofits throughout the region. These were loaded onto the Highway Performance Monitoring System (HPMS)/National Highway Planning Network (NHPN), which provides the geospatial component of the NHPN<sup>40</sup>. The NHPN provided the locations of 597 retrofitted bridges in the study area. Caltrans identified that a total of 656 bridges have been retrofitted in Southern California, for a total cost of \$485,000. These numbers were used to scale an estimated cost of retrofit to \$441,000.

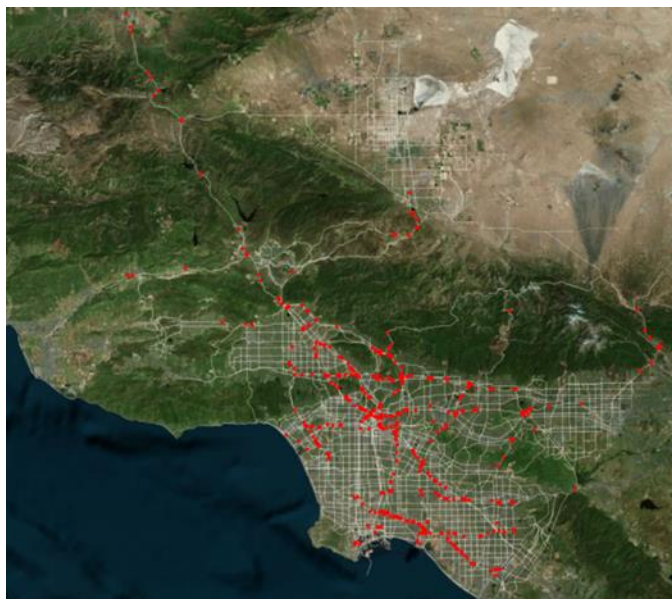

Figure 6-64: Los Angeles study region.

<sup>40</sup> See <https://catalog.data.gov/dataset/highway-performance-monitoring-system-hpms-national>.



## NATURAL HAZARD MITIGATION SAVES:

The project team incorporated casualty rates by examining fatalities due to bridge collapse in major California earthquakes since 1970 (see Table 6-32). A total of 47 fatalities were sustained from 14 bridge collapses in 4 events, or a fatality rate of 3.35 deaths per bridge collapse. Although Loma Prieta may appear as a statistical outlier given the number of deaths per bridge collapse, it is worth noting that the Northridge Earthquake occurred at 4:30 a.m. and the San Fernando Earthquake occurred at 6:00 a.m., so given a larger sample of events, the number of fatalities per bridge collapse could be substantially higher. Each fatality avoided is valued at \$9,500,000. A lifespan of 70 years is assumed for a retrofitted bridge, and future benefits from avoided traffic delays are discounted using a discount rate of 2.2%. Passenger delays are valued at \$21.38 per hour, taken from *California Transportation by the Numbers* (TRIP 2016), and freight is valued at \$71.05, a default value within REDARS based on traffic-congestion statistics from the Rand Corporation (Werner et al., 2006).

**Table 6-32:** Fatalities due to bridge collapse between 1970 and 2018.

	Collapsed	Deaths
San Fernando	5	3
Northridge	6	1
Whittier Narrows	-	-
Loma Prieta	3	43
Total	14	47

### 6.5.4. BCR Results

Based on a 3,000-year walkthrough of potential earthquakes effecting the transportation network, with and without bridge retrofits, there is a benefit of \$22 million avoided annually attributed to reduced reconstruction and traffic delays, with a \$166 baseline EAL in the case of no retrofitting, and \$144 million EAL considering the Caltrans bridge retrofits. Accrued over 70 years at a discount rate of 2.2%, this equates to a benefit of \$795 million. The annual probability of collapse is estimated at 0.044% before retrofit, and 0.0028% after retrofit, equating to an annual benefit of \$548 million. Total benefit is estimated \$1,344 million. Compared to the initial mitigation expenditure of \$441 million, the BCR equates to 3.0.

## 7. References

AdvisoryHQ (2017). *2017 Guide: Finding the Best Commercial Mortgage Rates & Real Estate Loan Rates*. <https://www.advisoryhq.com/articles/commercial-real-estate-loan-rates/>. [accessed 6 December 2017]

Ahern, M., Kovats, R.S., Wilkinson, P., Few, R., and Matthies, F. (2005). Global health impacts of floods: epidemiologic evidence. *Epidemiologic reviews*, 27(1), 36-46.

ALA (2001). *Seismic Fragility Formulations For Water Systems, Part 1 - Guidelines*. Pp. 104: American Lifelines Alliance.

Alameda, California (2009). *City of Alameda Ordinance Number 2989, Amending the Alameda Municipal Code by Adding Article XX (Earthquake Hazard Reduction in Existing Soft-Story Residential Buildings) to Chapter XIII (Building and Housing) and Amending Subsection 30-7.12 (Reduction in Parking Requirements for Existing Facilities) of Section 30-7 (Off-Street Parking and Loading Space Regulations) of Chapter XXX (Development Regulations) by Adding Subsection 30-7.12(C) to Allow for Reduction in Parking Requirements for Seismic Retrofit*. Alameda City Clerk, 10 p. [https://alamedaca.gov/sites/default/files/department-files/2012-10-15/2009\\_soft\\_story\\_ordinance.pdf](https://alamedaca.gov/sites/default/files/department-files/2012-10-15/2009_soft_story_ordinance.pdf) [retrieved November 15, 2018]

Allianz Global Corporate and Specialty (2015). Business Interruption Claims on the Rise. *Insurance Journal*. <http://www.insurancejournal.com/news/international/2015/12/10/391437.htm>. [accessed 31 July 2017].

American Wood Council (2015). *Wood Frame Construction Manual (WFCM) for One- and Two-Family Dwellings*. Wood Design Standards Committee, 314 p. <http://www.awc.org/pdf/codes-standards/publications/wfcm/AWC-WFCM2015-ViewOnly-1510.pdf> [accessed 14 November 2016]

Anagnos, T., and D. Ostrom (2000). Electrical Substation Equipment Damage Database For Updating Fragility Estimates. *Proc. 12th World Conference on Earthquake Engineering*, Auckland, New Zealand Paper No. 2262.

Anderson C., Santos J.R., and Haines Y.Y. (2007). A risk-based input-output methodology for measuring the effects of the August 2003 northeast blackout. *Economic Systems Research*, 19, 183-204.

Anderson, G. B., and M. L. Bell. (2012). Lights out: impact of the August 2003 power outage on mortality in New York, NY. *Epidemiology* (Cambridge, Mass.) 23:189.

Angie's List (2013). *How Much Does It Cost to Build a Handicap Accessible Ramp?* <http://answers.angieslist.com/how-cost-build-handicap-accessible-ramp-q48414.aspx>. [accessed 6 December 2017]

Applied Research Associates (2008). *Florida Residential Wind Loss Mitigation Study*. <https://www.flor.com/siteDocuments/ARALossMitigationStudy.pdf>.

## NATURAL HAZARD MITIGATION SAVES:

Applied Technology Council (1991). *Seismic Vulnerability and Impact of Disruption of Lifelines in the Conterminous United States, FEMA 224*. Federal Emergency Management Agency, Washington, DC. <http://www.fema.gov/plan/prevent/earthquake/pdf/fema-224.pdf> [viewed 6 June 2006], <http://www.fema.gov/plan/prevent/earthquake/professionals.shtm> [accessed 6 June 2006]

Applied Technology Council, Scawthorn, C., Khater, M., Rojahn, C., & Cluff, L. S. (1991). *Seismic Vulnerability and Impact of Disruption of Lifelines in the Conterminous United States*. Applied Technology Council.

Applied Technology Council (2000). *ATC-38: Database on the Performance of Structures near Strong-Motion Recordings: 1994 Northridge, California, Earthquake*, Redwood City, CA, 260 pp. with CD-ROM

Applied Technology Council (2005). *ATC-20-1: Field Manual: Postearthquake Safety Evaluation of Buildings*, 2nd Edition, Redwood City, CA, 144 pp.

Applied Technology Council (2009a). *ATC-52-3 Here Today—Here Tomorrow: The Road to Earthquake Resilience in San Francisco Earthquake Safety for Soft-Story Buildings*. Redwood City, California, 60 p.

Applied Technology Council (2009b). *Quantification of Building Seismic Performance Factors. FEMA P-695*, Federal Emergency Management Agency, Washington, DC, 421 pp.

Applied Technology Council (2010). *Here Today—Here Tomorrow: The Road To Earthquake Resilience In San Francisco, Potential Earthquake Impacts*. ATC-52-1 San Francisco: Prepared for the Department of Building Inspection, City and County of San Francisco, under the Community Action Plan for Seismic Safety (CAPSS) Project by the Applied Technology Council.

Applied Technology Council (2012). *Seismic Performance Assessment of Buildings Volume 1 – Methodology FEMA P-58-1*. Federal Emergency Management Agency, Washington, DC, [https://www.fema.gov/media-library-data/1396495019848-0c9252aac91dd1854dc378feb9e69216/FEMAP-58\\_Volume1\\_508.pdf](https://www.fema.gov/media-library-data/1396495019848-0c9252aac91dd1854dc378feb9e69216/FEMAP-58_Volume1_508.pdf) [accessed 08 Dec 2016]

Applied Technology Council (ND). *ATC Hazards by Location*. <https://hazards.atcouncil.org/> [accessed Oct 19, 2018]

ASCE (1999). *Guide to Improved Earthquake Performance of Electric Power Systems*. Prepared by Electric Power and Communications Committee, Anshel J. Schiff (ed.), Technical Council on Lifeline Earthquake Engineering, American Society of Civil Engineers, Reston.

(ASCE) American Society of Civil Engineers (2013). *Seismic Rehabilitation of Existing Buildings. ASCE/SEI Standard 41-13*.

(ASCE) American Society of Civil Engineers (2014). *Flood Resistant Design and Construction, ASCE/SEI Standard 24-14*.

## NATURAL HAZARD MITIGATION SAVES:

(ASCE) American Society of Civil Engineers (2018). ASCE 7 Hazard Look-up Tool, <https://asce7hazardtool.online/>.

(ASCE) American Society of Civil Engineers. Unpublished. *Preliminary Minimum Design Loads for Buildings and Other Structures. ASCE/SEI Standard 7-16*. Provided by Peter Vickery, ARA, Raleigh N.C.

(ASCE/SEI) American Society of Civil Engineers Structural Engineering Institute (2010). *Minimum Design Loads for Buildings and Other Structures, ASCE/SEI 7-10*, Reston VA, 608 pp

(ASCE/SEI) American Society of Civil Engineers Structural Engineering Institute (2017). *Minimum Design Loads for Buildings and Other Structures. ASCE/SEI Standard 7-16*.

(ASFPM) Association of State Floodplain Managers. (2013). *NAI How-to Guide for Mitigation*, Madison, WI, 76 p. Retrieved from <http://www.floods.org/ace-images/ASFPM-MitigationFinalJuly28.pdf>. [accessed 30 Jan 2017].

Association for the Advancement of Automotive Medicine (2001). *Abbreviated Injury Scale (AIS) 1990 - Update 98*, Barrington IL, 68 pp.

Awondo, S., Hollans, H., Powell, L., and Wade, C. (n.d.). *Estimating the Effect of FORTIFIED Home™ Construction on Home Resale Value*. Alabama Center for Information and Insurance Research (ACIIR), Culverhouse College of Commerce, Tuscaloosa, AL 35487. 6 pp.

Beatty, M. E., S. Phelps, and C. Rohner (2006). Blackout of 2003: Public Health Effects and Emergency Response. *Public Health Reports* 12:36-44.

Beavers, J.E. (2002). A review of seismic hazard description in US design codes and procedures. *Progress in Structural Engineering and Materials* 4:46-63

Benuska, L. (1990). Loma Prieta Earthquake reconnaissance report. *Earthquake Spectra*, Supplement to Volume 6, 127-149.

Berko, J., Ingram, D.D., Saha, S., and Parker, J.D. (2014). Deaths attributed to heat, cold, and other weather events in the United States, 2006–2010. *National Health Statistics Reports* 76. Hyattsville, MD: National Center for Health Statistics, <https://www.cdc.gov/nchs/data/nhsr/nhsr076.pdf> [accessed 29 Aug 2017].

Berkeley California City Clerk (2014). *Berkeley Municipal Code Title 19 Buildings and Construction*. Berkeley, California, p. 56-62, <https://www.codepublishing.com/CA/Berkeley/html/pdfs/Berkeley19.pdf> [retrieved November 14, 2018]

Berlin, G.L. (1980). *Earthquakes and the Urban Environment, Volume 2*. CRC Press, Boca Raton, FL, 186 p.

## NATURAL HAZARD MITIGATION SAVES:

Birchard, K., Storesund, R., and Buck, S. (2016). *Flood Control 2.0: Economic Analysis, Guidebook for Economic Analysis of Flood Control Alternatives*, The Integrative Economics, LLC.

Bloom, D.E., Caero, E.T., Jané-Llopis, E., Abrahams-Gessel, S., Bloom, L.R., Fathima, S., Feigl, A.B., Gaziano, T., Mowa, M., Pandya, A., Prettner, K., Rosenberg, L., Seligman, B., Stein, A.Z., and Weinstein, C. (2011). *The Global Economic Burden of Noncommunicable Diseases*. Geneva: World Economic Forum. 46 p.

Bolen, W. (2001). *Sand and Gravel, Construction*. U.S. Geological Survey. 2001.  
<https://minerals.usgs.gov/minerals/pubs/commodity/sand & gravel construction/sandmyb01.pdf>.

Börjesson, P., and Gustavsson, L. (2000). Greenhouse gas balances in building construction: wood versus concrete from life-cycle and forest land-use perspectives. *Energy Policy* 28 (9): 575-588.

Building Officials and Code Administrators International, Inc. (1950 et seq.). *The BOCA National Building Code*. Country Club Hills, IL: Building Officials and Code Administrators International, Inc.

Building Seismic Safety Council, 1985. *NEHRP Recommended Provisions for the Development of Seismic Regulations for New Buildings*, prepared for the Federal Emergency Management Agency. Washington, DC.

Burby, R.J. (2006). Hurricane Katrina and the paradoxes of government disaster policy: Bringing about wise governmental decisions for hazardous areas. *The Annals of the American Academy of Political and Social Science*, 604 (1), 171-191.

Burby, R.J., May, P.J., Malizia, E.E., and Levine, J. (2000). Building code enforcement burdens and central city decline. *Journal of the American Planning Association*, 66(2), 143-161.

(BEA) Bureau of Economic Analysis (2016), *Input-Output Accounts Data*.  
[https://bea.gov/industry/io\\_annual.htm](https://bea.gov/industry/io_annual.htm). [accessed 19 December 2017]

Bureau of Labor Statistics (2017a). *Economy at a Glance*. <https://www.bls.gov/eag/home.htm>. [accessed December 6, 2017]

Bureau of Labor Statistics (2017b). *Employment, Hours, and Earnings from the Current Employment Statistics survey (National)*. [https://data.bls.gov/timeseries/CES2000000001?data\\_tool=XGtable](https://data.bls.gov/timeseries/CES2000000001?data_tool=XGtable). [accessed December 6, 2017]

Bowman, D., Daniels, L., Johnston, F., Williamson, G., Jolly, W., Magzamen, S., Rappold, A., Brauer, M., and Henderson, S. (2018). Can air quality management drive sustainable fuels management at the temperate wildland–urban interface? *Fire* 1(2):27

Byram, G. M. (1959). Combustion of forest fuels. Pp. 61-89. in *Forest Fire: Control and Use*, 2nd edition. New York: McGraw-Hill.

## NATURAL HAZARD MITIGATION SAVES:

- California (ND). *California Code, Health and Safety Code - HSC § 19211*. Findlaw. <https://codes.findlaw.com/ca/health-and-safety-code/hsc-sect-19211.html> [retrieved February 19, 2019]
- California Department of Housing and Community Development (1991). *Evaluation of Manufactured Housing Support System Performance in the Loma Prieta Earthquake*. Sacramento, CA, 14 p.
- California Department of Housing and Community Development (1992). *The Effectiveness of Manufactured Home Support Systems During Earthquakes*. Sacramento, CA, 28 p.
- California Legislature (1994). An Act to Amend Section 18613.1 of, and to Add Section 18613.4 to, the Health and Safety Code, Relating to Housing, and Declaring the Urgency Thereof, to Take Effect Immediately. [http://www.leginfo.ca.gov/pub/93-94/bill/sen/sb\\_0701-0750/sb\\_750\\_bill\\_940721\\_chaptered](http://www.leginfo.ca.gov/pub/93-94/bill/sen/sb_0701-0750/sb_750_bill_940721_chaptered) [retrieved December 13, 2018]
- California Seismic Safety Commission (2005). *Homeowner's Guide to Earthquake Safety*, SSC No, 05-01, Sacramento, California 49 p. [https://ssc.ca.gov/forms\\_pubs/cssc\\_2005\\_hogreduced.pdf](https://ssc.ca.gov/forms_pubs/cssc_2005_hogreduced.pdf) [retrieved December 15, 2018]
- Caltech Design and Construction (2014). *Appendix VII A Note on Earthquake Design of Caltech Buildings*. Pasadena, CA: California Institute of Technology, [https://www.dandc.caltech.edu/documents/113-caltech\\_appendix\\_vii.pdf](https://www.dandc.caltech.edu/documents/113-caltech_appendix_vii.pdf).
- Caton, S. E., Hakes, R. S., Gorham, D. J., Zhou, A., and Gollner, M. J. (2017). Review of pathways for building fire spread in the wildland urban interface part I: exposure conditions. *Fire Technology*, 53 (2), 429-473.
- Census Reporter (2019-KP1) *Census Reporter*. <https://censusreporter.org/profiles/06000US0603792785-san-fernando-valley-ccd-los-angeles-county-ca/> [retrieved February 8, 2019]
- Chen, K., and McAneney, J. (2004). Quantifying bushfire penetration into urban areas in Australia. *Geophysical Research Letters*, 31:L12212.
- Cho, I.H., and Porter, K. (2016). Modeling building classes using moment matching. *Earthquake Spectra* 32 (1): 285-301.
- Chopra, A., and Goel, R. (2000). Building period formulas for estimating seismic displacements. *Earthquake Spectra* 16 (2), 533-536.
- Christopoulos, C., Filiatrault, A., Uang, C.M., and Folz, B. (2002). Posttensioned energy dissipating connections for moment-resisting steel frames. *Journal of Structural Engineering*, 128(9), 1111-1120.
- City of Los Angeles Department of Building and Safety (2019). *Soft-Story Retrofit Program*. <http://www.ladbs.org/services/core-services/plan-check-permit/plan-check-permit-special-assistance/mandatory-retrofit-programs/soft-story-retrofit-program> [retrieved March 25, 2019]

## NATURAL HAZARD MITIGATION SAVES:

City of Moore (2014a). "City Adopts New Building Codes, First in the Nation."  
<https://www.cityofmoore.com/node/2111> [accessed November 8, 2017].

City of Moore (2014b). *City of Moore Municipal Code*.  
[https://library.municode.com/ok/moore/codes/code\\_of\\_ordinances?nodeId=COOR\\_PT5BURECO\\_CH2BUCORE\\_ARTABUCO\\_S5-202AMBUCO](https://library.municode.com/ok/moore/codes/code_of_ordinances?nodeId=COOR_PT5BURECO_CH2BUCORE_ARTABUCO_S5-202AMBUCO) [accessed November 8, 2017].

Clinton, W.J. (1994). Executive Order #12893 Principles for Federal Infrastructure Investments, Washington, DC.

Cohen, J.D. (1995). Structure ignition assessment model (SIAM). Weise, D.R. and Martin, R.E., technical coordinators. *Proceedings of the Biswell symposium: Fire Issues and Solutions in Urban Interface and Wildland Ecosystems*: 15-17.

Congressional Budget Office (2017). *The National Flood Insurance Program: Financial Soundness and Affordability*. Washington, DC, 44 p.

Constantinou, M.C., Soong, T.T., and Dargush, G.F. (1998). *Passive Energy Dissipation Systems for Structural Design and Retrofit*. Buffalo, New York: Multidisciplinary Center for Earthquake Engineering Research.

Cook, J., Oreskes, N., Doran, P. T., Anderegg, W. R., Verheggen, B., Maibach, E. W. and Nuccitelli, D. (2016). Consensus on consensus: a synthesis of consensus estimates on human-caused global warming. *Environmental Research Letters*, 11(4), 048002.

Cornell University (2008) *GIRAFFE User's Manual, Version 4.2*. Ithaca: Cornell University.

COSMOS Strong Motion Center (2018). *CESMD Information for Strong-Motion Station AK:Anchorage;USGS ESC USGS - NSMP Station 8047*. <https://www.strongmotioncenter.org/cgi-bin/CESMD/stationhtml.pl?stationID=NP8047&network=NSMP> [accessed December 9, 2018]

Darestani, Y.M., Shafieezadeh, A., and DesRoches, R. (2017). *Effects of Adjacent Spans and Correlated Failure Events on System-Level Hurricane Reliability of Power Distribution Lines*, IEEE (in publication).

Dartmouth Institute for Health Policy and Clinical Practice (2018). *The Dartmouth Atlas of Health Care*, Dartmouth College, Lebanon NH, <http://www.dartmouthatlas.org/>

Davis, C.A. (2017). Developing a seismic resilient pipe network using performance-based seismic design procedures. Pp. 406-418 in *The 10th JWWA/WRF/CTWWA Water System Seismic Conference*, edited by Nan-Tzer Hu and Shyh-Jiann Hwang. Tainan, Taiwan: National Center For Research on Earthquake Engineering.

DHS (2003). *Multi-Hazard Loss Estimation Methodology, Earthquake Model, Hazus-Mh Mr3 Technical Manual*. 699 pp. Washington, DC.: Developed by: Department of Homeland Security, Emergency

## NATURAL HAZARD MITIGATION SAVES:

Preparedness and Response Directorate, FEMA Mitigation Division Washington, D.C. Under a contract with: National Institute of Building Sciences.

Dietzenbacher, E., and Lahr, M. L. (2004). *Wassily Leontief and input-output economics*. Cambridge, UK: Cambridge University Press.

Dillon, G.K., Menakis, J., and Fay, F. (2015). Wildland fire potential: a tool for assessing wildfire risk and fuels management needs. *USDA Forest Service Proceedings RMRS-P-73*: 60-76

DJC Oregon (2010). "Gresham Updating Fire Stations." <http://djcoregon.com/news/2010/08/26/gresham-upgrading-fire-stations/> [accessed November 12, 2017].

DOE (2012). *Large power transformers and the US electric grid*. Page 55 in Department of Energy, editor. Office of Electricity Delivery and Energy Reliability, Washington.

DOE (2017). *Quadrennial Energy Review Second Installment - Transforming The Nation's Electricity System*. Page 512. Office of Electricity Delivery and Energy Reliability, Department of Energy, Washington.

D'Oro, R. and Joling, D. (2018). Powerful quakes buckle Alaska roads, trigger tsunami warning. *Associated Press* Nov 30, 2018 Updated Dec 14, 2018. <https://chicago.suntimes.com/news/earthquake-alaska-anchorage/> [retrieved December 17, 2018]

Dotinga, R. (2010). San Diego's not-so-shaky quake history. *Voice of San Diego*. <https://www.voiceofsandiego.org/topics/news/san-diegos-not-so-shaky-quake-history/> [retrieved March 25, 2019]

DRM International (2003). *A Review of Manufactured Housing Installation Standards and Instructions*. Washington, DC, 57 p. [https://www.huduser.gov/portal/Publications/PDF/Report\\_DRM.pdf](https://www.huduser.gov/portal/Publications/PDF/Report_DRM.pdf) (accessed June 10, 2019)

Drysdale, D. (1999). *An Introduction to Fire Dynamics*. Chichester, New York: Wiley.

Duddu, P. (2015). The 10 worst blackouts of the last 50 years. *Power Technology*. available at <https://www.power-technology.com/features/featurethe-10-worst-blackouts-in-the-last-50-years-4486990/>.

Dunn, S., Wilkinson, S., Alderson, D., Fowler, H., and Galasso, C. (2018). Fragility curves for assessing the resilience of electricity networks constructed from an extensive fault database. *Natural Hazards Review*, 19 (1).

Dutta, A. and Mander, J.B. (1998). Seismic fragility analysis of highway bridges. In *Proceedings of the INCEDE-MCEER Center-to-Center Project Workshop on Earthquake Engineering Frontiers in Transportation Systems*, pp. 22-23.



## NATURAL HAZARD MITIGATION SAVES:

Earthquake Country Alliance (2018). *Step 1: Secure Your Space*. <https://www.earthquakecountry.org/step1/> [retrieved December 15, 2018]

Eckstein, O. (1958). *Water Resource Development: The Economics of Project Evaluation*, Otto Eckstein. Cambridge: Harvard University Press.

Emanuel, K. A. (2013). Downscaling CMIP5 climate models shows increased tropical cyclone activity over the 21st century. *Proceedings of the National Academy of Sciences*, 110(30), 12219-12224.

Emporis Corporation (2007). *Emporis Research*. [www.emporis.com](http://www.emporis.com)

EQE International (1994). *The January 17, 1994 Northridge, CA Earthquake An EQE Summary Report*. March 1994. San Francisco, CA, [https://www.lafire.com/famous\\_fires/1994-0117\\_NorthridgeEarthquake/quake/00\\_EQE\\_contents.htm](https://www.lafire.com/famous_fires/1994-0117_NorthridgeEarthquake/quake/00_EQE_contents.htm) [accessed November 26, 2018]

EQE International and the Governor's Office of Emergency Services (1995). *The Northridge Earthquake of January 17, 1994: Report of Data Collection and Analysis, Part A: Damage and Inventory Data*, EQE International, Irvine, California, 322 p.

(FEMA) Federal Emergency Management Agency (1992). *Building Performance: Hurricane Andrew in Florida: Observations, Recommendations and Technical Guidance*. Federal Emergency Management Agency Federal Insurance Administration. 17 p.

(FEMA) Federal Emergency Management Agency (2003). *Flood Insurance Study: Horry County, South Carolina and Incorporated Areas*, Flood Insurance Study Number 45051CV000A.

(FEMA) Federal Emergency Management Agency (2003). *HAZUS-MH MR3 Technical Manual - Earthquake Module*. Federal Emergency Management Agency.

(FEMA) Federal Emergency Management Agency (2003). *Ice Storm of 2002: Four Rural Electric Cooperatives in Kansas*, EMW-2000-CO-0247 HMTAP TO 312.

(FEMA) Federal Emergency Management Agency (2003). *Multi-Hazard Loss Estimation Methodology, Earthquake Model, Hazus-Mh Mr4 Technical Manual*. Developed by: Department of Homeland Security, Federal Emergency Management Agency, Mitigation Division, Under a contract with: National Institute of Building Sciences, Washington, D.C.

(FEMA) Federal Emergency Management Agency (2005a). *Third Party Analysis of Manufactured Home Retrofit Tie Downs. Assessment & Analysis – State of Florida Residential Construction Mitigation Retrofit Program*. DR-1539 / 1545 / 1551 / 1565 – Orlando – LTRO

(FEMA) Federal Emergency Management Agency (2005b). *FEMA P-480 Floodplain Management Requirements*. Washington, DC, 583 p.

## NATURAL HAZARD MITIGATION SAVES:

(FEMA) Federal Emergency Management Agency (2006a). *Flood Insurance Study: A Report of Flood Hazards in Dare County, North Carolina and Incorporated Areas*, Flood Insurance Study Number 37055CV000A.

(FEMA) Federal Emergency Management Agency (2006b). *Flood Insurance Study: Santa Rosa County, Florida and Incorporated Areas*, Flood Insurance Study Number 12113CV000A.

(FEMA) Federal Emergency Management Agency (2006c). *Multi-hazard Loss Estimation Methodology - Flood Model: HAZUS-MH Technical Manual*.

(FEMA) Federal Emergency Management Agency (2006e). *Hurricane Katrina in the Gulf Coast, Mitigation Assessment Team Report, Building Performance Observations, Recommendations, and Technical Guidance*. FEMA 549. P. 4-49, 4-50, 4-54

(FEMA) Federal Emergency Management Agency (2007a). *Design Guide for Improving Hospital Safety in Earthquakes, Floods and High Winds: Providing Protection to People and Buildings*, FEMA 577.

(FEMA) Federal Emergency Management Agency (2007b). *Flood Insurance Study: Gulf County, Florida and Incorporated Areas*, Flood Insurance Study Number 12045CV000B.

(FEMA) Federal Emergency Management Agency (2007c). *Flood Insurance Study-Preliminary: James City County, Virginia and Incorporated Areas*, Flood Insurance Study Number 51095CV000A.

(FEMA) Federal Emergency Management Agency (2007d). *Design Guide for Improving Critical Facility Safety from Flooding and High Winds: Providing Protection to People and Buildings*, FEMA 543.

(FEMA) Federal Emergency Management Agency (2008). *Electrical Transmission and Distribution Mitigation: Loss Avoidance Study - Nebraska and Kansas*. FEMA-1674-DR-KS and FEMA-1675-DR-NE.

(FEMA) Federal Emergency Management Agency (2008a). *2008 Supplement to the 2006 Evaluation of the National Flood Insurance Program's Building Standards*. Washington, DC, 14 p. Retrieved from [https://www.fema.gov/media-library-data/20130726-1911-25045-9876/2008\\_freeboard\\_report.pdf](https://www.fema.gov/media-library-data/20130726-1911-25045-9876/2008_freeboard_report.pdf) [accessed 13 January 2017].

(FEMA) Federal Emergency Management Agency (2008b). *Flood Damage-Resistant Materials Requirements for Buildings Located in Special Flood Hazard Areas in accordance with the National Flood Insurance Program, FEMA Technical Bulletin 2*. Washington, DC, 20 p. Retrieved from <http://www.jacksonms.gov/DocumentCenter/View/440> [accessed January 25 2017].

(FEMA) Federal Emergency Management Agency (2008c). *Flood Insurance Study: Lee County, Florida and Incorporated Areas*, Flood Insurance Study Number 12071CV001A.

## NATURAL HAZARD MITIGATION SAVES:

(FEMA) Federal Emergency Management Agency (2008d). *Flood Insurance Study-Preliminary: Lafourche Parish, Louisiana and Incorporated Areas*, Flood Insurance Study Number 22057CV000A.

(FEMA) Federal Emergency Management Agency (2008e). NFIP Technical Bulletin 1, Openings in Foundation Walls and Walls of Enclosures. Washington, DC, 34 p.

(FEMA) Federal Emergency Management Agency (2008f). NFIP Technical Bulletin 2, Flood Damage-Resistant Materials Requirements. Washington, DC, 22 p.

(FEMA) Federal Emergency Management Agency (2009a). *Flood Insurance Study: Bay County, Florida and Incorporated Areas*, Flood Insurance Study Number 12005CV000B.

(FEMA) Federal Emergency Management Agency (2009b). *Flood Insurance Study: Pinellas County, Florida and Incorporated Areas*, Flood Insurance Study Number 12103CV000C.

(FEMA) Federal Emergency Management Agency (2009c). *Quantification of Building Seismic Performance Factors*, FEMA P-695.

(FEMA) Federal Emergency Management Agency (2009d). *Recommended Residential Construction for Coastal Areas: Building on Strong and Safe Foundations*, FEMA P-550.

(FEMA) Federal Emergency Management Agency (2009e). *FEMA P-765 Midwest Floods of 2008 in Iowa and Wisconsin*. Washington, DC, 258 p.

(FEMA) Federal Emergency Management Agency (2010a). *Design Guide for Improving School Safety in Earthquakes, Floods and High Winds*, FEMA P-424.

(FEMA) Federal Emergency Management Agency (2010b). *Wind Retrofit Guide for Residential Buildings*. FEMA P-804.

(FEMA) Federal Emergency Management Agency (2011a). *Coastal Construction Manual. Principles and Practices of Planning, Siting, Designing, Constructing, and Maintaining Residential Buildings in Coastal Areas* (Fourth Edition) FEMA P-55/Volume II.

(FEMA) Federal Emergency Management Agency (2011b). *Multi-hazard Loss Estimation Methodology Flood Model Hazus® -MH 2.1 Technical Manual*. Federal Emergency Management Agency, Washington, DC, 569 pp.

(FEMA) Federal Emergency Management Agency (2011 E74). *FEMA E-74 Reducing the Risks of Nonstructural Earthquake Damage – A Practical Guide*. Washington, DC, 755 p.

## NATURAL HAZARD MITIGATION SAVES:

(FEMA) Federal Emergency Management Agency (2012). *Multi-hazard Loss Estimation Methodology Earthquake Model Hazus®-MH 2.1 Technical Manual*. Federal Emergency Management Agency, Washington, DC, 718 pp.

(FEMA) Federal Emergency Management Agency (2012a). *Flood Insurance Study: Collier County, Florida*, Flood Insurance Study Number 12021CV000B.

(FEMA) Federal Emergency Management Agency (2012b). *Flood Insurance Study-Preliminary: Calhoun County, Texas and Incorporated Areas*, Flood Insurance Study Number 48057CV001A.

(FEMA) Federal Emergency Management Agency (2012c). *Flood Insurance Study-Preliminary: Jefferson County, Texas and Incorporated Areas*, Flood Insurance Study Number 48245CV000A.

(FEMA) Federal Emergency Management Agency (2012d). *FEMA P-58-1: Seismic Performance Assessment of Buildings. Volume 1—Methodology*. Washington, DC.

(FEMA) Federal Emergency Management Agency (2012e). *FEMA P-259 Engineering Principles and Practices for Retrofitting Flood-Prone Residential Structures (3<sup>rd</sup> Edition)*. Washington, DC, 510 p.

(FEMA) Federal Emergency Management Agency (2012 SSWF). *FEMA P-807 Seismic Evaluation and Retrofit of Multi-Unit Wood-Frame Buildings with Weak First Stories*. Washington, DC, 336 p.  
[https://www.fema.gov/media-library-data/20130726-1916-25045-2624/femap\\_807.pdf](https://www.fema.gov/media-library-data/20130726-1916-25045-2624/femap_807.pdf) [retrieved November 15, 2018]

(FEMA) Federal Emergency Management Agency (2013a). *Flood Insurance Study-Preliminary: Hudson County, New Jersey (all Jurisdictions)*, Flood Insurance Study Number 34017CV000B.

(FEMA) Federal Emergency Management Agency (2013b). *Including Building Codes in the National Flood Insurance Program: Fiscal Year 2013 Report to Congress Impact Study for Biggert-Waters Flood Insurance Reform Act of 2012*. Washington, DC, 58 p.

(FEMA) Federal Emergency Management Agency (2013c). *Integrating Hazard Mitigation Into Local Planning Case Studies and Tools for Community Officials*, Washington, DC, 84 p. Retrieved from <http://www.gema.ga.gov/Mitigation/Resource%20Document%20Library/Integrating%20Hazard%20Mitigation%20into%20Local%20Planning.pdf>. [accessed 30 January 2017].

(FEMA) Federal Emergency Management Agency (2013d) *Budget*, [https://www.fema.gov/pdf/about/budget/fema\\_fy2013\\_bib.pdf](https://www.fema.gov/pdf/about/budget/fema_fy2013_bib.pdf). [accessed 4 September 2017].

(FEMA) Federal Emergency Management Agency (2014a). *National Flood Insurance Program Floodplain Management Standards Losses Avoided Study*. P-23.

## NATURAL HAZARD MITIGATION SAVES:

(FEMA) Federal Emergency Management Agency (2014b). *Flood Insurance Study: Lancaster County, Virginia and Incorporated Areas*, Flood Insurance Study Number 51103CV000B.

(FEMA) Federal Emergency Management Agency (2014c). *Flood Insurance Study-Revised Preliminary: Palm Beach County, Florida and Incorporated Areas*, Flood Insurance Study Number 12099CV000A.

(FEMA) Federal Emergency Management Agency (2014d). *National Flood Hazard Layer*. Retrieved from <https://msc.fema.gov/portal>.

(FEMA) Federal Emergency Management Agency (2014e). *Phase 3 National Methodology and Phase 2 Regional Study Losses Avoided as a Result of Adopting and Enforcing Hazard-Resistant Building Codes*. Washington, DC, 412 p.

(FEMA) Federal Emergency Management Agency (2014f). *Taking Shelter from the Storm: Building a Safe Room for Your Home or Small Business*. P-320. <https://www.fema.gov/fema-p-320-taking-shelter-storm-building-safe-room-your-home-or-small-business>. [accessed 18 January 2017].

(FEMA) Federal Emergency Management Agency (2014g). FEMA P-312 Homeowner's Guide to Retrofitting: Six Ways to Protect Your Home from Flooding (3rd Edition). Washington, DC, 212 p.

(FEMA) Federal Emergency Management Agency (2015a). *Reducing Flood Risk to Residential Buildings That Cannot Be Elevated. FEMA P-1037*, 12 p. Retrieved from [https://www.fema.gov/media-library-data/1443014398612-4dfc0f86711bc72434b82c4b100a677/revFEMA\\_HMA\\_Grants\\_4pg\\_2015\\_508.pdf](https://www.fema.gov/media-library-data/1443014398612-4dfc0f86711bc72434b82c4b100a677/revFEMA_HMA_Grants_4pg_2015_508.pdf). [accessed 25 January 2017].

(FEMA) Federal Emergency Management Agency (2015b). *Flood Resistant Provisions of the 2015 International Codes*. 51 p. Retrieved from [https://www.fema.gov/media-library-data/1446030649587-10e447987a16b1313253361ed0871a46/2015\\_Icodes\\_Flood\\_Provisions\\_508\\_v2.pdf](https://www.fema.gov/media-library-data/1446030649587-10e447987a16b1313253361ed0871a46/2015_Icodes_Flood_Provisions_508_v2.pdf). [accessed 20 January 2017].

(FEMA) Federal Emergency Management Agency (2015c). *Safe Rooms for Tornadoes and Hurricanes: Guidance for Community and Residential Safe Rooms, Third Edition*. P-361. <https://www.fema.gov/media-library/assets/documents/3140>.

(FEMA) Federal Emergency Management Agency (2015d). *NEHRP Recommended Seismic Provisions for New Buildings and Other Structures (FEMA P-1050-1)*. Federal Emergency Management Agency. Washington, DC. 515 pp.

(FEMA) Federal Emergency Management Agency (2015e). *Rapid Visual Screening of Buildings for Potential Seismic Hazards: A Handbook Third Edition*. P-154. [https://www.fema.gov/media-library-data/1426210695633-d9a280e72b32872161efab26a602283b/FEMAP-154\\_508.pdf](https://www.fema.gov/media-library-data/1426210695633-d9a280e72b32872161efab26a602283b/FEMAP-154_508.pdf).

## NATURAL HAZARD MITIGATION SAVES:

(FEMA) Federal Emergency Management Agency (2016a). *Loss Dollars Paid by Calendar Year*. Retrieved from <https://www.fema.gov/loss-dollars-paid-calendar-year>. [accessed 30 January 2017].

(FEMA) Federal Emergency Management Agency (2016b). *Disaster Relief Funding: FY 2017 Funding Requirements*. February 9, 2016. [https://www.dhs.gov/sites/default/files/publications/FEMA%20-%20Disaster%20Relief%20Fund%20-%20Annual%20Report%20-%20FY%202017%20Funding%20Requirements\\_0.pdf](https://www.dhs.gov/sites/default/files/publications/FEMA%20-%20Disaster%20Relief%20Fund%20-%20Annual%20Report%20-%20FY%202017%20Funding%20Requirements_0.pdf).

(FEMA) Federal Emergency Management Agency (2017a). *Public Assistance Program and Policy Guide, FP 104-009-2*. Washington, DC, 217 p.

(FEMA) Federal Emergency Management Agency (2017b). *FEMA HMGP Property Acquisitions*. Retrieved from <https://www.fema.gov/media-library/assets/documents/85455> [accessed 30 January 2017]

(FEMA) Federal Emergency Management Agency (2017c) *National Flood Hazard Layer*. <https://msc.fema.gov/portal>.

(FEMA) Federal Emergency Management Agency (2017d). *FEMA P-348 Protecting Building Utility Systems from Flood Damage – Principles and Practices for the Design and Construction of Flood Resistant Building Utility System (2<sup>nd</sup> Edition)*. Washington, DC, 178 p.

(FEMA) Federal Emergency Management Agency (2018a). *Mitigation Assessment Team Report. Hurricane Irma in Florida. Building Performance Observations, Recommendations, and Technical Guidance*. FEMA P-2023. 181 p.

(FEMA) Federal Emergency Management Agency (2018b). *National Flood Insurance Program Flood Insurance Manual (October 2018 Edition)*. Washington, DC, 750 p.

(FEMA) Federal Emergency Management Agency (2019a). *Building Code Adoption Tracking System, 4th Quarter 2019*. Washington, DC. (unpublished data, September 25, 2019).

(FEMA) Federal Emergency Management Agency (2019b). *The National Flood Insurance Program Community Status Book, Nation*. Washington, DC, 527 p. Retrieved from <https://www.fema.gov/national-flood-insurance-program-community-status-book>. [accessed October 15, 2019.]

(FHFA) Federal Housing Finance Agency (2018). *Annual Housing Report 2018*. Washington, DC, 46 p. <https://www.fhfa.gov/AboutUs/Reports/Pages/Annual-Housing-Report-2018.aspx> [accessed June 23, 2019]

(FHFA) Federal Housing Finance Agency (2019). News Release FHFA House Price Index Up 0.4 Percent in November. Washington, DC, 1 p.

Federal Reserve Bank of St. Louis. *Gross Domestic Product: Implicit Price Deflator*. <https://fred.stlouisfed.org/series/GDPDEF/>. [accessed 5 December 2017]

Field, E. H., Biasi, G. P., Bird, P., Dawson, T. E., Felzer, K. R., Jackson, D. D., Johnson, K. M., Jordan, T. H., Madden, C., Michael, A. J., Milner, K. R., Page, M. T., Parsons, T., Powers, P. M., Shaw, B. E., Thatcher, W. R., Weldon II, R. J., and Zeng, Y. (2015). Long-term time-dependent probabilities for the third uniform California earthquake rupture forecast (UCERF3). *Bulletin of the Seismological Society of America*, 105 (2A): 1-33, April 2015, doi: 10.1785/0120140093.

Field, E.H., N. Gupta, V. Gupta, M. Blanpied, P. Maechling, and T.H Jordan (2005). Hazard calculations for the WGCEP-2002 forecast using OpenSHA and distributed object technologies. *Seismological Research Letters* 76, 161-167

Finn, D., Chandrasekhar, D., and Xiao Y. (2016). Planning for resilience in the New York metro region after Hurricane Sandy: International and Comparative Perspectives. In book: *Spatial Planning and Resilience Following Disasters* (pp.117-136). Bristol, UK: Policy Press.

Finney, M. A., C. W. McHugh, I. C. Grenfell, K. L. Riley, and K. C. Short. 2011. "A simulation of probabilistic wildfire risk components for the continental United States." *Stoch Environ Res Risk Assess* 25.

FMI Corporation (2017). *U.S. Markets Construction Overview*. Raleigh, NC, 52 p.  
<https://www.fminet.com/special-reports/2017-u-s-markets-construction-overview/> [accessed October 28, 2018]

Fothergill, A., and Peek, L. (2004). Poverty and disasters in the United States: a review of recent sociological findings. *Natural Hazards* 32: 89-110.

Fujisaki, E. (2009). Seismic Design Standards For Electric Substation Equipment. *Proceedings of the 2009 Technical Council On Lifeline Earthquake Engineering Conference*. Am. Soc. Civil Engineers, Oakland.

(GAO) Government Accountability Office (2014). *Hurricane Sandy: FEMA Has Improved Disaster Aid Verification but Could Act to Further Limit Improper Assistance*. GAO 15-15. December 2014.  
<http://www.gao.gov/assets/670/667469.pdf>.

Government Publishing Office (2016). Federal Register Notices, 81: 5487- 5488. Retrieved from  
<https://www.gpo.gov/fdsys/pkg/FR-2016-02-02/pdf/2016-01604.pdf> [accessed 24 September 2017].

Haimes, Y.Y. and Jiang P. (2001). Leontief-Based Model of Risk in Complex Interconnected Infrastructures. *Journal of Infrastructure Systems*, 7, 1-12.

Haimes, Y.Y., Horowitz, B.M., Lambert, J.H., Santos, J.R., Crowther, K., and Lian C. (2005). Inoperability input-output model for interdependent infrastructure sectors. I: theory and methodology. *Journal of Infrastructure Systems*, 11, 67-79.

## NATURAL HAZARD MITIGATION SAVES:

Hakes, R.S.P., Caton, S.E., Gorham, D.J., and Gollner, M.J. (2017). A review of pathways for building fire spread in the wildland urban interface part ii: response of components and systems and mitigation strategies in the United States. *Fire Technology* 53 (2): 475-515.

Han, T.-x., L.-h. LI, and Y.-h. YU (2007). *Economy evaluation for 500 kV substation retrofits by using LCC* [J]. East China electric power 8:004.

Hawkesbury-Nepean Floodplain Management Steering Committee (2006). *Reducing Vulnerability of Buildings to Flood Damage – Guidance on Building in Flood Prone Areas*. Parramatta, New South Wales, Australia, 162 p.

Henneaux, P., P.-E. Labeau, and J.-C. Maun (2011). Towards an integrated probabilistic analysis of the blackout risk in transmission power systems. Pages 1149-1160 in *Proc. ANS PSA 2011 Int. Topical Meeting on Probabilistic Safety Assessment and Analysis*.

Himoto, K., and Tanaka, T. (2008). Development and validation of a physics-based urban fire spread model. *Fire Safety Journal* 43: 477-494.

Hines, P., J. Apt, and S. Talukdar (2008). Trends in the history of large blackouts in the United States. Pages 1-8 in *Power and Energy Society General Meeting–Conversion and Delivery of Electrical Energy in the 21st Century*, 2008 IEEE. IEEE.

Holling, C. (1973). Resilience and stability of ecological Systems. *Annual Review of Ecology and Systematics*, 4, 1–23.

Hosseini, A. H. K. a. M. (2009). Seismic Performance Of Electrical Substations' Equipment In Bam Earthquake (Iran ). *Proceedings of the 2009 Technical Council On Lifeline Earthquake Engineering Conference*. Am. Soc. Civil Engineers, Oakland.

Hosseini, M., A. Raoufi, A. H. Khalvati, and a. A. Soroor (2009). A Seismic Risk Management Model For Electric Power Distribution Networks In Large Cities By Concentration On Low-Voltage Substations. *Proceedings of the 2009 Technical Council On Lifeline Earthquake Engineering Conference*. Am. Soc. Civil Engineers, Oakland.

Housner, G.W. (1994). *The Continuing Challenge-The Northridge Earthquake of January 17, 1994. Report to the Director, California Department of Transportation by the Seismic Advisory Board*.

IAWF (2013). *WUI Fact Sheet*. Pp. 11. Missoula: International Association of Wildland Fire. Updated August 1, 2013, Used by permission from ICC and NARCD Councils from the national program Wildfire, Safe, Sound and Code Smart® program. This document is a condensed version of the original document.

[http://www.iawfonline.org/pdf/WUI\\_Fact\\_Sheet\\_08012013.pdf](http://www.iawfonline.org/pdf/WUI_Fact_Sheet_08012013.pdf).



## NATURAL HAZARD MITIGATION SAVES:

IBM (2016). *Federal Emergency Management Agency (FEMA) Enterprise Applications Development Integration and Sustainment (EADIS) Task Order HSFEHQ-08-J-2009 Public Assistance (PA) System Design Document Work Order 05 – Enterprise Data Warehouse (EDW) Version 3.7 August 9, 2016*. FEMA, Washington, DC, 157 pp.

IEEE 693 (2005). *Recommended Practice for Seismic Design of Substations*. IEEE Power Engineering Society Sponsored by the Substations Committee, New York.

Independent Sector (2019). *Value of Volunteer Time 2018*. Washington, DC, <https://independentsector.org/value-of-volunteer-time-2018/> [retrieved February 6, 2019]

International Code Council (2017). *2018 International Wildland-Urban Interface Code*. Washington, DC, 53 p.

Insurance.com (2018). Personal property insurance: Why you need it and how to pay less. <https://www.insurance.com/home-and-renters-insurance/personal-belongings/content-insurance.aspx>

Insurance Information Institute (2018). *Hurricane Andrew Fact Sheet*. <https://www.iii.org/article/hurricane-andrew-fact-sheet> [accessed December 9, 2018]

(IBHS) Insurance Institute for Business & Home Safety (ND). The Benefits of Modern Wind Resistant Building Codes on Hurricane Claim Frequency and Severity A Summary Report. 6 p. [http://nhma.info/uploads/resources/BC\\_kit\\_final.pdf](http://nhma.info/uploads/resources/BC_kit_final.pdf)

(IBHS) Insurance Institute for Business & Home Safety (2012). *FORTIFIED HOME Hurricane Standards*. <https://disastersafety.org/wp-content/uploads/fortified-home-hurricane-standards.pdf>

(IBHS) Insurance Institute for Business & Home Safety (2015). *FORTIFIED HOME High Wind Standards*. <http://disastersafety.org/wp-content/uploads/2015/07/FORTIFIED-High-Wind-Standards-2015.pdf>.

Institute for Building Technology and Safety (2005). *An Assessment of Damage to Manufactured Homes Caused by Hurricane Charley*. Herndon, Virginia, 64 p. <https://www.huduser.gov/Publications/pdf/HurricaneCharley04.pdf> [accessed June 10, 2019]

(ICC) International Code Council (2000a). *International Building Code*, Falls Church VA

(ICC) International Code Council (2000b). *International Residential Code*, Falls Church VA

(ICC) International Code Council (2014a). *ICC/NSSA Standard for the Design and Construction of Storm Shelters. Standard ICC 500-2014*, Falls Church VA

(ICC) International Code Council (2014b). *Standard for the Residential Construction in High-Wind Regions. Standard ICC 600-2014*, Falls Church VA

## NATURAL HAZARD MITIGATION SAVES:

(ICC) International Code Council (2014c). *Reducing Flood Losses Through the International Codes®: Coordinating Building Codes and Floodplain Management Regulations, 4<sup>th</sup> edition*. Washington, DC, 150 p., [https://www.fema.gov/media-library-data/1411731781834-d0c7d7f9ff0d195ce3c33901ba73daac/ReducingFloodLosses\\_4thED\\_Final\\_508.pdf](https://www.fema.gov/media-library-data/1411731781834-d0c7d7f9ff0d195ce3c33901ba73daac/ReducingFloodLosses_4thED_Final_508.pdf) [accessed 29 January 2017].

(III) Insurance Information Institute (2006-2015) *Components of The Combined Ratio, Property/Casualty Insurance, 2006-2015 (1)*, <https://www.iii.org/table-archive/21061>. [accessed 20 June 2017].

(ICC) International Code Council (2015a). *2015 International Building Code*. Country Club Hills, IL, 700 pp.

(ICC) International Code Council (2015b). *2015 International Residential Code for One- and Two-Family Dwellings*. Falls Church, VA, 932 pp.

(ICC) International Code Council (2015c). *2015 International Wildland-Urban Interface Code*. Falls Church, VA, 74 pp.

(ICC) International Code Council (2015d). *2015 International Existing Building Code*. Falls Church, VA, 304 pp.

(ICBO) International Conference of Building Officials (1927). *Uniform Building Code*. Long Beach, CA, 256 pp.

(IPCC) Intergovernmental Panel on Climate Change (1992). *Climate Change 1992*. Houghton, J. T., and Callander, B. A., eds., Cambridge University Press.

(IPCC) Intergovernmental Panel on Climate Change (1995). *Climate Change 1995: The Science of Climate Change: Contribution of Working Group I to the Second Assessment Report of the Intergovernmental Panel on Climate Change* (Vol. 2). Houghton, J. T., ed. Cambridge University Press.

(IPCC) Intergovernmental Panel on Climate Change (2001). *Contribution of Working Groups I, II and III to the Fourth Assessment Report of the Intergovernmental Panel on Climate Change*. Core Writing Team, Watson, R. T., and Albritton, D. L. eds., Cambridge University Press.

(IPCC) Intergovernmental Panel on Climate Change (2007). *Contribution of Working Groups I, II and III to the Fourth Assessment Report of the Intergovernmental Panel on Climate Change*. Core Writing Team, Pachauri, R.K. and Reisinger, A. (Eds.), IPCC, Geneva, Switzerland. 104 pp.

(IPCC) Intergovernmental Panel on Climate Change (2014). *Climate Change 2014: Synthesis Report. Contribution of Working Groups I, II and III to the Fifth Assessment Report of the Intergovernmental Panel on Climate Change* [Core Writing Team, R.K. Pachauri and L.A. Meyer (eds.)]. IPCC, Geneva, Switzerland, 151 pp. [https://www.ipcc.ch/pdf/assessment-report/ar5/syr/SYR\\_AR5\\_FINAL\\_full\\_wcover.pdf](https://www.ipcc.ch/pdf/assessment-report/ar5/syr/SYR_AR5_FINAL_full_wcover.pdf). [accessed 25 January 2017].

Isard, W. (1960). *Methods of regional analysis: An introduction to regional science*. Cambridge, MA: MIT Press.

Jennings, P.C. and Wood, J.H. (1971). *Earthquake Damage to Freeway Structures, Engineering Features of the San Fernando Earthquake of February 9, 1971*. California Institute of Technology, pp. 366–385.

Jones, B. A, Thacher, J.A., Chermak, J.M., and Berrens, R.P. (2016). Wildfire smoke health costs: a methods case study for a Southwestern US 'mega-fire.' *Journal of Environmental Economics and Policy* 5(2):181-99.

Jones, C.P., Coulbourne, W.L., Marshall, J., and Rogers, Jr, S.M. (2006). *Evaluation of the National Flood Insurance Program's Building Standards*, Durham, NC, 118p. Retrieved from [https://www.fema.gov/media-library-data/20130726-1602-20490-5110/nfip\\_eval\\_building\\_standards.pdf](https://www.fema.gov/media-library-data/20130726-1602-20490-5110/nfip_eval_building_standards.pdf). [accessed 13 January 2017].

Jones, L.M., Bernknopf, R., Cox, D., Goltz, J., Hudnut, K., Mileti, D., Perry, S., Ponti, D., Porter, K., Reichle, M., Seligson, H., Shoaf, K., Treiman, J. and Wein, A. (2008). *The Shakeout Scenario*. 312 pp. Reston, VA.: USGS Open File Report 2008-1150, U.S. Geologic Survey.

Kempner Jr., L. (2008). *Substation structure design guide*. American Society of Civil Engineers.

Kempner Jr., L. (2009). ASCE Guide For Design Of Substation Structures. *Proceedings of the 2009 Technical Council On Lifeline Earthquake Engineering Conference*. Am. Soc. Civil Engineers, Oakland.

Kenny, J.F., and K.E. Juracek (2012). *Description of 2005-2010 Domestic Water use for Selected U.S. Cities and Guidance for Estimating Domestic Water Use*. 31 pp. U.S. Geological Survey.

Kirtman, B., Power, S.B., Adedoyin, J.A., Boer, G. J., Bojariu, R., Camilloni, I., Doblas-Reyes, F.J., Fiore, A.M., Kimoto, M., Meehl, M., Prather, M., Sarr, A., Schär, C., Sutton, R., van Oldenborgh, G. J., Vecchi G., and Wang, H.J. (2013). Near-term climate change: projections and predictability. In Stocker, T.F., D. Qin, G.-K. Plattner, M. Tignor, S.K. Allen, J. Boschung, A. Nauels, Y. Xia, V. Bex and P.M. Midgley, eds.,

*Climate Change 2013: The Physical Science Basis. Contribution of Working Group I to the Fifth Assessment Report of the Intergovernmental Panel on Climate Change*. Cambridge University Press, Cambridge, United Kingdom and New York, NY, USA.

Knight, B. T., and L. Kempner (2009). Seismic Vulnerabilities And Retrofit Of High-Voltage Electrical Substation Facilities. *Proceedings of the 2009 Technical Council On Lifeline Earthquake Engineering Conference*. Am. Soc. Civil Engineers, Oakland.

Knutson, T.R., McBride, J.L., Chan, J., Emanuel, K., Holland, G., Landsea, C., Held, I., Kossin, J.P., Srivastava, A.K., and Sugi, M. (2010). Tropical cyclones and climate change. *Nature Geoscience*, 3(3), 157-163.

Kochi, I., Donovan, G.H., Champ, P.A., and Loomis, J.B. (2010). The economic cost of adverse health effects from wildfire-smoke exposure: a review. *International Journal of Wildland Fire* 19(7):803-17.

Konstantinidis, D., and Makris, N. (2010). Experimental and analytical studies on the response of 1/4-scale models of freestanding laboratory equipment subjected to strong earthquake shaking. *Bulletin of Earthquake Engineering* 8:1457–1477

Koo, E., Pagni, P.J., Weise, D.R., and Woycheese, J.P. (2010). Firebrands and spotting ignition in large-scale fires. *International Journal of Wildland Fire*, 19: 818–843.

Kousky, C. A. (2017). Discussion of the national flood insurance program. *Resources for the Future RFF—Policy Brief*, 17-01, 30 p. National Oceanic and Atmospheric Administration (2018). *Billion-Dollar Disasters: Calculating the Costs - 7 Things to Know about NCEI's U.S. Billion-Dollar Disasters Data*.

<https://www.ncdc.noaa.gov/monitoring-references/dyk/billions-calculations> [retrieved March 11, 2019]

Kousky, C., and Walls, M. (2014). Floodplain conservation as a flood mitigation strategy: Examining costs and benefits. *Ecological Economics*. 104: 119-128.

Krawinkler, H., Aslani, H., Baker, J., Cornell, C.A., Heintz, J., Hutchinson, T., Ince, U., Kramer, S., Kutter, B., Lowes, L., Martin, G., Meszaros, J., Miranda, E., Nagae, T., Pekelnicky, R., Porter, K., Shoaf, K., Seligson, H., Somerville, P., and Zareian, F. (2005). Van Nuys Hotel Building Testbed Report: Exercising Seismic Performance Assessment, Report 2005-11, Pacific Earthquake Engineering Research Center, Richmond, CA, [http://peer.berkeley.edu/publications/peer\\_reports/reports\\_2005/PEER\\_511\\_KRAWINKLER\\_testbed.pdf](http://peer.berkeley.edu/publications/peer_reports/reports_2005/PEER_511_KRAWINKLER_testbed.pdf).

Krayer, W.R., and Marshall, R.D. (1992). Gust factors applied to hurricane winds. *Bull. Am. Meteorol. Soc.*, 73 (5), 613–617.

Krumholz, H.M., Nuti, S.V., Downing, N.S., Normand, S.-L.T., & Wang, Y. (2015). Mortality, hospitalizations, and expenditures for the Medicare population age 65 and older, 1999–2013. *Journal of the American Medical Association*, 314(4), 355–365. <http://doi.org/10.1001/jama.2015.8035>

Küfeoğlu, S., and M. Lehtonen (2015). Interruption costs of service sector electricity customers, a hybrid approach. *International Journal of Electrical Power & Energy Systems* 64:588-595.

Kundzewicz, Z.W., Luger, N., Dankers, R., Hirabayashi, Y., Döll, P., Pińskwar, I., Dysarz, T., Hochrainer, S., and Matczak, P. (2010). Assessing river flood risk and adaptation in Europe - review of projections for the future. *Mitigation and Adaptation Strategies for Global Change*. 15 (7): 641-656.

LaCommare, K. H., and J. H. Eto (2006). Cost of power interruptions to electricity consumers in the United States (US). *Energy* 31:1845-1855.

Lajoie, K., and Keefer, D. (1981). *Investigations of the 8 November 1980 Earthquake in Humboldt County, California (No. 81-397)*. U.S. Geological Survey.

Larsen, P. H., B. Boehlert, J. Eto, K. Hamachi-LaCommare, J. Martinich, and L. Rennels (2017). Projecting Future Costs to US Electric Utility Customers from Power Interruptions. *Energy*.

Lee, S., Davidson, R., Ohnishi, N., and Scawthorn, C. (2008). Fire following earthquake, reviewing the state-of-the-art of modeling. *Earthquake Spectra* 24 (4): 933-967.

Leontief, W. (1936). Quantitative input and output relations in the economic system of the United States. *Review of Economics and Statistics*, 18, 105-125.

Lew, H.S. (1987). *The Whittier Narrows Earthquake of October 1, 1987: A Reconnaissance Report*. U.S. National Bureau of Standards.

Lew, H.S. (Ed.). (1990). *Performance of Structures during the Loma Prieta Earthquake of October 17, 1989 (Vol. 778)*. U.S. Dept. of Commerce, National Institute of Standards and Technology.

Lian C., Santos, J.R., and Haimes, Y.Y. (2007). Extreme risk analysis of interdependent economic and infrastructure sectors, *Risk Analysis, an International Journal*, 27, 1053-1064.

Lian, C., and Haimes, Y.Y. (2006). Managing the risk of terrorism to interdependent infrastructure systems through the dynamic inoperability input-output model. *Systems Engineering*, 9, 241-258.

Life Insurance Selling Magazine (2013). *Life Insurance by the Numbers*. August 26, 2013. <http://www.thinkadvisor.com/2013/08/26/life-insurance-by-the-numbers>. [accessed 6 December 2017].

LIMRA (2016). *Life Insurance Ownership in Focus (2016)*. September 28, 2016. <http://www.limra.com/ownership/>. [accessed 6 December 2017].

Lin, S., B. A. Fletcher, M. Luo, R. Chinery, and S.-A. Hwang (2011). Health Impact in New York City during the Northeastern Blackout of 2003. *Public Health Reports* 126 384-393.

Line, P. (2006) Benchmarking seismic base shear to historical practice. *American Wood Council*. 5:9-13

Luco, N., Ellingwood, B.R., Hamburger, R.O., Hooper, J.D., Kimball, J.K. and Kircher, C.A. (2007). Risk-targeted versus current seismic design maps for the conterminous United States. *Structural Engineers Association of California 2007 Convention Proceedings, 26-29 Sep 2007, Lake Tahoe CA*, 163-175.

Maass, A., Hufschmidt, M.M., Dorfman, R., Thomas, Jr., H.A., Marglin S.A., and Maskew Fair, G., (1962). *Design of Water-Resource Systems: New Techniques for Relating Economic Objectives, Engineering Analysis, and Governmental Planning*, Cambridge, MA, Harvard University Press.

Makris N. and J. Zhang (1999). *Rocking Response and Overturning of Anchored Equipment Under Seismic Excitations*, Report No. PEER-1999/06, Pacific Earthquake Engineering Research Center, University of California, Berkeley, CA, November 1999, <http://peer.berkeley.edu/Products/PEERReports/reports-1999/9906.pdf>

Mander, J.B. and Basoz, N. (1999). Seismic fragility curves for highway bridges. optimizing post-earthquake lifeline system reliability. *Proceedings of the 5th U.S. National Conference on Lifeline Earthquake Engineering*. Technical Council on Lifeline Earthquake Engineering Monograph No. 16, pp 31-40.

Manufactured Housing Research Alliance (2002). *Guide to Foundation and Support Systems for Manufactured Homes*. Prepared for the U.S Department of Housing and Urban Development, Office of Policy Development and Research. Washington, DC.

Manzello, S. L., Cleary, T. G., Shields, J. R., and Yang, J. C. (2006a). Ignition of mulch and grasses by firebrands in wildland-urban interface fires. *International Journal of Wildland Fire* 15: 427-431.

Manzello, S. L., Cleary, T. G., Shields, J. R., and Yang, J. C. (2006b). On the ignition of fuel beds by firebrands. *Fire and Materials* 30 (1): 77-87.

Manzello, S. L., Cleary, T.G., Shields, J.R., and Yang, J.C. (2005). Urban-wildland fires: on the ignition of surfaces by embers. In Turns, S., ed. *Proceedings of the 4th Joint Meeting of the U.S. Sections of Combustion Institute*.

Manzello, S. L., Shields, J. R. and Cleary, T. G. (2005). *Ignition of Mulch by Firebrands in Wildland/Urban Interface (WUI) Fires*.

Mar, D., and Korolyk, M. (2012). FEMA P-807: Guidelines for Seismic Retrofit of Weak-Story Wood-Framed Buildings. *Proc, 15<sup>th</sup> World Conference on Earthquake Engineering, Lisbon, Portugal, September 2012*, 10 p. [http://www.iitk.ac.in/nicee/wcee/article/WCEE2012\\_5431.pdf](http://www.iitk.ac.in/nicee/wcee/article/WCEE2012_5431.pdf) [retrieved November 15, 2018]

Maranghides, A., McNamara, D., Vihnanek, R., Restaino, J., and Carrie Leland Excet, I. S., VA. 2015. *A Case Study of a Community Affected by the Waldo Fire - Event Timeline and Defensive Actions: 227*: NIST Technical Note 1910, This publication is available free of charge from: <http://dx.doi.org/10.6028/NIST.TN.1910>.

Martinuzzi, S., Stewart, S.I., Helmers, D.P., Mockrin, M.H., Hammer, R.B., and Radeloff, V.C. (2015a). *The 2010 Wildland-Urban Interface of the Conterminous United States - Geospatial Data*. Fort Collins, CO: Forest Service Research Data Archive. <https://doi.org/10.2737/RDS-2015-0012>.

Martinuzzi, S., Stewart, S.I., Helmers, D.P., Mockrin, M.H., Hammer, R.B., and Radeloff, V.C. (2015b). *The 2010 Wildland-Urban Interface of the Conterminous United States*. 124 p. Newtown Square, PA: U.S. Department of Agriculture, Forest Service, Northern Research Station.

Matthewman, S., and H. Byrd (2014). Blackouts: A Sociology of Electrical Power Failure. *Social Space*:1 - 25.

Mayes, R.L., Jones, L.R., and Kelly, T.E. (1990). The economics of seismic isolation in buildings. *Earthquake Spectra*, 6(2), 245-263.

## NATURAL HAZARD MITIGATION SAVES:

Mayoral Seismic Task Force (2015). *Resilience by Design – Building a Stronger Los Angeles*. City of Los Angeles, California, 15 p.

McMahon T.M., and Friedman, D.J. (2016). Havoc in the supply chain tests business interruption policies. *Business Insurance*, 27 Mar 2016, <http://www.businessinsurance.com/article/00010101/STORY/303279991/Havoc-in-the-supply-chain-tests-business-interruption-policies>. [accessed 15 October 2017].

Mell, W.E., Manzello, S.L., Maranghides, A., Butry, D., and Rehm, R.G. (2010). The wildland–urban interface fire problem—current approaches and research needs. *International Journal of Wildland Fire*, 19(2), 238-251.

Miller, H. C. (1990). *Hurricane Hugo: Learning from South Carolina*. Prepared for the Office of Ocean and Coastal Resource Management, National Ocean Service, National Oceanic and Atmospheric Administration, U.S. Department of Commerce. p. 6-8

Miller, R.E., and Blair, P.D. (2009). *Input-output Analysis: Foundations and Extensions, 2nd ed.* NJ: Cambridge University Press.

Minute Man Anchors, Inc. (2015). Engineered Tie Down System Design and General Notes. East Flatrock, North Carolina, 2 p. <http://minutemanproducts.com/minute-man-products/docs/western-states-engineering-2016-17.pdf> [retrieved December 13, 2018]

Mozumder, P., Helton, R., and Berrens, R.P. (2009). Provision of a wildfire risk map: informing residents in the wildland urban interface. *Risk Analysis: An International Journal* 29(11):1588-600.

Mullin, E. (2013). "How to Pay for Nursing Home Costs." *U.S. News and World Report*. February 26, 2013. <https://health.usnews.com/health-news/best-nursing-homes/articles/2013/02/26/how-to-pay-for-nursing-home-costs>. [accessed 5 December 2017].

(MMC) Multihazard Mitigation Council. (2005). *Natural Hazard Mitigation Saves: An Independent Study to Assess the Future Savings from Mitigation Activities*. National Institute of Building Sciences, Washington, DC.

(MMC) Multihazard Mitigation Council (2018). *Natural Hazard Mitigation Saves 2017 Interim Report: An Independent Study*—330 p. Washington: National Institute of Building Sciences. Principal Investigator: Porter, K.; co-Principal Investigators Scawthorn, C.; Dash, N.; Santos, J.; P. Schneider, Director, MMC.,.

Multihazard Mitigation Council (2018). *Natural Hazard Mitigation Saves 2017 Interim Report: An Independent Study*. National Institute of Building Sciences. Principal Investigator: Porter, K.; co-Principal Investigators Scawthorn, C.; Dash, N.; Santos, J.; P. Schneider, Director, MMC, Washington.

(MMC and CFIRE) Multihazard Mitigation Council and Council on Finance, Insurance, and Real Estate (2015). *Developing Pre-Disaster Resilience Based on Public and Private Incentivization*. National Institute of

## NATURAL HAZARD MITIGATION SAVES:

Building Sciences, Washington, DC, 57 p.

[https://www.nibs.org/resource/resmgr/MMC/MMC\\_ResilienceIncentivesWP](https://www.nibs.org/resource/resmgr/MMC/MMC_ResilienceIncentivesWP). [accessed 16 October 2017].

NASA Jet Propulsion Laboratory (2017). *Scientific Consensus: Earth's Climate is Warming*. Pasadena CA, 15 p. <http://climate.nasa.gov/scientific-consensus/> [accessed January 25, 2017].

National Academies of Sciences, Engineering, and Medicine (2017). *Valuing Climate Damages: Updating Estimation of the Social Cost of Carbon Dioxide*. National Academies Press, Washington, DC, 281 p.

NAHB Research Center, Inc. (1998). *Factory and Site-Built Housing, A Comparison for the 21st Century*. Prepared for the U.S Department of Housing and Urban Development, Office of Policy Development and Research. Washington, DC.

(NAHB) National Association of Homebuilders (2015). *Cost of Constructing a Home*. <https://www.nahbclassic.org/generic.aspx?genericContentID=248306> [accessed 22 December 2017].

National Board of Fire Underwriters (1905). *National Building Code*. American Insurance Association, Engineering and Safety Service. New York, NY

National Center for Environmental Economics (2010). *Guidelines for Preparing Economic Analyses*, Office of Policy, United States Environmental Protection Agency. December 17, 2010.

National Council on Building Codes and Standards (2018). *Benefits and Challenges of a Timely Code Adoption Cycle*. National Institute of Building Sciences, Washington, DC. 5 p. [https://cdn.ymaws.com/www.nibs.org/resource/resmgr/ncgbcs/NCBCS\\_TimelyCodeAdoption.pdf](https://cdn.ymaws.com/www.nibs.org/resource/resmgr/ncgbcs/NCBCS_TimelyCodeAdoption.pdf) [accessed December 9, 2018]

National Fire Protection Association (2013). *White Paper on Upholstered Furniture Flammability*. Quincy, MA, 32 pp.

(NOAA NHC) National Oceanic and Atmospheric Administration, National Hurricane Center. *Storm Surge Maximum of the Maximum*. National Oceanic and Atmospheric Administration, Retrieved 2014 from <http://www.nhc.noaa.gov/surge/momOverview.php>.

National Interagency Fire Center (2018a). *National Year-to-Date Report on Fires and Acres Burned by State and Agency for 12/07/2018*. 9 p. <https://gacc.nifc.gov/sacc/predictive/intelligence/NationalYTDbyStateandAgency.pdf> [accessed December 9, 2018]

National Interagency Fire Center (2018b). *National Large Incident Year-to-Date Report Report Date: 12/07/2018*. 73 p. <https://gacc.nifc.gov/sacc/predictive/intelligence/NationalLargeIncidentYTDReport.pdf> [accessed December 9, 2018]



## NATURAL HAZARD MITIGATION SAVES:

(NOAA) National Oceanic and Atmospheric Administration. (2017a). *Sea Level Rise Data*. Retrieved May 2017 from <https://coast.noaa.gov/slrdata/>.

(NOAA) National Oceanic and Atmospheric Administration. (2017b). *Billion-Dollar Weather and Climate Disasters: Table of Events*. <https://www.ncdc.noaa.gov/billions/events/US/1980-2017>. [accessed 21 December 2017].

(NOAA GFDL) National Oceanic and Atmospheric Administration Geophysical Fluid Dynamics Laboratory (2016) *Global Warming and Hurricanes An Overview of Current Research Results*. <https://www.gfdl.noaa.gov/global-warming-and-hurricanes/> [last accessed 3 February 2017].

National Park Service (2018). *NPS Annual Visits Report 2008-2017*. <https://irma.nps.gov>.

(NOAA NWS) National Oceanic and Atmospheric Administration National Weather Service (2017). *Storm Events Database*. National Oceanic and Atmospheric Administration, <https://www.ncdc.noaa.gov/stormevents/ftp.jsp>.

NEHRP Consultants Joint Venture (2013). *Cost Analyses and Benefit Studies for Earthquake-Resistant Construction in Memphis, Tennessee*. NIST GCR 14-917-26. National Institute of Standards and Technology, Gaithersburg, MD, 249 pp.

Networx (2011). *How Much Does a Permanent Wheelchair Ramp Cost?* <http://www.networx.com/article/wheelchair-ramp-cost>. [accessed December 6, 2017].

Neudorf, E. G., D. L. Kiguel, G. A. Hamoud, B. Porretta, W. M. Stephenson, R. Sparks, D. Logan, M. Bhavaraju, R. Billinton, and D. Garrison (1995). Cost-benefit analysis of power system reliability: two utility case studies. *IEEE Transactions on Power Systems* 10:1667-1675.

Newmark, N.M. and Hall, W.J. (1982). *Earthquake Spectra and Design*, EERI Monograph MNO-3, Earthquake Engineering Research Institute, Oakland, California.

Newnan, D.G. (1983). *Engineering Economic Analysis, 2<sup>nd</sup> Edition*. Engineering Press, Inc., San Jose, CA, 520 p.

Newnan, D.G., Whittaker, J., Eschenbach, T.G., and Lavelle, J.P. (2006). *Engineering Economic Analysis, Canadian Edition*. Oxford University Press Canada, Don Mills, Ontario, 600 p.

NIST (1995). *Recommended Performance-Based Criteria for the Design of Manufactured Home Foundation Systems to Resist Wind and Seismic Loads*. <http://fire.nist.gov/bfrlpubs/build95/PDF/b95084.pdf>.

NIST (2015). *Seismic Design of Steel Buckling-Restrained Braced Frames: A Guide for Practicing Engineers*, GCR 15-917-34, NEHRP Seismic Design Technical Brief No. 11, produced by the Applied Technology Council and the Consortium of Universities for Research in Earthquake Engineering for the National

## NATURAL HAZARD MITIGATION SAVES:

Institute of Standards and Technology, Gaithersburg, MD.

<http://nvlpubs.nist.gov/nistpubs/gcr/2015/NIST.GCR.15-917-34.pdf> [accessed 17 October 2017].

(NCSU) North Carolina State University College of Design, Center for Universal Design (2004). *Wood Ramp Design: How to Add a Ramp that Looks Good and Works Too*.

[https://projects.ncsu.edu/ncsu/design/cud/pubs\\_p/docs/rampbooklet296final.pdf](https://projects.ncsu.edu/ncsu/design/cud/pubs_p/docs/rampbooklet296final.pdf).

Nowak, A.S. (Ed.). (2012). *Bridge Evaluation, Repair and Rehabilitation* (Vol. 187). Springer Science & Business Media.

O'Connor, J., (2004). Survey on actual service lives for North American buildings. *Proc. Woodframe Housing Durability and Disaster Issues Conference, Las Vegas, NV October 2004*, [http://cwc.ca/wp-content/uploads/2013/12/DurabilityService\\_Life\\_E.pdf](http://cwc.ca/wp-content/uploads/2013/12/DurabilityService_Life_E.pdf). [accessed 16 Mar 2017].

Oakeshott, G. B. (1975). *San Fernando, California, Earthquake of 9 February 1971* (Vol. 196). California Division of Mines and Geology.

Oakland City Council (2009). *Ordinance Number 12966 C.M.S. an Ordinance Amending the Oakland Municipal Code and Adding a New Chapter 15.26 Entitled Mandatory Seismic Screening of Certain Multiple Story Residential Buildings Permitted for Construction Prior to the Adoption by the State of California on January 1,1991, of the 1988 Edition Of The Uniform Building Code*. Oakland, California, 12 p.

<https://oakland.legistar.com/LegislationDetail.aspx?ID=748540&GUID=7287224A-4303-4043-94F2-815721E161BE> [retrieved November 14, 2018]

OES, 1994. *Northridge Earthquake January 17, 1994 Interim Report*. California Governor's Office of Emergency Services, Sacramento, CA.

Oikonomou, K., M.C. Constantinou, A.M. Reinhorn, and L. Kempner Jr. (2016). Seismic isolation of high voltage electrical power transformers. *Technical report MCEER-16-0010*, Multidisciplinary Center for Earthquake Engineering Research, University at Buffalo, Buffalo, NY Google Scholar.

Oklahoma Uniform Building Code Commission (2016). *Rules 748 - Uniform Building Code Commission, Adopted Codes, International Residential Code®, 2015 Edition (IRC®, 2015), 748:20-5-1 through 748:20-5-28*. <https://www.ok.gov/oubcc/documents/Permanent%20Rule%20IRC%202015.pdf> [viewed 14 November 2016].

Oliver Technologies, Inc. (2007). *Engineered Tie Down System*. 11 p.

[http://www.olivertechnologies.com/states/CALIFORNIA/California%20Approval%20Package/archive/Engineer%20Tie%20Down%20System%20Exp%2003\\_31\\_07.pdf](http://www.olivertechnologies.com/states/CALIFORNIA/California%20Approval%20Package/archive/Engineer%20Tie%20Down%20System%20Exp%2003_31_07.pdf) [retrieved December 13, 2018]

Olshansky, R.B., Bancroft, R., and Glick, C. (1998): *Promoting the Adoption and Enforcement of Seismic Building Codes: a Guidebook for State Earthquake and Mitigation Managers*. FEMA 313. Federal Emergency Management Agency, Washington, DC, 211 p.

(OMB) Office of Management and Budget (2003). *Circular A-4*.

(OSM) OpenStreetMap (2017). *OpenStreetMap Building Footprints*. Retrieved May 2017 from <https://www.openstreetmap.org>.

Organisation for Economic Co-operation and Development ((OECD) "2016) SF1.1 family size and composition," in *OECD Family Database*.  
[http://www.oecd.org/els/family/SF\\_1\\_1\\_Family\\_size\\_and\\_composition.pdf](http://www.oecd.org/els/family/SF_1_1_Family_size_and_composition.pdf). [accessed 5 December 2017].

O'Rourke, M. , and Liu, X. (2012). *Seismic Design of Buried and Offshore Pipe*. Buffalo, NY: MCEER.

O'Rourke, T.D., Scawthorn, C.R., Blackburn, F.T., and Dickerman, T.S. (1990). Response of the San Francisco water supply system during the 1989 Loma Prieta earthquake. *Putting the Pieces Together*. San Francisco, CA.

Orsi, M.J., and Santos, J.R. (2010). Probabilistic modeling of workforce-based disruptions and input-output analysis of interdependent ripple effects. *Economic Systems Research*, 22, 3-18.

Pagni, P.J., and Woycheese, J.P., (2000). Fire spread by brand spotting. In Bryner, S.L., ed. *U.S./Japan Government Cooperative Program on Natural Resources (UJNR). Fire Research and Safety. 15th Joint Panel Meeting. Volume 2. Proceedings, San Antonio, TX.* p. 373-380.

Park, C.S., Kim, G., and Choi, S. (2007). *Engineering economics*. Pearson Prentice Hall, New Jersey.

Penman, T.D., Eriksen, C.E., Horsey, B., and Bradstock, R.A. (2016). How much does it cost residents to prepare their property for wildfire? *International Journal of Disaster Risk Reduction* 16:88-98.

Penman, T.D., Eriksen, C., Horsey, B., Green, A., Lemcke, D., Cooper, P., and Bradstock, R.A. (2017). Retrofitting for wildfire resilience: What is the cost? *International Journal of Disaster Risk Reduction* 21:1-10.

Perrings, C. (2001). Resilience and sustainability. In H. Folmer, H.L. Gabel, S. Gerking, A. Rose (Eds.), *Frontiers of Environmental Economics*. Cheltenham, pp. 319–41. U.K.: Edward Elgar.

Petersen, M.D., Moschetti, M.P., Powers, P.M., Mueller, C.S., Haller, K.M., Frankel, A.D., Zeng, Yuehua, Rezaeian, Sanaz, Harmsen, S.C., Boyd, O.S., Field, Ned, Chen, Rui, Rukstales, K.S., Luco, Nico, Wheeler, R.L., Williams, R.A., and Olsen, A.H. (2014). Documentation for the 2014 update of the United States national seismic hazard maps: U.S. Geological Survey Open-File Report 2014–1091, 243 p.,  
<http://dx.doi.org/10.3133/ofr20141091>.

Porter, K. (2017). *A Beginner's Guide to Fragility, Vulnerability, and Risk*. SPA Risk LLC and University of Colorado Boulder, 95 pp., <http://www.sparisk.com/pubs/Porter-beginners-guide.pdf>.

Porter, K., Shoaf, K., and Seligson, H. (2006). Value of injuries in the Northridge earthquake. *Earthquake Spectra* 22 (2): 555-563.

Porter, K.A. (2000). *Assembly-Based Vulnerability of Buildings and its Uses in Seismic Performance Evaluation and Risk-Management Decision-Making*, Doctoral Dissertation, Stanford University, Stanford, CA, ProQuest Co., Ann Arbor, MI, pub. 99-95274, 196 pp., <http://wwwlib.umi.com/dissertations/preview/9995274>.

Porter, K.A. (2003). An overview of PEER's performance-based earthquake engineering methodology. *Proc. Ninth International Conference on Applications of Statistics and Probability in Civil Engineering (ICASP9) July 6-9, 2003, San Francisco, CA*. Civil Engineering Risk and Reliability Association (CERRA), <http://spot.colorado.edu/~porterka/>.

Porter, K.A. (2009a). Cracking an open safe: HAZUS vulnerability functions in terms of structure-independent spectral acceleration. *Earthquake Spectra* 25 (2), 361-378, <http://www.sparisk.com/pubs/Porter-2009-Safecrack-Casualty.pdf>.

Porter, K.A. (2009b). Cracking an open safe: more HAZUS vulnerability functions in terms of structure-independent spectral acceleration. *Earthquake Spectra* 25 (3), 607-618, <http://www.sparisk.com/pubs/Porter-2009-Safecrack-MDF.pdf>.

Porter, K.A. (2010). Cracking an open safe: uncertainty in HAZUS-based seismic vulnerability functions. *Earthquake Spectra*, 26 (3), 893-900 <http://www.sparisk.com/pubs/Porter-2010-Safecrack-COV.pdf>.

Porter, K.A. (2016a). Not safe enough: the case for resilient seismic design. *2016 SEAOC Convention, October 12-15, 2016, Maui HI*, <http://www.sparisk.com/pubs/Porter-2016-SEAOC-Resilience.pdf>.

Porter, K.A. (2016b). *An Earthquake Urban Search and Rescue Model Illustrated with a Hypothetical Mw 7.0 Earthquake on the Hayward Fault*. Structural Engineering and Structural Mechanics Report SESM 16-03, University of Colorado Boulder, <http://www.colorado.edu/ceae/node/1094/attachment>.

Porter, K.A. (2018). A new model of water-network resilience, with application to the HayWired scenario. *The HayWired Earthquake Scenario—Engineering Implications*: chap. N edited by S.T. Detweiler, and Wein, A.M.: U.S. Geological Survey Scientific Investigations Report 2017-5013-I-Q.

Porter, K.A., Beck, J.L., Seligson, H.A., Scawthorn, C.R., Tobin, L.T., and Boyd, T. (2002). *Improving Loss Estimation for Woodframe Buildings*. Consortium of Universities for Research in Earthquake Engineering, Richmond, CA, 136 pp., <http://resolver.caltech.edu/caltechEERL:2002.EERL-2002-01> (main report) and <http://resolver.caltech.edu/caltechEERL:2002.EERL-2002-02> (appendices) [retrieved November 14, 2018]

Porter, K.A., and Cobeen, K. (2012). Informing a retrofit ordinance: a soft-story case study. *Proc. 2012 Structures Congress*, Chicago IL, March 29-31, 2012.

Porter, K.A., Kennedy, R.P., and Bachman, R.E. (2007). Creating fragility functions for performance-based earthquake engineering. *Earthquake Spectra* 23 (2), p. 471-489

Porter, K.A., Scawthorn, C.R., and Beck J.L. (2006). Cost effectiveness of stronger woodframe buildings. *Earthquake Spectra* 22 (1), February 2006, 239-266, DOI:10.1193/1.2162567, <http://www.sparisk.com/pubs/Porter-2006-woodframe.pdf>.

Prager, F., Wei, D., and Rose, A. (2017). Total economic consequences of an influenza outbreak in the United States. *Risk Analysis* 37(1):4-19.

ProMatcher (2017). *Wheelchair Ramps Costs & Prices – ProMatcher Cost Report*. <http://wheelchair-ramps.promatcher.com/cost/>. [accessed December 6, 2017].

Quintiere, J.G. (1998). *Principles of Fire Behavior*. Albany, N.Y.: Delmar Publishers.

Ramseyer, C. and Holliday, L. (2014). City of Moore New Building Code for Tornado Resistance. Presentation to the Moore City Council, February 18, 2014. <https://www.cityofmoore.com/sites/default/files/main-site/City%20of%20Moore%20Code%20Adoption%20Feb%202014%20-%20Web%20reduced.pdf>. [accessed November 8, 2017].

Rashed, T. (2005). Geospatial Technologies, Vulnerability Assessment, and Sustainable Hazards Mitigation in Cities. In M. Campagna, editor, *GIS for Sustainable Development: Bringing Geographic Information Science into Practice towards Sustainability*, Taylor and Francis (CRC Press), New York: 287:309.

Rashed, T. and Weeks, J. (2003). Assessing vulnerability to earthquake hazards through spatial multicriteria analysis of urban areas. *International Journal of Geographic Information Science*, 17 (6): 549-576.

Ravetz, J. (2008). State of the stock—What do we know about existing buildings and their future prospects? *Energy Policy*, 36(12), 4462-4470.

Reed, N. (1986) Man's love of books almost kills him in quake. *Los Angeles Times*, July 14, 1986. <https://www.latimes.com/archives/la-xpm-1986-07-14-mn-19239-story.html> [retrieved March 25, 2019]

Reitherman, R. and Cobeen, K. (2003). *Design Documentation of Woodframe Project Index Buildings*, Publication W-29, Consortium of Universities for Research in Earthquake Engineering, Richmond, CA, 258 pp.

Resilient Organisations (2017). *Publications*. <http://www.resorgs.org.nz/Publications/books.html>. [accessed 30 July 2017].

Resurreccion, J.Z., and Santos, J.R. (2013). Uncertainty modeling of hurricane-based disruptions to interdependent economic and infrastructure systems. *Natural Hazards*, 69, 1497-1518.

Richardson, L.A., Champ, P.A., and Loomis, J.B. (2012). The hidden cost of wildfires: Economic valuation of health effects of wildfire smoke exposure in Southern California. *Journal of Forest Economics* 18(1):14-35.

Romero, N., Nozick, L.K., Dobson, I., Xu, N., and Jones, D. A. (2015). Seismic retrofit for electric power systems. *Earthquake Spectra* 31 (2): 1157-1176.

Rose, A. (2009). *Economic Resilience to Disasters: Community and Regional Resilience Institute (CARRI) Research Report 8*. Oakridge, TN: CARRI Institute.

Rose, A., and Liao, S. (2005). Modeling regional economic resilience to disasters: A computable general equilibrium analysis of water service disruptions, *Journal of Regional Science*, 45, 75-112.

Rose, A., and Miernyk W. (1989). Input–output analysis: the first fifty years. *Economic Systems Research*, 1, 229-272.

Rose, A., Oladosu, G. and Liao, S.Y. (2007a). Business interruption impacts of a terrorist attack on the electric power system of Los Angeles: customer resilience to a total blackout. *Risk Analysis* 27 (3): 513-531.

Rose, A., Porter, K., Dash, N., Bouabid, J., Huyck, C., Whitehead, J., Shaw, D., Eguchi, R., Taylor, C., and McLane, T. (2007b). Benefit-cost analysis of FEMA hazard mitigation grants. *Natural Hazards Review* 8 (4): 97-111.

Rose, A., Porter, K.A., Dash, N., Bouabid, J., Huyck, C., Whitehead, J.C., Shaw, D., Eguchi, R. T., Taylor, C.E., McLane, T.R., Tobin, L.T., Ganderton, P.T., Godschalk, D., Kiremidjian, A.S., Tierney, K., and West, C.T. (2007). Benefit-cost analysis of FEMA hazard mitigation grants. *Natural Hazards Review*, 8 (4), 97-111.

Rossman, L.A. (2000). *Epanet User Manual*. 200 p. Cincinnati: Water Supply and Water Resources Division, National Risk Management Research, Laboratory Environmental Protection Agency.

RSMeans (2015). *RSMeans Square Foot Costs 2016 37th Edition*, The Gordian Group, Greenville SC, 500 p.

RSMeans (2016). *Building Construction Costs with RSMeans Data*. Rockland, MA Gordian RSMeans Data.

RSMeans (n.d.). *How to Use the City Cost Indexes*. [https://www.rsmeansonline.com/References/CCI/2-Assemblies%20\(UniFormat\)/0-How%20To%20Use.pdf](https://www.rsmeansonline.com/References/CCI/2-Assemblies%20(UniFormat)/0-How%20To%20Use.pdf).

Sabelli, R., Mahin, S., and Chang, C. (2003). Seismic demands on steel braced frame buildings with buckling-restrained braces. *Engineering Structures*, 25 (5), 655-666.

San Francisco Board of Supervisors (2013). *Ordinance 66-13, Building Code – Mandatory Seismic Retrofit Program – Wood-Frame Buildings; Optional Evaluation Form Fee*. San Francisco, California, 5 p. <https://www.sfbos.org/ftp/uploadedfiles/bdsupvrs/ordinances13/o0066-13.pdf> [retrieved November 14, 2018]

## NATURAL HAZARD MITIGATION SAVES:

Santa Monica, California (2017). *Ordinance Number 2537, an Ordinance of the City Council of the City of Santa Monica Amending Articles IV and VIII of the Santa Monica Municipal Code by Updating Seismic Retrofit Standards and Tenant Protection Laws*. Santa Monica City Clerk, 62 p.

<https://www.smgov.net/uploadedFiles/Departments/PCD/Programs/Seismic-Retrofit/Ordinance%202537.pdf> [retrieved November 15, 2018]

Santato, S., Bender, S., and Schaller, M. (2013). *The European Floods Directive and Opportunities offered by Land Use Planning* (CSC Report 12). Climate Service Center, Germany, 75 p.

Santos, J.R. (2006). Inoperability input-output modeling of disruptions to interdependent economic systems. *Systems Engineering*, 9, 20-34.

Santos, J.R., and Haimes, Y.Y. (2004). Modeling the demand reduction input-output inoperability due to terrorism of interconnected infrastructures. *Risk Analysis*, 24, 1437-1451.

Santos, J.R., Barker, K., and Zelinke, P. (2008). Sequential decision-making in interdependent sectors with multiobjective inoperability decision trees. *Economic Systems Research*, 20, 29-56.

Santos, J.R., Haimes, Y.Y., and Lian (2007). A framework for linking cyber security metrics to the modeling of macroeconomic interdependencies. *Risk Analysis: An International Journal*, 27, 1283-1297.

(SBA) Small Business Administration (2012-2016). *SBA Disaster Loan Data FYs 2012 to 2016*, <https://www.sba.gov/loans-grants/see-what-sba-offers/sba-loan-programs/disaster-loans/disaster-loan-data> [accessed 4 September 2017].

Scawthorn, C. (2011). *Water Supply in Regards to Fire Following Earthquakes*: 173. Berkeley: Pacific Earthquake Engineering Research Center, College of Engineering, University of California, sponsored by the California Seismic Safety Commission, available at [http://www.seismic.ca.gov/pub/CSSC\\_2011-02\\_WaterSupply\\_PEER.pdf](http://www.seismic.ca.gov/pub/CSSC_2011-02_WaterSupply_PEER.pdf) with summary at [http://peer.berkeley.edu/publications/peer\\_reports/reports\\_2011/Fire%20Following%20Earthquake-online-view-layout-sm.pdf](http://peer.berkeley.edu/publications/peer_reports/reports_2011/Fire%20Following%20Earthquake-online-view-layout-sm.pdf).

Scawthorn, C. (2018). Fire following the HayWired scenario mainshock. *The HayWired earthquake scenario—Engineering Implications*: chap. P edited by S.T. Detweiler, and Wein, A.M. Washington: U.S. Geological Survey Scientific Investigations Report 2017–5013–I–Q.

Scawthorn, C., Ballantyne, D.B., and Blackburn, F. (2000). Emergency water supply needs lessons from recent disasters. *Water Supply* 18 (3): 69-81.

Scawthorn, C., Myerson, D., York, D., and Ling, E. (2017). Determining water distribution system pipe replacement given random defects – case study of San Francisco’s auxiliary water supply system. *Water System Seismic Conference, Joint conference of the American Water Works Association, Japan Water Works Association and the Chinese Taiwan Water Works Association. Tainan*.

Scawthorn, C.R. (2011). Fire following earthquake aspects of the Southern San Andreas Fault Mw 7.8 earthquake scenario. *Earthquake Spectra* 27 (2): 419-41.

Scawthorn, C.R., Cowell, A.D., and Borden, F. (1998). *Fire-Related Aspects of the Northridge Earthquake*. NIST-GCR-98-743, National Institute of Standards and Technology, Gaithersburg Maryland, 165 p.

Schlake, B., Barkan, C., & Edwards, J. (2011). Train delay and economic impact of in-service failures of railroad rolling stock. *Transportation Research Record: Journal of the Transportation Research Board*, (2261), 124-133.

Schoennagel, T., Balch, J. K., Brenkert-Smith, H., Dennison, P. E., Harvey, B. J., Krawchuk, M. A., Mietkiewicz, N., Morgan, P., Moritz, M. A., Rasker, R., Turner, M. G., and Whitlock, C. 2017. Adapt to more wildfire in western North American forests as climate changes. *Proceedings of the National Academy of Sciences (USA)*, 114 (18): 4582–4590.

Scott, J.H., Thompson, M.P., and Calkin, D.E. (2013). *A Wildfire Risk Assessment Framework for Land and Resource Management*. United States Department of Agriculture, Forest Service, Rocky Mountain Research Station, 83 p.

(Sea Grant) Sea Grant North Carolina and Duke Nicholas Institute for Environmental Policy Solutions (2017). *North Carolina's Ocean Economy A First Assessment and Transitioning to a Blue Economy*, Sea Grant North Carolina and Duke Nicholas Institute for Environmental Policy Solutions, 29 p.

[https://ncseagrant.ncsu.edu/ncseagrant\\_docs/products/2010s/NC\\_Ocean\\_Economy\\_White\\_Paper.pdf](https://ncseagrant.ncsu.edu/ncseagrant_docs/products/2010s/NC_Ocean_Economy_White_Paper.pdf)

Seabrook: Various materials on Seabrook website: <http://www.seabrooktx.gov/>.

Seligson, H.A., and Shoaf, K.I. (2003). Human impacts of earthquakes. *Earthquake Engineering Handbook*, W.F. Chen and C.R. Scawthorn, eds., Chapter 28, CRC Press, New York, NY.

Shafieezadeh, A., Onyewuchi, U.P., Begovic, M.M., and DesRoches, R. (2014). Age-dependent fragility models of utility wood poles in power distribution networks against extreme wind hazards. *IEEE Transactions on Power Delivery*, 29 (1), February 2014.

Shafran, A.P. (2008). Risk externalities and the problem of wildfire risk. *Journal of Urban Economics* 64(2):488-495

Shinozuka, M., Zhou, Y., Kim, S.H., Murachi, Y., Banerjee, S., Cho, S., & Chung, H. (2005). Socio-economic effect of seismic retrofit implemented on bridges in the Los Angeles highway network. *Final Report to the California Department of Transportation*.

Short, K.C., Finney, M.A., Scott, J.H., Gilbertson-Day, J.W., and Grenfell, I.C. (2016). *Spatial Dataset of Probabilistic Wildfire Risk Components for the Conterminous United States*, available at <https://doi.org/10.2737/RDS-2016-0034>. Edited by U.S. Forest Service. Fort Collins, CO.



Shreve, C.M. and Kellman, I. (2014). Does mitigation save? Reviewing cost-benefit analyses of disaster risk reduction, *International Journal of Disaster Risk Reduction*, 10, 213-235.

Shumuta, Y. (2004). Benefit-cost analysis for renewal planning of existing electric power equipment. *Modeling Spatial and Economic Impacts of Disasters*. Springer, p. 257-287

Simmons, K., Czajkowski, J., and Done, J. (2017). Economic Effectiveness of Implementing a Statewide Building Code: The Case of Florida.

Simmons, K.M., Czajkowski, J., and Done, J.M. (2018). Economic effectiveness of implementing a statewide building code: the case of Florida. *Land Economics* 94 (2), 155-174

Simmons, K.M., Kovacs, P., and Kopp, G.A. (2015). Tornado damage mitigation: Benefit–cost analysis of enhanced building codes in Oklahoma. *Weather, Climate, and Society* 7 (2), 169-178.

Somerville, P. (1998). Development of an improved representation of near-fault ground motions. *Proceedings of the SMIP98 Seminar on Utilization of Ground Motion, 15 Sep 1998, Oakland CA*

Southern Building Code Congress International (1946 et seq.). *Southern Standard Building Code*. Birmingham AL: Southern Building Code Congress International.

SPA Risk LLC (2009). *Enhancements In Hazus-Mh Fire Following Earthquake, Task 3: Updated Ignition Equation*. 74 pp. San Francisco: SPA Risk LLC, Berkeley CA. Principal Investigator C. Scawthorn. Prepared for PBS&J and the National Institute of Building Sciences.

SPA Risk LLC (2014). *Mobile Homes in Earthquakes, How to Protect Your Home and Family*. Denver, Colorado, 2 p., <http://www.sparisk.com/pubs/SPA-2014-Mobile-Homes-in-Earthquakes.pdf> [retrieved November 27, 2018]

Spence, R. (2004). Risk and regulation: can improved government action reduce the impacts of natural disasters? *Building Research and Information*, 32 (5), 391-402.

Spence, R.J.S., So, E., and Scawthorn, C. (2011). *Human Casualties In Earthquakes : Progress In Modelling And Mitigation*. New York: Springer.

Stanley Consultants (2011). *Facility Plan for Expansion of South Wastewater Treatment Plant, City of Iowa City, Iowa*. Stanley Consultants, Inc., Muscatine IA, 132 p. Whitehead, J.C., Haab, T.C., and Huang, J.C. (2000). Measuring recreation benefits of quality improvements with revealed and stated behavior data. *Resource and Energy Economics* 22, 339–354.

State of Florida (2002). *2001 Florida Codes 2001 – Building (2<sup>nd</sup> Edition)*. International Code Council, Falls Church, VA

## NATURAL HAZARD MITIGATION SAVES:

Steinbrugge, K.V. and Schrader, E.E. (1979). *Mobile Home Damage and Losses*. Santa Barbara Earthquake August 13, 1978. State of California Seismic Safety Commission, Sacramento, CA, 19 p.

Stone, B. (1999). Confusion about water heater straps. *Los Angeles Times*, May 30, 1999

Sutliff, K. (2011). *Memorandum-Quarterly Non-Toll Seismic Safety Retrofit Report*. Prepared for The State of California Department of Transportation. CTC Meeting March 23-24, 2011.

Suzuki, S., Manzello, S.L., Lage, M., and Laing, G. 2012. Firebrand generation data obtained from a full-scale structure burn. *Intl. J. Wildland Fire*, 21, 961-968.

Sveikauskas, L., Rowe, S., and Mildenerger, J.D. (2018). Measuring productivity growth in construction. *Monthly Labor Review*. January 2018. U.S. Bureau of Labor Statistics.

Sweet, W.V., Kopp, R.E., Weaver, C.P., Obeykera, J., Horton, R.M., Thieler, E.R., and Zervas, C. (2017). *Global and regional sea level rise scenarios for the United States*. Silver Spring, MD.

<https://repository.library.noaa.gov/view/noaa/14344>.

Tallahassee Community College (2019). *Mobile Home Tie-Down Program*.

<https://www.tcc.fl.edu/about/college/administrative-services/contracts-and-grants/mobile-home-tie-down-program/>

Tate, E., Muñoz, C., and Suchan, J. (2015). Uncertainty and Sensitivity Analysis of the HAZUS-MH Flood Model, *Natural Hazards Review*, 16 (3).

Taylor, G. (2019). *Solved! How Long a Water Heater Actually Lasts*. Bob Vila Media, <https://www.bobvila.com/articles/how-long-does-a-water-heater-last/> [retrieved February 6, 2019]

TCLEE (Ed.) (2005). *Fire Following Earthquake*. Reston: American Society of Civil Engineers, Technical Council for Lifeline Earthquake Engineering, Scawthorn et al (eds).

(TCLEE) Technical Council for Lifeline Earthquake Engineering (2005). *Fire Following Earthquake*. Reston: American Society of Civil Engineers.

Thomas, D.S.K., Phillips, B.D., Lovekamp, W.E., and Fothergill A., eds (2013). *Social Vulnerability to Disasters*. CRC Press: Boca Raton.

Thompson, M.P., Calkin, D.E., Finney, M.A., Ager, A.A., and Gilbertson-Day, J.W. (2011). Integrated national-scale assessment of wildfire risk to human and ecological values. *Stochastic Environmental Research and Risk Assessment*, 25 (6), 761-780.

Tie Down Engineering (2007). *Xi2 Engineered Tie Down System Installation Instructions for California for Ground & Concrete Systems HUD Wind Zone I, 15 PSF Wind Load Seismic 4*. Atlanta, Georgia, 8 p.

<https://www.mobilehomepartspro.com/images/categories/TieDowns/californiagroundsystem.pdf>

[retrieved December 13, 2018]

Tiedemann, K., and B.C. Hydro (2015). Modelling the value of reliability for residential electricity customers. *Proc., Software Engineering and Applications/831: Advances in Power and Energy Systems (SEA 2015)*, October 26 – 27, 2015, Marina del Rey, USA

Todd, D., Carino, N., Chung, R.M., Lew, H.S., Taylor, A.W., Walton, W.D., Cooper, J.D., and Nimis, R. (1994a). *1994 Northridge Earthquake Performance of Structures, Lifelines, and Fire Protection Systems*. NIST Special Publication 862. National Institute of Standards and Technology Gaithersburg, MD, 180 p.

Todd, D.R., Carino, N.J., Chung, R.M., Lew, H.S., Taylor, A.W., and Walton, W.D. (1994b). *1994 Northridge Earthquake: Performance of Structures, Lifelines and Fire Protection Systems*. NIST Interagency/Internal Report (NISTIR)-5396.

Tops Kitchen Cabinets (2014). When should you replace your kitchen cabinets? Blog. Pompano Beach, FL, <https://topscabinet.net/when-should-you-replace-your-kitchen-cabinets/> [retrieved February 6, 2019]

Trifunac, M.D., and Todorovska, M.I. (1998). The Northridge, California, earthquake of 1994: fire ignition by strong shaking. *Soil Dynamics and Earthquake Engineering* 17 165-175

(USACE) U.S. Army Corps of Engineers (2012). *Memorandum: Reissuance of the U.S. Army Corps of Engineers Environmental Operating Principles*. August 7, 2012.

[http://www.usace.army.mil/Portals/2/docs/Environmental/EAB/eop\\_coe\\_reissuedeop\\_07aug2012.pdf](http://www.usace.army.mil/Portals/2/docs/Environmental/EAB/eop_coe_reissuedeop_07aug2012.pdf).

(USACE) U.S. Army Corps of Engineers (2016). *Fiscal Year 2016 United States Army Annual Financial Report*.

[http://www.publications.usace.army.mil/Portals/76/Publications/Miscellaneous/FY2016\\_USACE-AFR\\_FINAL11-15v2.pdf](http://www.publications.usace.army.mil/Portals/76/Publications/Miscellaneous/FY2016_USACE-AFR_FINAL11-15v2.pdf).

(USCB) United States U.S. Census Bureau (2004). *Census 2000 Data*.

<https://www.census.gov//census2000/states/us.html>. [accessed 22 December 2017].

(USCB) United States U.S. Census Bureau (2010-2004). *American Community Survey (ACS) 5 Year Estimates*.

(USCB) United States U.S. Census Bureau (2010a). *Florida 2010 Census – Census Tract Reference Maps*.

[https://www.census.gov/geo/maps-data/maps/2010ref/st12\\_tract.html](https://www.census.gov/geo/maps-data/maps/2010ref/st12_tract.html).

(USCB) United States U.S. Census Bureau (2010b). *2010 Characteristics of New Housing*.

<https://www.census.gov/construction/chars/pdf/c25ann2010.pdf>. Page 389.

(USCB) United State U.S. Census Bureau (2012). *Manufacturing and International Trade Report: 2012*.

<https://www.census.gov/foreign-trade/Press-Release/MITR/2012/index.html>. [accessed December 6, 2017].

## NATURAL HAZARD MITIGATION SAVES:

(USCB) United States U.S. Census Bureau (2017). *Population and Housing Unit Estimates*.

<https://www.census.gov/programs-surveys/popest/data/tables.All.html>.

U.S. Army Corps of Engineers (2005). *Flood Proofing – Techniques, Programs, and References*. Washington, DC, 32 p.

U.S. Census Bureau (2013). American Housing Survey 2013 – All Housing Units

[https://factfinder.census.gov/faces/tableservices/jsf/pages/productview.xhtml?pid=AHS\\_2013\\_C02AH&prodType=table](https://factfinder.census.gov/faces/tableservices/jsf/pages/productview.xhtml?pid=AHS_2013_C02AH&prodType=table) [retrieved January 19, 2019]

U.S. Census Bureau (2017-KP1). *American Housing Survey 2017 National - General Housing Data - All Occupied Units*. <https://www.census.gov/programs-surveys/ahs/data/interactive/ahstablecreator.html#> [retrieved December 2, 2018]

U.S. Census Bureau (2018). 2018 Census U.S. Gazetteer files. *U.S. Gazetteer Files*.

[https://www2.census.gov/geo/docs/maps-data/data/gazetteer/2018\\_Gazetteer/2018\\_Gaz\\_tracts\\_national.zip](https://www2.census.gov/geo/docs/maps-data/data/gazetteer/2018_Gazetteer/2018_Gaz_tracts_national.zip) [retrieved Oct 19, 2018]

U.S. Census Bureau (2018). *Population Division Annual Estimates of the Resident Population for Incorporated Places of 50,000 or More, Ranked by July 1, 2017 Population: April 1, 2010 to July 1, 2017*.

U.S. Census Bureau (2018-KP2). *American Housing Survey Table Creator*.

[https://www.census.gov/programs-surveys/ahs/data/interactive/ahstablecreator.html#?s\\_areas=a00000&s\\_year=n2017&s\\_tableName=Table1&s\\_byGroup1=a1&s\\_byGroup2=a1&s\\_filterGroup1=t1&s\\_filterGroup2=g1&s\\_show=S](https://www.census.gov/programs-surveys/ahs/data/interactive/ahstablecreator.html#?s_areas=a00000&s_year=n2017&s_tableName=Table1&s_byGroup1=a1&s_byGroup2=a1&s_filterGroup1=t1&s_filterGroup2=g1&s_show=S) [retrieved December 12, 2018]

U.S. Department of Energy (2011) *Buildings Energy Data Book*. Buildings Technologies Program Energy Efficiency and Renewable Energy U.S. Department of Energy by D&R International, Ltd. under contract to Pacific Northwest National Laboratory. 286 p.

U.S. Geological Survey (2005). *Putting Down Roots in Earthquake Country*. General Information Product 15. 32 p. <https://pubs.usgs.gov/gip/2005/15/#stepone> [retrieved December 15, 2018]

U.S. Geological Survey (2012). Conterminous US 0.2 s and 1.0 s risk-targeted MCE (MCER) ground motions (0.01° gridded data, 24.6°-50° N, 125°65° W), U.S. Seismic Design Maps. *Seismic Design Data Sets*. [ftp://hazards.cr.usgs.gov/web/earthquake-designmaps/datasets/geo/2012\\_IBC-US\\_Ss\\_S1-0p01.txt](ftp://hazards.cr.usgs.gov/web/earthquake-designmaps/datasets/geo/2012_IBC-US_Ss_S1-0p01.txt) [retrieved Oct 19, 2018]

(USGS) United States U.S. Geological Survey (2017). *National Elevation Dataset*. Retrieved May 2017 from <https://lta.cr.usgs.gov/NED>.

## NATURAL HAZARD MITIGATION SAVES:

United States Army Corps of Engineers (2013). *Principles and Guidelines for Federal Investments in Water Resources, Federal Support Toolbox, National Action Plan: Integrated Water Resources Management (IWRM) Actions*. Presentation of Olsen, R. [https://acwi.gov/climate\\_wkg/minutes/acwi-olsen-4-17-13.pdf](https://acwi.gov/climate_wkg/minutes/acwi-olsen-4-17-13.pdf). [accessed November 8, 2017].

United States Department of Commerce (1997). *Regional Multipliers: A User Handbook for the Regional Input-Output Modeling System*, Washington, DC: U.S. Government Printing Office.

US Geological Survey (2018). *National Hydrography Dataset*. <https://nhd.usgs.gov/>. [accessed October 24, 2018].

USFA (2018). Residential and Nonresidential Building Fire and Fire Loss Estimates by Property Use and Cause (2003-2015). U.S. Fire Administration, [https://www.usfa.fema.gov/data/statistics/order\\_download\\_data.html#download](https://www.usfa.fema.gov/data/statistics/order_download_data.html#download), accessed 27 April 2018

van de Lindt, J.W., Abell, G.T., Bahmani, P., Gershfeld, M., Shao, X., Pang, W., Symans, M.D., Ziaei, E., Pryor, S.E., Rammer, D. and Tian, J. (2013). Full-Scale Dynamic Testing of Soft-Story Retrofitted and Un-Retrofitted Woodframe Buildings. *Proceedings, Structural Engineers Association of California Convention, September 18-21, 2013, San Diego, California*; p. 219-228, [https://www.fpl.fs.fed.us/documnts/pdf2013/fpl\\_2013\\_lindt003.pdf](https://www.fpl.fs.fed.us/documnts/pdf2013/fpl_2013_lindt003.pdf) [retrieved November 15, 2018]

Varney, T.K. (2016). 2016's top business risks: business interruption remains top spot fourth year in a row. *Supply and Demand Chain Executive: Risk Management*. <http://www.sdexec.com/article/12165269/2016s-top-business-risks-business-interruption-remains-top-spot-fourth-year-in-a-row>. [accessed 31 Jul 2017].

Vickery, P.J. and Skerlj, P.F. (2005). Hurricane gust factors revisited. *Journal of Structural Engineering*, 131 (5), 825-832.

Vukazich, S.M., Selvaduray, G., and Tran, J. (2006). Conducting a soft first-story multifamily dwelling survey: an example using Santa Clara County, California. *Earthquake Spectra* 22 (4), 1063-1079.

Wald, D.J., Quitorano, V., Heaton, T., and Kanamori, H. (1999). Relationships between peak ground acceleration, peak ground velocity, and modified Mercalli intensity in California. *Earthquake Spectra* 15 (3): 557-564.

Watkins, T. (n.d.). *An Introduction to Cost Benefit Analysis*. <http://www.sjsu.edu/faculty/watkins/cba.htm>. [accessed December 6, 2017].

Webb G., Tierney K., and Dahlhamer J. (2000). Business and disasters: empirical patterns and unanswered questions. *Natural Hazards Review*, 1, 83-90.

## NATURAL HAZARD MITIGATION SAVES:

Weber, S.F. (1985). Cost impact of the NEHRP Recommended Provisions on the design and construction of buildings. *FEMA 84, Societal Implications: Selected Readings*. Building Seismic Safety Council for the Federal Emergency Management Agency, Washington, D.C.: 15-33

Webster, P. J., Holland, G. J., Curry, J. A., and Chang, H.-R. (2005). Changes in tropical cyclone number, duration, and intensity in a warming environment. *Science*. 309: 1844-1846.

Werner, S.D., Cho, S., Taylor, C.E., Lavoie, J.P., Huyck, C.K., Chung, H., and Eguchi, R.T. (2006). *Technical Manual: REDARS™ 2 Methodology and Software for Seismic Risk Analysis of Highway Systems*. Report MCEER-06-SP08, Buffalo NY: Multidisciplinary Center for Earthquake Engineering Research.

West Hollywood (2017). *Ordinance Number 17-1004, An Ordinance of the City of West Hollywood Establishing Seismic Strengthening Requirements for Two Categories of Existing Buildings in the City and Amending the West Hollywood Municipal Code*. West Hollywood City Clerk, 16 p.

<https://www.weho.org/home/showdocument?id=31443> [retrieved November 19, 2018]

White House (2016). *Standards and Finance to Support Community Resilience*, Washington, DC, 29 p.

Wills, C.J. and Clahan, K.B. (2006). Developing a map of geologically defined site-conditions categories for California. *Bulletin of the Seismological Society of America*, 96 (4A), 1483-1501

Wills, C.J., Gutierrez, C.I., Perez, F.G., and Branum, D.M. (2015). A next generation VS30 map for California based on geology and topography. *Bulletin of the Seismological Society of America* 105 (6) 3083–3091

World Bank (2017). *Population Growth (Annual %)*.

[https://data.worldbank.org/indicator/SP.POP.GROW?locations=US&name\\_desc=true](https://data.worldbank.org/indicator/SP.POP.GROW?locations=US&name_desc=true). [accessed 6 December 2017].

Wright, R., Mitigation Directorate, & United States House of Representatives (2014). *A Review of the National Earthquake Hazards Reduction Program (NEHRP)*. [https://dam-production.s3-us-gov-west-1.amazonaws.com/uploads/1408038637998-3354eb12e21447bc19f59d80a75a82fa/7-29-14%20-%20NEHRP\\_508.pdf](https://dam-production.s3-us-gov-west-1.amazonaws.com/uploads/1408038637998-3354eb12e21447bc19f59d80a75a82fa/7-29-14%20-%20NEHRP_508.pdf) [accessed 19 October 2017].

Zhuang, J., Liang, Z., Lin, T., and De Guzman, F. (2007). *Theory and Practice in the Choice of Social Discount Rate for Cost-Benefit Analysis: a Survey*.

## Appendix A. Glossary and List of Acronyms

### A.1. GLOSSARY

<b>Benefit-cost ratio</b>	The ratio of the benefits of a project or proposal, expressed in monetary terms, relative to its costs, also expressed in monetary terms. Calculated as the discounted value of incremental benefits divided by the discounted value of incremental costs.
<b>Defensible space</b>	An area either natural or manmade, where material capable of allowing a fire to spread unchecked has been treated, cleared or modified to slow the rate and intensity of an advancing wildfire and to create an area for fire suppression operations to occur.
<b>Fragility</b>	The relationship between environmental excitation and the occurrence probability of some undesirable outcome, such as the collapse of a building.
<b>Fragility function</b>	A curve in x-y space where x measures environmental excitation, y measures the occurrence probability of some undesirable outcome, and the curve represents the performance of a specified asset class.
<b>Hazard</b>	Here, the mathematical relationship between a (usually scalar) measure of environmental excitation (such as wind speed) and the frequency with which that level of excitation is exceeded, e.g., in times per year.
<b>Hazard curve</b>	An x-y chart where x measures environmental excitation (e.g., wind speed) and y measures exceedance frequency (e.g., times per year). A curve in that space represents hazard for a given site. It is generally higher on the left and lower on the right.
<b>Ignition-resistant construction and materials</b>	Ignition-resistant building materials resist ignition or sustained flaming combustion sufficiently so as to reduce losses from wildland-urban interface conflagrations under worst-case weather and fuel conditions with wildfire exposure of burning embers and small flames, as prescribed in Section 503 of the 2015 IWUIC. A schedule of additional requirements for construction in wildland-urban interface areas are based on extreme (Class 1), high (Class 2), and moderate (Class 3) fire hazard.
<b>Interface</b>	Areas with $\geq 6.18$ houses per $\text{km}^2$ and $< 50$ percent cover of vegetation located $< 2.4$ km of an area $\geq 5 \text{ km}^2$ in size that is $\geq 75$ percent vegetated.

## NATURAL HAZARD MITIGATION SAVES:

<b>Intermix</b>	Areas with $\geq 6.18$ houses per $\text{km}^2$ and $\geq 50$ percent cover of wildland vegetation.
<b>Peril</b>	A cause of damage. In this report, peril refers to hurricanes, floods, earthquakes, and fire and wildland-urban interface. The word peril is sometimes used instead of hazard, because hazard can mean the probabilistic relationship between the degree of environmental excitation caused by a peril (such as wind speed, where the peril is hurricane) and the frequency with which that degree occurs.
<b>Risk curve</b>	An x-y chart where x measures loss (e.g., deaths) and y measures exceedance frequency (e.g., times per year). A curve in that space represents risk for a given asset. It is generally higher on the left and lower on the right.
<b>Risk</b>	Here, the mathematical relationship between a (usually scalar) measure of loss (such as number of people killed) and the frequency with which that level of loss is exceeded, e.g., in times per year.
<b>Vulnerability</b>	The relationship between a scalar measure of environmental excitation (e.g., momentum flux in the case of flooding in a velocity zone—a stream or seashore) and a scalar degree of loss (e.g., repair cost as a fraction of replacement cost, new).
<b>Vulnerability function</b>	A curve in x-y space where x measures environmental excitation, y measures the expected value of loss, and the curve represents the performance of a specified asset class, such as a woodframe single-family dwelling built after 2012.
<b>Vulnerable (socially)</b>	Vulnerability is also used throughout the Interim Study to represent socially vulnerable populations. Social vulnerability refers to the characteristics of people and groups that influence their ability to anticipate, cope with, resist and recover from the impact of disasters. These characteristics may be social, economic, physical, or environmental and are influenced by the structural conditions within society that affect the ability to garner resources related to hazards and disasters.
<b>Wildland</b>	An area in which development is essentially nonexistent, except for roads, railroads, power lines, and similar facilities.
<b>Wildland-urban interface</b>	The geographical area where structures and other human development meet or intermingle with wildland or vegetative fuels.



## **A.2. LIST OF ACRONYMS**

AAL	Average Annualized Loss
ADA	Americans with Disabilities Act of 1990
AIA	American Institute of Architects
AIS	Abbreviated Injury Scale
ALE	Additional Living Expenses
ASCE	American Society of Civil Engineers
ASD	Allowable Stress Design
ASFPM	Association of State Floodplain Managers
BCA	Benefit-Cost Analysis
BCEGS	Building Code Effectiveness Grading Schedule
BCP	Business Continuity Planning
BCR	Benefit-Cost Ratio
BEA	Bureau of Economic Analysis
BFE	Base Flood Elevation
BI	Business Interruption
BOCA	Building Officials and Code Administrators International, Inc.
BOMA	Building Owners and Managers Association
BP	Burn Probability
BSSC	Building Seismic Safety Council
Caltech	California Institute of Technology
C&C	Components and Cladding
CCI	City Cost Index
CDBG	Community Development Block Grant
CEA	California Earthquake Authority
CEUS	Central and Eastern United States
CFIRE	Council on Finance, Insurance and Real Estate
CGE	Computable General Equilibrium
CPI	Consumer Price Index
CRS	Community Rating System
CUREE	Consortium of Universities for Research in Earthquake Engineering
DDF	Depth Damage Function
DFE	Design Flood Elevation
DIIM	Dynamic Inoperability IO Model
DOE	U.S. Department of Energy
DOT	U.S. Department of Transportation
DR	Disaster Recovery
ERM	Enterprise Risk Management
EAL	Expected Annualized Loss

## NATURAL HAZARD MITIGATION SAVES:

EDA	U.S. Economic Development Administration
EIA	Energy Information Administration
ETS	Engineered tie-down system
FEMA	Federal Emergency Management Agency
FIL	Fire Intensity Level
FIRM	Flood Insurance Rate Map
FIS	Flood Insurance Studies
FLI	Fireline Intensity
FMA	Flood Mitigation Assistance
GBS	General Building Stock
GDP	Gross Domestic Product
GEM	Global Earthquake Model
GIC	Glacier and Ice Cap Mass Balance
GIS	Geographic Information System
GMSL	Global Mean Sea Level
GASL	Global Average Sea Level
GSL	Global Sea Level
HFIAA	Homeowner Flood Insurance Affordability Act
HMA	Hazard Mitigation Assistance
HMGP	Hazard Mitigation Grant Program
HUD	U.S. Department of Housing and Urban Development
IAWF	International Association of Wildland Fire
IBC	<i>International Building Code</i>
IBHS	Insurance Institute for Business and Home Safety
ICBO	International Conference of Building Officials
ICC	International Code Council
IEBC	<i>International Existing Building Code</i>
IEMax	Incrementally Efficient Maximum
IFM	Integrated Flood Mitigation
IIM	Inoperability IO Model
IO	Input-Output
IRC	<i>International Residential Code</i>
IRR	Internal Rate of Return
ISO	Insurance Services Office
ISR	Inventory-to-Sales Ratios
IWUIC	<i>International Wildland-Urban Interface Code</i>
LSL	Local Sea Level
MCE	Maximum Considered Earthquake
MCER	Maximum Considered Earthquake, Risk Targeted
MMC	Multihazard Mitigation Council

## NATURAL HAZARD MITIGATION SAVES:

MOMs	Maximum-of-Maximums
MRI	Mean Recurrence Interval
NAICS	North American Industry Classification System
NBC	<i>National Building Code</i>
NEHRP	National Earthquake Hazard Reduction Program
NFIP	National Flood Insurance Program
NFPA	National Fire Protection Association
NHC	National Hurricane Center
NIBS	National Institute of Building Sciences
NIST	National Institute of Standards and Technology
NOAA	National Oceanic and Atmospheric Administration
NSHMP	National Seismic Hazard Mapping Program
NWS	National Weather Service
O&P	Overhead and Profit
OMB	Office of Management and Budget
OSB	Oriented Strand Board
OSM	OpenStreetMap
PA	Public Assistance
PDM	Pre-Disaster Mitigation
PPP	Purchasing Power Parity
PTSD	Post Traumatic Stress Disorder
RCP	Representative Concentration Pathways
ROI	Return on Investment
SBC	<i>Standard Building Code</i>
SLR	Sea Level Rise
SBA	Small Business Administration
SBCCI	Southern Building Code Congress International
SEAOC	Structural Engineers Association of California
SEAONC	Structural Engineers Association of Northern California
SEAOSC	Structural Engineers Association of Southern California
SEAOSD	Structural Engineers Association of San Diego
SEC	U.S. Securities and Exchange Commission
SEI	Structural Engineering Institute
SFHA	Special Flood Hazard Area
SRTP	Social Rate of Time Preference
SSHWS	Saffir-Simpson Hurricane Wind Scale
TIPS	Treasury Inflation-Protected Securities
UBC	<i>Uniform Building Code</i>
UDF	User-Defined Facility
URM	Unreinforced Masonry

## NATURAL HAZARD MITIGATION SAVES:

USACE	U.S. Army Corps of Engineers
USAR	Urban search and rescue
USCB	U.S. Census Bureau
USFS	U.S. Forest Service
USGS	U.S. Geological Survey
VSFA	Value of a Statistical Fatality Avoided
WHP	Wildfire Hazard Potential
WUI	Wildland-Urban Interface
WUS	Western United States

## Appendix B. Databases

### B.1. BUILDING-RELATED GRANTS

Program area Y (EDW SAP Data Tools HMGP from NEMIS; FMA & PDM from eGrant)

Project title Y

Project status

Project category, if agency categorizes projects (project type)

Declaration number (when applicable)

Declaration title

Date of loss

Date project approved or awarded (FEMA is still awarding grants 10 years after Katrina)

Date mitigation completed (Y, but sometimes years after the work completed)

Primary peril (flood, wind, earthquake, fire, ...) (Y, but can be dirty)

Peril 2 (if any)

Location: census block or address to nearest say 10 or 100, or latitude and longitude (Y, can be dirty)

Elevation of 1st floor above grade (feet, at main entrance), pre-disaster (iffy; look in BCA)

Original year built (paper files)

Building total floor area (sq ft) (paper files)

Use of the building (occupancy); For businesses: NAICS or SIC (may be able to extrapolate from project type--public or private)

Number of stories above grade (iffy)

Number of basements (Y/N)

Replacement cost (new) of building before disaster (paper files)

Replacement cost (new) of building after disaster and repairs/upgrades (paper files)

Number of employees or residents (no, but nonresidential may be in BCA or paper files)

Drawings or description or Xactimate file (no, but paper files)

Describe any improvement (or just return to pre-disaster condition?) (project description)

FEMA model building type (or wall material) (paper files)

In the case of DR: total verified loss (\$) (PA)

Total project cost (\$ cost of mitigation or repair) (not to the level of individual buildings; paper)

Grant amount (\$) (same)

Loss verification report if any (PA not on mitigation side)

## B.2. DATA.GOV DATABASE OF HMGP GRANTS

Table A-1: Fields from HMGP grants database.

Field name	Sample
Region	8
State	Utah
disasterNumber	820
declarationDate	1989-01-31T00:00:00 +00:00
incidentType	Flood
disasterTitle	DIKE FAILURE & FLASH FLOODING
projectNumber	2
projectType	600.1: Warning Systems (as a Component of a Planned, Adopted, and Exercised Risk Reduction Plan)
projectTitle	FLOOD DETECTION INSTRUMENTS
projectDescription	INSTALL INSTRUMENTS BASED ON ASSESSMENT OF STRATEGIC LOCATIONS WHERE FLOODING NORMALLY OCCURS TO RECORD WATER AND RIVERFALL LEVELS. INSTRUMENTS TO BE DIRECT-TRANSMITTING TO EMERGENCY OFFICE FOR WARNINGS AND EVACUATION.
projectCounties	WASHINGTON
status	Closed
subgrantee	ST. GEORGE
subgranteeFIPSCode	5365330
projectAmount	80000
costSharePercentage	38
hash	55e80c336c8590edb3c3309d2a61ac90
lastRefresh	2014-11-20T15:16:39 +00:00

## B.3. PA DATA AVAILABILITY

When IBM (2016) documented the design of the PA data repository it designed for FEMA, it described several so-called *star schemas*: descriptions of sets of database tables. At the center of each star was a table of facts containing the information the project team cared about, such as a list of PA applicants, each with an associated disaster ID and location ID. Attached to the center of the star were tables listing the allowable values of one field, such as a list of allowable applicant IDs. Each table has a table name and a set of field names. Table A-2 maps the PA data to the 2017 *Interim Report* study data. In the column

## NATURAL HAZARD MITIGATION SAVES:

labeled "PA source," entries are formatted as table.field, where table refers to the table name in the PA database and field refers to the field name in the PA table.

**Table A-2:** Mapping PA data to the 2017 Interim Report study data.

Field	PA source	Comment
Program area	"PA"	
Project title	PA_PROJECT_SITE_DIMENSION S.project_location_desc	
Project status		
Project category, if agency categorizes projects (project type)		
Declaration number (when applicable)	PA_CASE_MGMT_PRJTN_FACTS .disaster_id	
Declaration title		
Date of loss		
Date project approved or awarded		
Date mitigation completed		
Primary peril (flood, wind, earthquake, fire, ...)		
Peril 2 (if any)		
Location: census block or address to nearest say 10 or 100, or latitude and longitude	PA_PROJECT_FACTS.LATITUDE & PA_PROJECT_FACTS.LONGITU DE	Separate into two fields
Elevation of 1st floor above grade (feet, at main entrance), pre-disaster		
Original year built		
Building total floor area (sq ft)		
Use of the building (occupancy); For businesses: NAICS or SIC		
Number of stories above grade		
Number of basements		
Replacement cost (new) of building before disaster		
Replacement cost (new) of building after disaster and repairs/upgrades		
Number of employees or residents		
Drawings or description or Xactimate file		

## NATURAL HAZARD MITIGATION SAVES:

Field	PA source	Comment
Project description (describe any improvement or just return to pre-disaster condition?)	PA_PROJECT_SITE_DIMENSIONS.SCOPE_OF_WORK	
FEMA model building type (or wall material)		
In the case of DR: total verified loss (\$)		
Total project cost (\$ cost of mitigation or repair)	PA_PROJECT_FACTS.PROJECT_AMOUNT	
Grant amount (\$)	PA_PROJECT_FACTS.FEDERAL_SHARE_OBLIGATED	
Loss verification report if any		

### B.4. EDA

The EDA electronic data referenced in this study date back to 2000. Fewer than 1,000 records address disaster. EDA provided the project team with just the disaster-related data, flagged based on appropriation descriptions (floods, hurricanes, etc.). The data reflect between 30 and 50 grants per year, varying between \$100,000 and \$2,000,000 in EDA funding. The grants went to nonprofits and public-sector organizations, and deal with sewer lines, road repairs, and general construction (public works).



## Appendix C. City of Moore Wind Code Enhancements

Quoted from the City of Moore, Oklahoma (2014b):

The following additions are hereby included in the dwelling code for the purposes of establishing minimum regulations governing residential construction for high wind resistance:

1. Roof sheathing (OSB or plywood) shall be nailed with 8d ring shank (0.131" × 2.5") or 10d (0.148" × 3") nails on 4" on center along the edges and 6" on center in the field. Dimensional lumber decking is not allowed.
2. Maximum spacing for roof framing shall be 16 inches on center. Minimum nominal sheathing panel size shall be 7/16. Minimum wood structural panel span rating shall be 24/16.
3. Connections for roof framing shall be designed for both compression and tension, and may include nail plates or steel connection plates. Connections for roof framing shall include connections on rafters, web members, purlins, kickers, bracing connections, and the connections to interior brace wall top plates or ceiling joists.
4. Gable end walls shall be tied to the structure, and may include steel connection plates or straps. The connections shall be made at the top and bottom of the gable end wall.
5. Structural sheathing panel (OSB or plywood) shall be required for gable end walls.
6. Hurricane clip or framing anchor shall be required on all rafter to wall connections.
7. The upper and lower story wall sheathing shall be nailed to the common rim board.
8. All walls shall be continuously sheathed with structural sheathing (OSB or plywood) using the CS-WSP method. Garage doors shall be framed using the sheathed portal frame method CS-PF. No form of intermittent bracing shall be allowed on an outer wall. Intermittent bracing may only be used for interior braced wall lines.
9. Nailing of wall sheathing (OSB or plywood) shall be increased to 8d ring shank (0.131" × 2.5") or 10d (0.148" × 3") nails on 4" on center along the edges and 6" on center in the field.
10. Structural wood sheathing shall be extended to lap the sill plate and nailed to the sill plate using a 4" on center along the edges. Structural wood sheathing shall be nailed to rim board if present with 8d ring shank (0.131 × 2.5") or 10d (0.148" × 3") nails on 4" on center along both the top and bottom edges of the rim board.
11. Garage doors shall be rated to 135 mph wind or above.
12. Exterior wall studs shall be 16" on center.

## Appendix D. Which PA Grant Years to Include

PA grants changed substantially after Hurricane Katrina struck in 2005. During the course of the study, the project team realized that those changes could influence the project objectives and affect the analysis. At least three options presented themselves, summarized in Table A-3. In light of their advantages and disadvantages, the project team selected option B.

**Table A-3:** Options for how to deal with changes in PA grants after 2005.

Option	Advantages	Disadvantages
A. Estimate BCR since 1993	Consistent with the <i>2005 Mitigation Saves</i> study and with proposal	Data-quality issues; less useful to readers
B. Estimate BCR from new mitigation	Much more useful to readers; better data quality	Less consistent with proposal
C. Do both	Advantages of both A and B	Inconsistent data and more work, without providing a compelling benefit to the reader

## Appendix E. Innovations Since the 2005 Mitigation Saves Study

**Inventory of U.S. building stock.** The project team used a 2008 building-stock inventory extracted from Hazus, but updated to 2016, that considered population growth (from Census Bureau data) and construction-cost inflation (from RSMeans). The *2005 Mitigation Saves* study had no such inventory.

**Seismic vulnerability for buildings designed to exceed I-Code requirements.** The project team created new vulnerability functions for repair costs, casualties, and loss of function (dollars, deaths, and downtime) for the entire U.S. building stock using the Cracking an Open Safe method (Porter 2009b). The *2005 Mitigation Saves* study did not consider designing to exceed I-Code requirements. The net effect of adding this consideration is to provide support for a new, practical, low-cost mitigation option.

**Seismic impairment of buildings designed to exceed I-Code requirements.** The project team evaluated earthquake-induced building impairment (collapse, red-tag, and yellow-tag) using two seismic fragility functions developed for the USGS (Porter 2016). These rely solely on three authoritative sources: (1) Luco et al.'s fragility model (2007) underlying ASCE 7-10  $MCE_R$  map, (2) FEMA P-695 (Federal Emergency Management Agency 2009) best estimate of the collapse probability of new, code-compliant buildings at  $MCE$  shaking, and (3) observations of the relative number of collapsed, red-tagged, and yellow-tagged buildings in the 1989 Loma Prieta, 1994 Northridge, and 2014 South Napa Earthquakes. The model was published in a leading scholarly journal (*Earthquake Spectra*) and extensively peer reviewed for the USGS, both by USGS scientists and by respected members of the Structural Engineers Association of Northern California (SEAONC). It was presented to hundreds of members of SEAONC, Structural Engineers Association of Southern California (SEAOSC), Structural Engineers Association of San Diego (SEAOSD), and Structural Engineers Association of California (SEAOC), as well as faculty and graduate students of several leading universities. The *2005 Mitigation Saves* study did not consider impairment, red-tagging or yellow-tagging. The net effect of this consideration is a more robust depiction of risk because it includes this more-tangible performance metric and support for a new, practical, low-cost mitigation option.

**Sea level rise.** Weather-related losses in the *2017 Interim Report* accounted for LSL rise. The *2005 Mitigation Saves* study did not consider changing sea levels. The net effect of the addition is a more accurate picture of mitigation savings from flood mitigation.

**Mitigation investments by HUD and EDA.** The project team expanded the scope of federal mitigation investments to include grants from programs outside HMGP, PDMA, and Project Impact. The *2005 Mitigation Saves* study did not include these. The net effect of the expanded scope is a richer depiction of the benefit of public-sector mitigation investment.

**Mental-health disaster impacts.** The project team accounted for the psychological trauma that disasters produce with a new methodology. The *2005 Mitigation Saves* study did not address mental health. The net effect is a richer depiction of disaster losses, more consistent with President Clinton's 1994 Executive Order

## NATURAL HAZARD MITIGATION SAVES:

to consider all types of benefits, tangible and intangible, from infrastructure investment. This addition raises BCRs and makes them more accurate.

**Mitigation synergies.** Few mitigation projects focus solely on one type of peril. Even when they do, the potential exists for externalities or spillovers. This project offers a framework to quantify synergies between mitigation strategies, such as between building design to exceed I-Code requirements, structural and nonstructural retrofit of existing buildings, and BCP and DR. An organization that engages in enterprise risk management (ERM) using all three strategies is likely to be more resilient than one that engages in only one or two. Its risk of ruin seems likely to be more reduced by such a comprehensive ERM approach than the sum of their individual effects would indicate.

## Appendix F. Sea Level Rise

To estimate the benefits of coastal flood mitigation, one must quantify LSL rise. The analysis requires baseline, lower-bound, and upper-bound values of LSL rise over time to estimate BCRs and to test sensitivity to uncertainty. The project team considered the advantages and disadvantages of three reasonable options:

1. Kopp (2014) provides analysis and a spreadsheet estimating LSL rise at various coastal locations by decade under each of three emissions pathways.
2. National Oceanic and Atmospheric Administration (2017a) lays out GMSL rise under each of 6 scenarios (labeled low, intermediate low, through extreme). National Oceanic and Atmospheric Administration (2017a) provides GMSL data on a 1-degree grid.
3. A combination of the two.

### Sea Level Rise Option 1: Kopp (2014)

Advantages:

1. Provides best estimates of LSL by location and decade under each of several emissions pathways.
2. Nobody knows what emissions pathway will turn out to be closest to the truth, but it is straightforward to condition on them, e.g., to say “Our baseline BCRs assume RCP6. Our lower-bound BCRs assume RCP8.5. Our upper-bound BCRs assume RCP 2.6.” One can call this advantage “clear probabilistic conditioning.”
3. Authoritative.

Disadvantages:

1. Not the newest, latest, greatest technique.
2. Not aligned with Union of Concerned Scientists.
3. Spatial data requires difficult spatial interpolation.

### Sea Level Rise Option 2: National Oceanic and Atmospheric Administration (2017a)

Advantages:

1. Best estimates of GMSL by 1-degree grid cell and decade.
2. Practical to implement.
3. Latest, greatest.
4. Aligned with Union of Concerned Scientists.
5. Authoritative.

Disadvantages:

1. Scenario labels (low, moderate-low, etc.) are misleading. They imply, for example, that moderate is some sort of best estimate of future GMSL. Closer inspection suggests however that it is nothing of the kind—not some sort of probabilistic mean, but rather it is labeled moderate only because it is an intermediate value in the range Kopp (2014) considered valid.
2. BCA must attempt to provide best-estimate values, so disadvantage 1 makes the use of the National Oceanic and Atmospheric Administration (2017a) option largely useless unless one can tie its scenarios back to clear probabilistic conditioning.
3. Scenario selection guidance in Section 6.1 is of little help for BCA.

### Sea Level Rise Option 3: Combine Kopp (2014) and National Oceanic and Atmospheric Administration (2017a)

Description: select the National Oceanic and Atmospheric Administration (2017a) scenarios that most closely resemble the project team's preferred Kopp (2014) baseline, lower-bound, and upper-bound emissions pathways, namely:

- Baseline = mean outcomes of RCP6.0 (virtually identical to RCP4.5). Closest to intermediate-low.
- Lower bound = high exceedance probability under RCP2.6. Closest to low.
- Upper bound = low exceedance probability under RCP8.5. Closest to intermediate-high.

Advantages:

1. Practical data set: best estimates of GMSL by 1-degree grid cell and decade.
2. Latest, greatest.
3. Aligned with Union of Concerned Scientists.
4. Authoritative.
5. Clear probabilistic conditioning.
6. Baseline errs on conservative side, a key requirement of the project team in the Interim Study.

Disadvantages:

1. None are obvious.

With the advice of the oversight committee and FEMA, the project team selected option 3, combine Kopp (2014) and National Oceanic and Atmospheric Administration (2017a).

This appendix deals with whether and how to consider SLR and future changes in precipitation and wind hazard. The project team used the recent and widely cited estimates of LSL rise offered by Kopp et al. (2014). Their estimates account for land water storage, Greenland ice sheet melt, Antarctic ice sheet melt, glacier and ice cap mass balance (GIC), oceanographic processes (thermal expansion and regional effects), and the non-climatic background. At a global level, assuming greenhouse gas emissions continue to increase throughout the 21st century, the Representative Concentration Pathways (RCP), trajectory 8.5,

## NATURAL HAZARD MITIGATION SAVES:

Kopp et al. estimate a likely global average sea level (GASL) rise “of 0.6–1.0 m by 2100, with a very likely range of 0.5–1.2 m and a virtually certain (99% probability) range of 0.4–1.8 m.” See Kopp et al.’s (2014) Table 1 for a summary of their findings.

Kopp et al.’s upper limit of 1.8m is consistent with the 95th percentile estimated by Jevreja et al. (2014). Kopp et al.’s “likely” range expresses the average value  $\pm$  one standard deviation (oversimplifying slightly). Their very-likely range spans the mean  $\pm$  1.6 standard deviations. Their virtual-certainty range spans the mean  $\pm$  2.6 standard deviations.

Like other authors, Kopp et al. offer lower estimates of GSL for scenarios where greenhouse gas emissions peak in the 21st century, then decline: RCP 2.6 estimates GSL if emissions peak in the present decade and then decline; RCP 4.5 assumes emissions peak in 2040; and RCP 6 in 2080.

Despite the uncertainties in each RCP and the uncertainty about when the world will effectively cause emissions to decline (e.g., the choice between RCPs), the range in GSL is reasonably constrained: the mean values are 2.9 feet under a continuously increasing emissions pathway (RCP 8.5), 2.0 feet under a middle-of-the-road pathway (RCP 4.5), and 1.8 feet under the most optimistic pathway (RCP 2.6). Even within an assumption of an emissions pathway, the year-2100 GSL under each RCP is somewhat uncertain, but the range is not very large: on the order of  $\pm$  30%. The project team would consider an order of magnitude to represent a large degree of uncertainty; plus, or minus 30% would be considered a fairly well constrained range for many common structural engineering problems, such as the fundamental period of vibration of a building. The point is that despite various uncertainties, the overall range of possible global sea level (GSL) rise is fairly well constrained.

To return to the Kopp et al. (2014) estimates of LSL rise relative to 2000 levels in 2030, 2050, 2100, and beyond: their curves estimate LSL at 24 cities along the entire Atlantic, Gulf, and Pacific Coasts in the United States. If one thinks of the winners in LSL as places where sea level stays the same or decreases, and the losers as places where sea level increases, then Alaska is the big winner (LSL dropping as much as 3.5 feet by 2100), while the biggest losers are spread along the entire Atlantic and Gulf Coasts in the United States, with likely LSL rises up to 4 feet or more and 95th percentiles as high as 6.5 feet by 2100.

BCA has to consider uncertainty, but it is really about average values. The project team’s goal is therefore to provide best estimates of BCR, not best or worst cases, so the tails of LSL are of less interest here than mean values. The project team therefore considers the mean values of RCP 6 as the baseline emissions trajectory. The project later tests sensitivity of BCR to LSL using two extremes: a lower-bound LSL (5th percentile) of the most optimistic emissions trajectory (RCP 2.6) and an upper-bound LSL (95th percentile) of the most pessimistic trajectory (RCP 8.5). See Chapter 3 for ranges. For example, the lower-bound, mean, and upper-bound year-2100 LSL for New York City are 0.9, 2.5, and 5.1 feet, respectively. The values for Miami, FL, are similar: 0.9, 2.2, and 4.3 feet. For San Diego, CA, they are 0.9, 2.1, and 4.1 feet.

For the reader who is interested in worst cases, LSL becomes more catastrophic farther into the future under RCP 8.5: LSL of 12.4-feet in Charleston, South Carolina by the year 2200 means that the city, in

## NATURAL HAZARD MITIGATION SAVES:

which the highest elevation is approximately 14-feet, ceases to exist in its present location by the end of the next century.

Kopp et al. (2014) estimate of the contribution to GSL rise in centimeters under three assumptions of how well humanity controls greenhouse gases (called RCP. See Table A-4. Column headers 50, 17-83, etc., refer to percentiles. Components refer to the contribution to GSL from several sources.

**Table A-4:** Global sea-level rise projections.

cm	RCP 8.5					RCP 4.5					RCP 2.6				
	50	17-83	5-95	0.5-99.9	99.5	50	17-83	5-95	0.5-99.9	99.5	50	17-83	5-95	0.5-99.9	99.5
2100-Components															
GIC	18	14-21	11-24	7-29	<30	13	10-17	7-19	3-23	<25	12	9-15	7-17	3-20	<25
GIS	14	8-25	5-39	3-70	<95	9	4-15	2-23	0-40	<55	6	4-12	3-17	2-31	<45
AIS	4	-8 to 15	-11 to 33	-14 to 91	<155	5	-5 to 16	-9 to 33	-11 to 88	<150	6	-4 to 17	-8 to 35	-10 to 93	<155
TE	37	28-46	22-52	12-62	<65	26	18-34	13-40	4-48	<55	19	13-26	8-31	1-38	<40
LWS	5	3-7	2-8	-0 to 11	<11	5	3-7	2-8	-0 to 11	<11	5	3-7	2-8	-0 to 11	<11
Total	79	62-100	52-121	39-176	<245	59	45-77	36-93	24-147	<215	50	37-65	29-82	19-141	<210
Projections by year															
2030	14	12-17	11-18	8-21	<25	14	12-16	10-18	8-20	<20	14	12-16	10-18	8-20	<20
2050	29	24-34	21-38	16-49	<60	26	21-31	18-35	14-44	<55	25	21-29	18-33	14-43	<55
2100	79	62-100	52-121	39-176	<245	59	45-77	36-93	24-147	<215	50	37-65	29-82	19-141	<210
2150	130	100-180	80-230	60-370	<540	90	60-130	40-170	20-310	<480	70	50-110	30-150	20-290	<460
2200	200	130-280	100-370	60-630	<950	130	70-200	40-270	10-520	<830	100	50-160	30-240	10-500	<810

Note: GIC = glacier and ice cap mass balance, GIS = Greenland ice sheet melt, AIS = Antarctic ice sheet melt, TE = thermal expansion and regional effects, and LWS = land water storage.



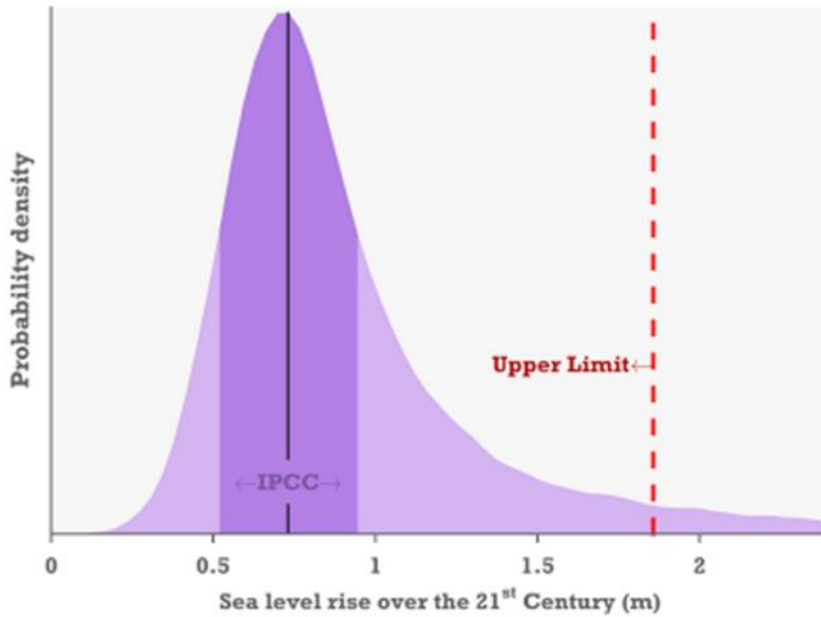

Note: Their 1.8-meter upper limit (95th percentile) is about the same as the 99th percentile of Kopp et al. (2014), which only means that Jevreja et al. express a so somewhat more pessimistic worst case than Kopp et al., not that they substantially disagree.

Figure A-1: Jevreja et al. (2014) estimated the probability distribution function of GSL by the year 2100.

Table A-5: LSL relative to year 2000, in feet, based on Kopp et al. (2014) projections.

Location	Year	Lower	Baseline	Upper
Portland, ME	2030	0.2	0.6	0.9
	2050	0.3	1.0	1.7
	2100	0.4	2.1	4.6
Boston, MA	2030	0.3	0.6	1
	2050	0.4	1.1	1.8
	2100	0.7	2.3	4.9
Newport, RI	2030	0.3	0.7	1.1
	2050	0.5	1.2	1.9
	2100	0.8	2.4	5
New York, NY	2030	0.3	0.7	1.2
	2050	0.5	1.2	1.9
	2100	0.9	2.5	5.1
Atlantic City, NJ	2030	0.4	0.8	1.1
	2050	0.7	1.3	2

## NATURAL HAZARD MITIGATION SAVES:

Location	Year	Lower	Baseline	Upper
	2100	1.2	2.8	5.3
Philadelphia, PA	2030	0.3	0.7	1.1
	2050	0.5	1.2	1.9
	2100	0.9	2.5	5
Lewes, DE	2030	0.4	0.7	1.1
	2050	0.7	1.2	1.9
	2100	1.1	2.7	5
Baltimore, MD	2030	0.3	0.7	1
	2050	0.6	1.2	1.8
	2100	1.0	2.5	4.9
Washington, DC	2030	0.3	0.7	1
	2050	0.6	1.2	1.8
	2100	1.0	2.5	4.8
Norfolk, VA	2030	0.5	0.8	1.1
	2050	0.8	1.4	2
	2100	1.4	2.9	5.2
Wilmington, NC	2030	0.3	0.6	0.9
	2050	0.5	1.0	1.6
	2100	0.8	2.2	4.3
Charleston, SC	2030	0.4	0.7	0.9
	2050	0.7	1.1	1.6
	2100	1.0	2.4	4.5
Fort Pulaski, GA	2030	0.4	0.7	0.9
	2050	0.7	1.1	1.7
	2100	1.1	2.4	4.6
Miami, FL	2030	0.3	0.6	0.9
	2050	0.6	1.0	1.5
	2100	0.9	2.2	4.3
Pensacola, FL	2030	0.2	0.5	0.8
	2050	0.5	0.9	1.5
	2100	0.7	2.1	4.2
Grand Isle, LA	2030	0.9	1.2	1.5

## NATURAL HAZARD MITIGATION SAVES:

Location	Year	Lower	Baseline	Upper
	2050	1.6	2.1	2.6
	2100	3.0	4.4	6.5
Galveston, TX	2030	0.7	1.0	1.2
	2050	1.2	1.6	2.2
	2100	2.1	3.5	5.7
San Diego, CA	2030	0.3	0.5	0.6
	2050	0.5	0.9	1.3
	2100	0.9	2.1	4.1
San Francisco, CA	2030	0.3	0.4	0.6
	2050	0.4	0.8	1.3
	2100	0.8	2.0	4
Astoria, OR	2030	0.0	0.2	0.3
	2050	0.0	0.4	0.8
	2100	0.0	1.1	3
Seattle, WA	2030	0.2	0.4	0.5
	2050	0.4	0.8	1.1
	2100	0.7	1.9	3.7
Juneau, AK	2030	-1.3	-1.2	-1
	2050	-2.2	-1.9	-1.5
	2100	-4.4	-3.4	-1.7
Anchorage, AK	2030	-0.2	0.2	0.4
	2050	-0.4	0.2	0.8
	2100	-0.6	0.5	2
Honolulu, HI	2030	0.3	0.5	0.7
	2050	0.5	0.9	1.4
	2100	0.9	2.2	4.6

## Appendix G. Quality Assurance Procedures

### G.1. PROJECT QUALITY ASSURANCE PLAN

To assure the quality of the findings, the project team follows these quality assurance (QA) methods:

1. The project team clearly documents all procedures in the Interim Study, consistent with a standard of reproducibility common in scholarly journals, especially those of the relevant fields of earth science, engineering, economics, and social science. To the extent practical, the project team members offer underlying data, but do not hold themselves to a higher standard of providing data than those of journals in their fields. For the sake of brevity and efficiency, the project team does not commit to reproducing or explaining as in a textbook any prior art that is well documented elsewhere. The project team cites those works for the reader's benefit and provides complete bibliographic references.
2. This is an applied research project, not basic research. The project team does not commit to search for data that *may* exist, *ought* to exist, or *ought* to be available to the public. It does not commit to improve on the state of the practice or state of the art, although as scholars the project team does take advantage of convenient opportunities to advance the state of the art in a few useful and important ways. (See Appendix E for details.)
3. All data and procedures are based to the maximum extent practical on published, peer-reviewed, highly cited works. For the sake of scientific rigor, the project team uses no proprietary data or procedures. When confronted with a choice among competing procedures or data sources, the project team selects the ones that are both practical and most well accepted. The project team does not demand absolute consensus among relevant experts, but does aim for the best available choice.
4. The baseline for all procedures and data is the *2005 Mitigation Saves* study. The project team does not take the trouble to repeat any defense of the *2005 Mitigation Saves* study procedures or choices that are already documented in that earlier report. That work has been highly cited and has stood the test of time over the decade since its publication.
5. Where there is significant uncertainty or no census, the project team leans toward a conservative procedure, e.g., one that estimates lower benefits or higher costs.
6. The goal of the Interim Study is to provide best estimates of the BCR of natural hazard mitigation. Still, the project team tries to acknowledge significant uncertainty where it exists and test the sensitivity of BCR to major uncertain variables using a deterministic procedure call tornado-diagram analysis, as in the *2005 Mitigation Saves* study.

## NATURAL HAZARD MITIGATION SAVES:

7. The project team performs internal checks of all results. Project team members choose internal QA procedures that best suit their organizations, as long as those procedures satisfy the project team's oversight committee members. (Regarding the oversight committee, see item 8.)
8. The National Institute of Building Sciences has engaged a large oversight committee of highly qualified experts. At least two experts represent each topic: flood, wind, earthquake, fire, economics, social sciences, and building codes. Oversight committee members generally include one scholar and one practitioner for each topic, to better ensure that both theory and practice are properly considered. The oversight committee formally met three times: a kickoff web meeting in December 2016, at the time of delivering the 33% draft of the *2017 Interim Report* to FEMA (February 2017), and email to review the near-final draft of the *2017 Interim Report* (September 2017). At these meetings, the project team presented the in-progress or near-final draft report to the oversight committee, who had two opportunities to provide feedback: during the presentation meeting and online during the week after the presentation meeting. The project team committed to addressing the oversight committee members' comments, although, to retain independence, the project team did not commit to completely satisfying the oversight committee on every point. Committee members (listed in Table A-6) were selected and appointed by the Institute in consultation with the project team and the FEMA contract officers. They work as subcontractors of the Institute, and are therefore independent of the project team.
9. The Institute, project team, and oversight committee formally met with a stakeholder group in February 2017 to optimize the project's objectives and the form of its deliverables. The main goal of these deliverables is to inform common natural hazard risk-mitigation decisions. They should be readily usable by people who make natural hazard risk-mitigation decisions, people who offer or formulate incentives to others to engage in natural hazard risk mitigation, or people who further develop risk-mitigation techniques and analysis procedures. The National Institute of Building Sciences and the project team also met informally with other stakeholders, such as economists and engineers from FEMA, DHS, and OMB, as well as other potential users of the Interim Study.

Table A-6: 2017 Interim Report oversight committee.

Topic	Person	Affiliation
Flood	Neil Blais <sup>(a)</sup>	Blais & Associates
	Gavin Smith	Coastal Resilience Center of Excellence, University of North Carolina
Wind	Tim Reinhold <sup>(b)</sup>	Insurance Institute for Business & Home Safety
	Peter Vickery	Applied Research Associates
Earthquake	Brent Woodworth <sup>(b)</sup>	Los Angeles Emergency Preparedness Foundation
	Lucy Jones	Dr. Lucy Jones Center for Science and Society
Wildfire	Mark Finney	U.S. Forest Service
	Kim Zagaris	California Office of Emergency Services
Economics	Phil Ganderton <sup>(b)</sup>	University of New Mexico
	Adam Rose <sup>(b)</sup>	University of Southern California
Social science	Lori Peek	Natural Hazards Center, University of Colorado
	Stan Drake	City of Moore, Oklahoma
	Jennifer Helgeson	National Institute of Standards and Technology
Codes	Steve Winkel	The Preview Group
	Terry McAllister	National Institute of Standards and Technology
	Tim Ryan	City of Overland Park, Kansas

(a) Committee chair

(b) Involved in the 2005 Mitigation Saves study.

## G.2. QA PROCEDURES FOR SEISMIC HAZARD AND SEISMIC VULNERABILITY

The project team used either of two procedures to check results.

**Approach 1:** Investigator A documents the procedures in terms of what is given and what is required, and then presents the solution, carrying out the calculations specified in the solution and documenting one or two samples of the calculations from end to end. The documentation and all relevant data are then provided to investigator B, who answers the following questions:

1. Is the documentation clear? If not, investigator B requests that investigator A revises the calculations to make all the steps clear and easy to follow.
2. Do the calculations agree with standard practice? If you are not sure, ask investigator A to revise the calculations so that all equations are cited back to a source that you can easily find.

## NATURAL HAZARD MITIGATION SAVES:

3. Are the sample calculations correct, and do they agree with the results shown in the spreadsheet? If not, flag errors and ask investigator A to correct them.
4. Check the first and last output records.
5. Check the output records that are somehow highest and somehow lowest.
6. Spot-check 2 records at random from the middle.

**Approach 2:** Investigator A documents the procedures. Investigators A and B (or investigators B and C) carry out the calculations independently. If their results agree, it suggests that the documentation is clear and the calculations are correct.

## Appendix H. Discount Rate

### H.1. OPTIONS FOR SELECTING THE DISCOUNT RATE

The project team considered four options for selecting a discount rate for use in the study, and discussed them with economists at FEMA and OMB and with the economists on the oversight committee. See the options recapped below, with their advantages and disadvantages. With the approval of the oversight committee, the project team selected Option 3 as the best compromise.

1. Use the real interest rate (after-inflation cost of capital, as currently utilized in the Interim Study) as the discount rate.

Advantages: Consistent with the 2005 Mitigation Saves study. Consistent with principles of engineering economics.

Disadvantages: not useful to OMB.

2. Use OMB Circular A-4 as the discount rate (Office of Management and Budget 2003).

Advantages: useful to OMB.

Disadvantages: inconsistent with the 2005 Mitigation Saves study. Inconsistent with principles of engineering economics. Seems to conflate IRR analysis with BCA.

3. Use Option 1 as the baseline and publish Option 2 in a parallel section.

Advantages: consistent with the 2005 Mitigation Saves study. Consistent with principles of engineering economics. Provides OMB with the data they need.

Disadvantages: none apparent. Possibly confusing to some readers, but doubtful, since the 2005 Mitigation Saves study project team heard no objections to the 2005 Mitigation Saves study tornado diagram analysis used to test sensitivity of the BCR to the discount rate.

4. Reverse of 3: Use OMB Circular A-4 for the baseline, real cost of borrowing in sensitivity study in a parallel section, appendix, or other separate section (Office of Management and Budget 2003).

Advantages: provides OMB the data they need, and presents in an appendix or elsewhere results that are consistent with the 2005 Mitigation Saves study.

Disadvantages: baseline is inconsistent with the 2005 Mitigation Saves study and principles of engineering economics.

After discussion among the project team members, FEMA, and oversight committee economists (Ganderton and Rose), option 3 appeared best.



## H.2. REAL COST OF BORROWING

$r$  = real cost of borrowing = long-term cost of borrowing, less inflation

**Residential real cost of borrowing.** For residential 15-year and 30-year fixed-rate loans and jumbo loan, Wells Fargo charged 0.0401 to 0.0442 in December 2016<sup>41</sup>. This uses a conservative (higher) figure: that of 30-year fixed jumbo as of December 2016 was 0.0431. The Trading Economics website reported that the December 2016 U.S. inflation rate was 0.0210<sup>42</sup>. Thus,

$$r_{RES} = 0.0431 - 0.0210 = 0.0221$$

Equation A-1

**Commercial real cost of borrowing.** For a commercial mortgage, the interest rate is usually 0.5% to 1.0% higher than residential mortgage rates (AdvisoryHQ 2017), but as of this writing the two are approximately equal. Commercial Loan Direct<sup>43</sup> is charging 3.7% to 4.335%. A December 2016 U.S. Securities and Exchange Commission (SEC) filing reported that JP Morgan Chase<sup>44</sup> is currently charging 2.86% to 5.35%, with a weighted average mortgage rate of 0.0423, so take

$$r_{NRES} = 0.0423 - 0.0210 = 0.0213$$

Equation A-2

**Government real cost of borrowing.** Government borrowing is discounted using the composite rate for I bonds issued by the U.S. Department of the Treasury<sup>45</sup>, which from November 1, 2016, through April 30, 2017, was 0.0276. Also note that in December 2016, the return on Treasury inflation-protected securities (TIPS) real yield, as of November 1, 2016, was 0.0069 for a 30-year term, which agrees well with the value of rGOV used here:

$$r_{GOV} = 0.0276 - 0.0210 = 0.0066$$

Equation A-3

<sup>41</sup> From <https://www.wellsfargo.com/mortgage/rates/> in December 2016

<sup>42</sup> From <https://tradingeconomics.com/> in December 2016.

<sup>43</sup> From <https://www.commercialloandirect.com/commercial-rates.php> in December 2016

<sup>44</sup> From <http://www.secinfo.com/d1evd6.w48g.htm>, page 132.

<sup>45</sup> From [https://www.treasurydirect.gov/indiv/research/indepth/ibonds/res\\_ibonds\\_iratesandterms.htm](https://www.treasurydirect.gov/indiv/research/indepth/ibonds/res_ibonds_iratesandterms.htm), Dec 2016

### H.3. DISCOUNT RATES ACCORDING TO OMB CIRCULAR A-4

For purposes of calculating BCR for the benefit of OMB, use the values directed by OMB Circular A-4 (Office of Management and Budget 2003):

$$r_{A-1} = 0.07$$

$$r_{A-2} = 0.03$$

Equation A-4

## Appendix I. Actual Economic Life of North American Buildings

BCA requires a duration over which to recognize the benefit of the investment. BCRs for exceeding code require an estimate of the actual service life of new buildings—the number of years between when they are built and when they are demolished. BCRs for federal mitigation grants require an estimate of the remaining life of an existing building or of the part of a building that is being remediated. *The 2005 Mitigation Saves* study assumed a useful life of 50 years for retrofits to ordinary buildings and 100 years for lifeline facilities.

ASCE 7-10 encodes a 50-year design life of new buildings in its wind and earthquake design maps, but design life is not the same thing as actual service life. Emporis Corporation (2007) offers a database of high-rise buildings (generally 8 or more stories) worldwide. In the United States, the average existing high-rise building is already 50 years old, and 25% are already almost 70 years old. While the database obviously contains no data on buildings that have been demolished, it suggests that the true service life of any particular new U.S. building may be far longer than the design life assumed in ASCE 7.

Several sources offer guidance without underlying evidence. One highly cited work (Börjesson and Gustavsson 2000) suggest a building life cycle of 50 to 100 years, but not for U.S. construction. The U.S. Department of Defense assumes a 40-year useful life in life-cycle cost analyses<sup>46</sup>. DOE suggests that commercial buildings have median lifetimes of 50 to 65 years<sup>47</sup>.

O'Connor (2004) presents a rare work that offers observations of actual life of particular buildings: a demolition survey of Minneapolis/St. Paul, Minnesota that captured building age, building type, structural material, and reason for demolition for 227 buildings that were demolished between 2000 and 2003. These included 122 residential and 105 nonresidential buildings, among them 148 wood, 57 concrete, 10 steel, and the remaining 12 various combinations. She does not present an average age of demolished buildings, but rather the number of buildings by range of age at demolition, in 25-year increments (0-25, 26-50, 51-75, 76-100, and 101+). Using the midpoint of each age group one can estimate that the average building demolished between 2000 and 2003 in Minneapolis/St Paul was 73 years old. One can also estimate the figures for residential (89 years) and nonresidential (55 years). Maintenance costs and redevelopment dominate the reasons for demolition. O'Connor does not speculate on how life expectancy might differ in other locations or over time, e.g., during other points in the business cycle.

As shown above, the limited available data support an actual service life of a building between 50 and 75 years, with the value depending largely on maintenance costs and redevelopment. It seems reasonable to

---

<sup>46</sup> [http://wbdg.org/FFC/DOD/UFC/ufc\\_1\\_200\\_02\\_2016.pdf](http://wbdg.org/FFC/DOD/UFC/ufc_1_200_02_2016.pdf)

<sup>47</sup> U.S. Department of Energy (2011) Table 3.2.7

## **NATURAL HAZARD MITIGATION SAVES:**

take the service life of buildings in harsher environments, especially in coastal areas where maintenance costs tend to be higher, as 50 years, and that of buildings farther from the shoreline as 75 years.

## Appendix J. Cost of Greater Elevation

The *2017 Interim Report* of above-code measures examined, among other things, increasing the elevation of houses for greater flood resistance. A common approach to adding elevation is to raise the first floor on wooden piles, for which the construction cost appears in RSMMeans 2017 Assemblies Cost Data, Section A1020 160 2220. One can estimate the cost to raise a single-family dwelling as \$33 per foot of elevation per pile, and assume 25 piles required, spacing at 12-foot centers, average plan area of 2,400 sf, 9 additional piles at the perimeter (U.S. Census Bureau 2010b), or \$825 per foot of elevation. Wooden stairs add \$325 per foot of elevation (RSMMeans C2010 110 1150), for a total of approximately \$1,150 per foot of elevation.

Some houses have wheelchair ramps. How many, and at what cost? Examination of 682 sample houses in 5 coastal cities listed in vrbo.com suggests that approximately 5% are wheelchair accessible. (In Miami, Florida: 6 of 101 are wheelchair accessible = 6%; Biloxi, Mississippi: 6 of 26 = 23%; Galveston, Texas: 18 of 459 = 4%; Charleston, South Carolina: 1 of 54 = 2%; Tampa, Florida: 5 of 42 = 12%; total 36 of 682 = 5%). These data imply that on the order of 5% of new homes with greater elevation would also have wheelchair ramps. The 5% figure coincidentally agrees with HUD requirements that 5% of federally funded new homes in developments must comply with ADA requirements, and must therefore have wheelchair ramps. Realistically, the figure could rise in coming decades as the American population ages, but one can neglect this (possibly second-order) consideration. An informal survey of online estimates of the cost of permanent wheelchair ramps suggests costs range widely, from \$1,000 to \$3,000 per foot of elevation. (Sources: North Carolina State University College of Design, Center for Universal Design 2004, Networx 2011, ProMatcher 2017, Angie's List 2013. Add  $0.05 \times \$2,000 = \$100$  per foot of elevation for wheelchair ramps, accounting for the fact that only some new houses will be built with wheelchair ramps.

With nominal additional costs for utility risers and additional exterior closure material for ground-level storage space, the total cost is therefore approximately \$1,300 per foot of elevation.

## Appendix K. Details of Seismic Vulnerability

### K.1. PREFACE

This appendix provides details for the calculation of two aspects of seismic vulnerability: design to exceed certain I-Code requirements for earthquake (which one could call above-code design), and design to adopt I-Code requirements for earthquake (i.e., with a starting point that one could call below-code design). The two analyses were performed at different times: the former prior to the adoption of ASCE 7-16, the latter afterwards. For design to exceed I-Code requirements, the project team used the design maps and provisions of ASCE 7-10, and compared the performance of buildings design to meet those requirements (i.e., those of the 2015 I-Codes) with buildings that are stronger and stiffer than ASCE 7-10 requires by varying factors of 1.25, 1.5, and larger.

For design to adopt I-Code requirements—the later analysis—the project team used design maps and provisions of ASCE 7-16, and compared the design performance of buildings to meet those requirements (i.e., those of the 2018 I-Codes) with buildings that are weaker and more flexible than ASCE 7-16 requires by varying factors of 0.67, 0.44, and 0.30. References to design parameters hereafter in this appendix refer to ASCE 7-10. Parameter names did not change between ASCE 7-10 and ASCE 7-16, but some parameter values may have. Examples of parameter values presented hereafter in this appendix reflect ASCE 7-10.

### K.2. CALCULATING THE CAPACITY CURVE

Start by calculating the parameters of the capacity curve. It is defined by four parameters:  $D_y$ ,  $A_y$ ,  $D_u$ , and  $A_u$ . It is linear from (0,0) to  $(D_y, A_y)$ , describes a portion of an ellipse between  $(D_y, A_y)$  and  $(D_u, A_u)$ , and is flat to the right of  $D_u$ . For derivation of the following equations, see Porter (2009a and b), which draws on earlier editions of Federal Emergency Management Agency (2012e). One calculates these four parameter values from design parameters  $C_s$ ,  $T_e$ , and  $I_e$ , as follows:

Let,

$C_s$  = seismic response coefficient in the language of ASCE 7-10 Chapter 11. Hazus developers refer to  $C_s$  as design strength.

$T_e$  = approximate (elastic) fundamental period of the as-is ( $I_e = 1.0$ ) building. This is the mean estimate of elastic period, not the conservative (low) value from ASCE 7-10. For code-level design, one could use best-estimate values derived from regression analysis of actual building response by Chopra and Goel (2000). Alternatively, one could use the values tabulated by Federal Emergency Management Agency (2012e) in Table 5.5. The latter seems simpler and offers more assurance of consistency with Hazus.  $T_e$  is a function solely of model building type. See Table A-7.

## NATURAL HAZARD MITIGATION SAVES:

$I_e$  = (earthquake) importance factor from ASCE 7-10 Chapter 11. In the case of below-code design,  $I_e$  is taken as 0.67, 0.44, and 0.30, to reflect buildings that are less strong and stiff than current design.

Then using the equations in Figure 5.4 of Federal Emergency Management Agency (2012e):

$$A_y = \frac{C_s \gamma}{\alpha_1} \cdot I_e$$

Equation A-5

$$D_y = \frac{9.8 A_y T_e^2}{I_e}$$

Equation A-6

$$A_u = \lambda A_y$$

Equation A-7

$$D_u = \lambda \mu D_y$$

Equation A-8

The parameters  $\gamma$ ,  $\alpha_1$ ,  $\alpha_2$ , and  $\lambda$  vary by model building type and are tabulated in Federal Emergency Management Agency (2012e) Chapter 5. Table A-7 repeats them for convenient reference. The reader who is familiar with the Hazus methodology may notice the slight difference between Equation A-5 and Equation A-6 and their counterparts in Federal Emergency Management Agency (2012e):  $I_e$  appears here but not there. It appears in the numerator of Equation A-5 because strength increases in proportion to  $I_e$ . It appears in the denominator of Equation A-6 to keep  $D_y$  constant regardless of  $A_y$ , that is, to increase stiffness in proportion to strength.

**Table A-7:** Capacity curve parameters.

Building type	Roof height (ft)	Period $T_e$ (sec)	Modal factor, weight, $\alpha_1$	Modal factor, height, $\alpha_2$	Overstrength ratio, yield $\gamma$	Overstrength ratio, ultimate, $\lambda$
W1	14	0.35	0.75	0.75	1.5	3
W2	24	0.4	0.75	0.75	1.5	2.5
S1L	24	0.5	0.8	0.75	1.5	3
S1M	60	1.08	0.8	0.75	1.25	3
S1H	156	2.21	0.75	0.6	1.1	3
S2L	24	0.4	0.75	0.75	1.5	2
S2M	60	0.86	0.75	0.75	1.25	2

## NATURAL HAZARD MITIGATION SAVES:

Building type	Roof height (ft)	Period $T_e$ (sec)	Modal factor, weight, $\alpha_1$	Modal factor, height, $\alpha_2$	Overstrength ratio, yield $\gamma$	Overstrength ratio, ultimate, $\lambda$
S2H	156	1.77	0.65	0.6	1.1	2
S3	15	0.4	0.75	0.75	1.5	2
S4L	24	0.35	0.75	0.75	1.5	2.25
S4M	60	0.65	0.75	0.75	1.25	2.25
S4H	156	1.32	0.65	0.6	1.1	2.25
S5L	24	0.35	0.75	0.75	1.5	2
S5M	60	0.65	0.75	0.75	1.25	2
S5H	156	1.32	0.65	0.6	1.1	2
C1L	20	0.4	0.8	0.75	1.5	3
C1M	50	0.75	0.8	0.75	1.25	3
C1H	120	1.45	0.75	0.6	1.1	3
C2L	20	0.35	0.75	0.75	1.5	2.5
C2M	50	0.56	0.75	0.75	1.25	2.5
C2H	120	1.09	0.65	0.6	1.1	2.5
C3L	20	0.35	0.75	0.75	1.5	2.25
C3M	50	0.56	0.75	0.75	1.25	2.25
C3H	120	1.09	0.65	0.6	1.1	2.25
PC1	15	0.35	0.5	0.75	1.5	2
PC2L	20	0.35	0.75	0.75	1.5	2
PC2M	50	0.56	0.75	0.75	1.25	2
PC2H	120	1.09	0.65	0.6	1.1	2
RM1L	20	0.35	0.75	0.75	1.5	2
RM1M	50	0.56	0.75	0.75	1.25	2
RM2L	20	0.35	0.75	0.75	1.5	2
RM2M	50	0.56	0.75	0.75	1.25	2
RM2H	120	1.09	0.65	0.6	1.1	2
URML	15	0.35	0.5	0.75	1.5	2
URMM	35	0.5	0.75	0.75	1.25	2
MH	10	0.35	1	1	1.5	2

**Values of  $C_s$ .** Values of  $S_s$  range from 0.037g (North Dakota) to 3.06g (northwest Tennessee).  $S_1$  ranges from 0.026g (central Texas) to 1.26g (northwest Tennessee), using maps of  $MCE_R$  in ASCE 7-10. Depending on site conditions,  $S_{M5}$  could range from 0.033g to 3.67g;  $S_{M1}$  from 0.021g to 2.5g, considering  $F_a$  and  $F_v$



## NATURAL HAZARD MITIGATION SAVES:

values from the 2015 NEHRP Provisions Tables 11.4-1 and 11.4-2. R-values range from 1 to 8 (ASCE 7-10 Table 12.2-1). All this implies that  $C_s$  values can range from less than 0.01g to greater than 3g, more than two orders of magnitude. The project team therefore constructed seismic vulnerability functions for buildings with  $C_s$  values (in terms of 5% damped elastic spectral acceleration response at 0.2-sec period and at 1-sec period) in 31 logarithmic increments of  $10^{-2}$ ,  $10^{-1.9}$ , ...  $10^1$  g.

**Table A-8:** Values of ductility capacity  $\mu$ .

Building type	High code $\mu$
W1	8
W2	8
S1L	8
S1M	5.3
S1H	4
S2L	8
S2M	5.3
S2H	4
S3	8
S4L	8
S4M	5.3
S4H	4
S5L	Obsolete
S5M	Obsolete
S5H	Obsolete
C1L	8
C1M	5.3
C1H	4
C2L	8
C2M	5.3
C2H	4
C3L	Obsolete
C3M	Obsolete
C3H	Obsolete
PC1	8
PC2L	8
PC2M	5.3

## NATURAL HAZARD MITIGATION SAVES:

Building type	High code $\mu$
PC2H	4
RM1L	8
RM1M	5.3
RM2L	8
RM2M	5.3
RM2H	4
URML	Obsolete
URMM	Obsolete
MH	6

**Values of  $I_e$ .** This examines values of  $I_e$  equal to 1.0, 1.25, 1.5, 2.0, 3.0, ... 8.0. (The last of which would be like designing the most ductile system to be elastic.)

**Table A-9:** Damping coefficients  $\kappa$  for medium-duration ( $5.5 \leq M < 7.5$ ) earthquakes and high-code buildings.

MBTID	Building type	$\kappa$ ( $5.5 \leq M < 7.5$ )
1	W1	0.8
2	W2	0.6
3	S1L	0.6
4	S1M	0.6
5	S1H	0.6
6	S2L	0.5
7	S2M	0.5
8	S2H	0.5
9	S3	0.5
10	S4L	0.5
11	S4M	0.5
12	S4H	0.5
13	S5L	0.3
14	S5M	0.3
15	S5H	0.3
16	C1L	0.6

## NATURAL HAZARD MITIGATION SAVES:

MBTID	Building type	$\kappa$ ( $5.5 \leq M < 7.5$ )
17	C1M	0.6
18	C1H	0.6
19	C2L	0.6
20	C2M	0.6
21	C2H	0.6
22	C3L	0.3
23	C3M	0.3
24	C3H	0.3
25	PC1	0.5
26	PC2L	0.5
27	PC2M	0.5
28	PC2H	0.5
29	RM1L	0.6
30	RM1M	0.6
31	RM2L	0.6
32	RM2M	0.6
33	RM2H	0.6
34	URML	0.3
35	URMM	0.3
36	MH	0.4

Select a set of  $S_d$  values at which to evaluate the capacity curve. This uses 51 logarithmic increments  $10^{-3}$ ,  $10^{-2.9}$ , ...  $10^2$  inches. One calculates  $S_a$  for each value of  $S_d$  as follows:

$$\begin{aligned}
 S_a &= S_d A_y / D_y && S_d < D_y \\
 &= A_0 + b \sqrt{1 - \frac{(S_d - D_u)^2}{a^2}} && D_y \leq S_d < D_u \\
 &= A_u && D_u \leq S_d
 \end{aligned}$$

Equation A-9

## NATURAL HAZARD MITIGATION SAVES:

Where,

$$b = \frac{D_y(A_y - A_u)^2 - (D_y - D_u)A_y(A_y - A_u)}{(D_y - D_u)A_y - 2D_y(A_y - A_u)}$$
$$a = \sqrt{\frac{-D_y(D_y - D_u)b^2}{A_y(A_y - A_u + b)}}$$
$$A_0 = A_u - b$$

Equation A-10

At each value of  $S_d$  below  $D_y$ , effective damping equals elastic damping ratio  $B_E$ . For  $S_d$  above  $D_y$ , effective damping is calculated as:

$$B_{eff} = B_E + \kappa \left( \frac{2}{\pi} \left[ 1 - \frac{K_s}{K_E} \right] \right)$$

Equation A-11

Where,

$$K_s = \frac{S_a}{S_d}$$

Equation A-12

$$K_E = \frac{A_y}{D_y}$$

Equation A-13

This evaluates Equation A-5 through Equation A-13 for each point on the capacity curve (that is, each  $S_d$  value) and for each combination of model building type,  $C_s$  level and  $l_e$  level. Note that one can exclude the obsolete model building types S5L, S5M, S5H (steel frame with URM infill, low- mid- and high-rise), C3L, C3M, C3H (low-, mid- and high-rise concrete frame with URM infill), and URML and URMM (low- and mid-rise URM buildings).

### K.3. CALCULATE INPUT MOTION FOR EACH POINT ON THE CAPACITY CURVE

The index spectrum represents an idealized 5% damped response spectrum at various values of period  $T$ , in the space of spectral displacement response on the  $x$  axis and spectral acceleration response on the  $y$  axis. See Porter (2009a) for the derivation of the following relationships.

First determine whether the performance point lies on the constant-acceleration or constant velocity portion of the idealized response spectrum (ignoring the constant-displacement portion, which only the tallest buildings and rarest cases involve). The answer depends on whether the period at the performance point is less than or greater than the period corresponding to the intersection of the constant-acceleration and constant-velocity portions. Let  $T$  denote the period of the performance point, in seconds. As before,  $S_d$  is the  $x$ -coordinate of the performance point in inches and  $S_a$  is its  $y$ -coordinate in units of gravity. Then

$$T = 0.32\sqrt{S_d/S_a}$$

Equation A-14

Let  $T_{AVD}$  denote the period at which the constant-acceleration and constant-velocity portions of the response spectrum intersect. As shown in Porter (2009a),  $T_{AVD}$  varies by seismic domain (plate boundary, denoted by WUS, or continental interior, denoted by CEUS, magnitude  $M$ , distance from the fault rupture to the site  $R$ , NEHRP site class, and effective damping ratio  $B_{eff}$ . For probabilistic risk analysis, one uses  $M = 7$ ,  $R = 20$  km, and NEHRP site class = D. Under these constraints, one can find that  $T_{AVD}$  can be reasonably approximated as:

$$T_{AVD} = 2.67 \cdot B_{eff}^3 - 1.73 \cdot B_{eff}^2 + 1.09 \cdot B_{eff} + 0.55$$

Equation A-15

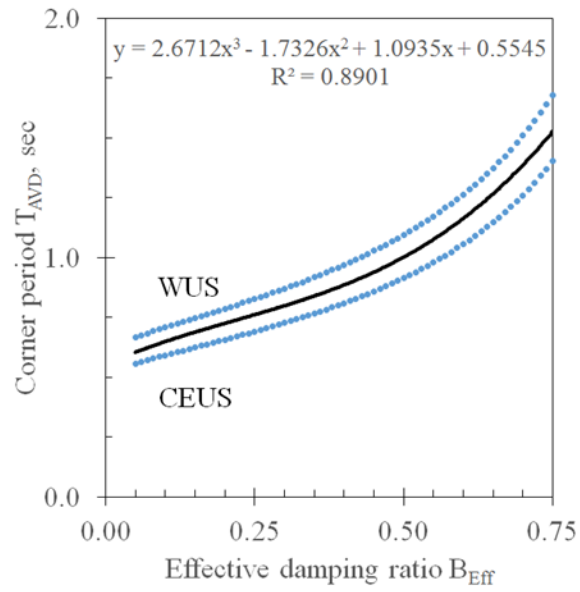

Figure 7-2: Corner period  $T_{AVD}$  for  $M=7$ ,  $R=20$  km, soil=D, versus effective damping ratio.

Table A-10:  $F_a$  as a function of SA02.

Site class	SA02	$F_a$
D	$\leq 0.40$	1.60
D	0.50	1.54
D	0.60	1.47
D	0.70	1.40
D	0.80	1.31
D	0.90	1.20
D	1.00	1.15
D	1.10	1.10
D	1.20	1.04
D	$\geq 1.30$	1.00

**Table A-11:**  $F_v$  as a function of  $SA_{10BC}$  for site class D.

Site class	$SA_{10BC}$	$F_v$
D	$\leq 0.20$	2.40
D	0.30	2.36
D	0.40	2.29
D	0.50	2.21
D	0.60	2.13
D	0.70	2.05
D	0.80	1.99
D	0.90	1.95
D	1.00	1.91
D	1.10	1.87
D	1.20	1.83
D	1.30	1.79
D	1.40	1.75
D	$\geq 1.50$	1.71

If  $T \leq T_{AVD}$ , one uses  $S_a$ ,  $S_d$ , and  $B_{Eff}$  previously calculated for each point on the capacity curve, and calculates the site-amplified 5% damped short-period spectral acceleration response, denoted by  $SA_{02}$ , using Equation A-16.

$$SA_{02} = 2.12 S_a / (3.21 - 0.68 \ln [100 B_{Eff}])$$

Equation A-16

The site-amplified 5% damped 1-second spectral acceleration response, denoted by  $SA_{10}$ , is given by,

$$SA_{10BC} = SA_{02} \cdot \frac{1}{(S_S/S_1)} \cdot \frac{1}{F_a(SA_{02})}$$

$$SA_{10} = SA_{10BC} \cdot F_v(SA_{10BC})$$

Equation A-17

where  $(S_S/S_1)$  is the spectral acceleration response factor, taken here as 2.75 for simplicity (it takes on a value of 3.0 in CEUS and 2.5 in WUS). The term  $F_a(SA_{02})$  refers to the value of  $F_a$  given that the site-amplified 5%-damped short-period spectral acceleration response is  $SA_{02}$ . Tables [Table A-10](#) and [Table A-11](#) give  $F_a(SA_{02})$  and  $F_v(SA_{10BC})$  in 0.1-g increments for Site Class D.

## NATURAL HAZARD MITIGATION SAVES:

If  $T > T_{AVD}$ , one uses  $S_a$ ,  $S_d$ , and  $B_{Eff}$  previously calculated for each point on the capacity curve, calculates the site-amplified 5% damped 1-sec spectral acceleration response using

$$SA10 = 0.528 \cdot \sqrt{S_a S_d} / (2.31 - 0.411 \ln [100 B_{Eff}])$$

Equation A-18

and then the site-amplified 5% damped short-period spectral acceleration response is given by

$$SA02_{BC} = SA10 \cdot (S_s/S_1) \cdot \frac{1}{F_v(SA10)}$$

$$SA02 = SA02_{BC} \cdot F_a(SA02_{BC})$$

Equation A-19

where  $(S_s/S_1)$  is taken as 2.75 as before,  $F_v(SA10)$  refers to the value of  $F_v$  given that the site-amplified 5%-damped 1-second spectral acceleration response is  $SA10$ . Tables [Table A-12](#) and [Table A-13](#) give  $F_a(SA02_{BC})$  and  $F_v(SA10)$  in 0.1-g increments for site class D.

Repeat these calculations for each point on the capacity curve and for each combination of model building type,  $C_s$  level, and  $I_e$  level. As before, omit the obsolete model building types S5L, S5M, S5H, C3L, C3M, C3H, URML, and URMM.

**Table A-12:**  $F_a$  as a function of  $SA02_{BC}$  for site class D.

Site class	$SA02_{BC}$	$F_a$
D	$\leq 0.20$	1.60
D	0.30	1.56
D	0.40	1.48
D	0.50	1.40
D	0.60	1.32
D	0.70	1.24
D	0.80	1.18
D	0.90	1.14
D	1.00	1.10
D	1.10	1.06
D	1.20	1.02
D	$\geq 1.30$	1.00



Table A-13:  $F_v$  as a function of SA10 for site class D.

Site class	SA10	$F_v$
D	$\leq 0.60$	2.40
D	0.70	2.37
D	0.80	2.33
D	0.90	2.29
D	1.00	2.25
D	1.10	2.21
D	1.20	2.17
D	1.30	2.12
D	1.40	2.07
D	1.50	2.01
D	1.60	1.99
D	1.70	1.96
D	1.80	1.94
D	1.90	1.91
D	2.00	1.89
D	2.10	1.86
D	2.20	1.83
D	2.30	1.80
D	2.40	1.77
D	2.50	1.73
D	$\geq 2.60$	1.71

## **K.4. CALCULATE DAMAGE FOR EACH POINT ON THE CAPACITY CURVE**

The damageable building components are idealized as comprising three parts: displacement-sensitive structural elements, displacement-sensitive nonstructural elements, and acceleration-sensitive nonstructural elements, each with five possible damage states in the following order: none (damage state is shown by  $d = 0$ ), slight ( $d = 1$ ), moderate ( $d = 2$ ), extensive ( $d = 3$ ), and complete ( $d = 4$ ). Part of the structure can also collapse; therefore, the damage state is represented by  $d = 5$ . The probabilistic damage state of each of these three elements is evaluated using fragility functions that are idealized as lognormal

cumulative distribution functions. The probability that an element is in one of these damage states is taken as the difference in probability between it and that of the next higher damage state.

Equation A-20 represents the probabilistic damage state to the structural elements. Equation A-21 does the same for the nonstructural drift-sensitive element (note no damage state 5, which refers to collapse). Equation A-22 does the same for the acceleration-sensitive element (note that the input parameter is  $S_a$  at the performance point, not  $S_d$ ). In all three equations,  $P[A|B]$  denotes the probability that statement  $A$  is true given that statement  $B$  is true,  $D_s$  denotes uncertain damage state of the structural element (the meaning of the subscript  $s$ ),  $D_{nd}$  that of the nonstructural drift-sensitive element (note subscript  $nd$ ), and  $D_{na}$  that of the nonstructural acceleration-sensitive element ( $na$ ). Parameter  $d$  denotes a particular value of  $D_s$ ,  $D_{nd}$ , or  $D_{na}$  ( $0 =$  undamaged,  $1 =$  slight damage,  $2 =$  moderate damage,  $3 =$  extensive damage,  $4 =$  complete, and  $5 =$  collapse).  $S_d$  denotes spectral displacement response at the performance point,  $\Phi()$  denotes the standard normal cumulative distribution function evaluated at the expression in parentheses,  $\ln()$  denotes the natural logarithm of the expression inside the parentheses. The parameters  $\theta$  and  $\beta$  are the median capacity and standard deviation of the natural logarithm of capacity. They vary by element, building type, and damage state. Their damage states are denoted by their first subscript, and the element to which they refer is denoted by the second subscript: For example,  $\theta_{1,s}$  denotes the median capacity of damage state 1 for the structural element ( $s$ ). The parameter  $P_c$  denotes the fraction of all building occupiable floor area that is already in the complete damage state that is also collapsed. One repeats these calculations for each point on the capacity curve and for each combination of model building type,  $C_s$  level and  $I_e$  level.

$$\begin{aligned}
 P[D_s = d | S_d = x] &= 1 - \Phi\left(\frac{\ln(x/\theta_{1,s})}{\beta_{1,s}}\right) & d = 0 \\
 &= \Phi\left(\frac{\ln(x/\theta_{d,s})}{\beta_{d,s}}\right) - \Phi\left(\frac{\ln(x/\theta_{d+1,s})}{\beta_{d+1,s}}\right) & 1 \leq d \leq 3 \\
 &= (1 - P_c) \Phi\left(\frac{\ln(x/\theta_{4,s})}{\beta_{4,s}}\right) & d = 4 \\
 &= P_c \Phi\left(\frac{\ln(x/\theta_{4,s})}{\beta_{4,s}}\right) & d = 5
 \end{aligned}$$

Equation A-20

$$\begin{aligned}
 P[D_{nd} = d | S_d = x] &= 1 - \Phi\left(\frac{\ln(x/\theta_{1,nd})}{\beta_{1,nd}}\right) & d = 0 \\
 &= \Phi\left(\frac{\ln(x/\theta_{d,nd})}{\beta_{d,nd}}\right) - \Phi\left(\frac{\ln(x/\theta_{d+1,nd})}{\beta_{d+1,nd}}\right) & 1 \leq d \leq 3 \\
 &= \Phi\left(\frac{\ln(x/\theta_{4,nd})}{\beta_{4,nd}}\right) & d = 4
 \end{aligned}$$

Equation A-21

$$\begin{aligned}
 P[D_{na} = d | S_a = y] &= 1 - \Phi\left(\frac{\ln(y/\theta_{1,na})}{\beta_{1,na}}\right) & d = 0 \\
 &= \Phi\left(\frac{\ln(y/\theta_{d,na})}{\beta_{d,na}}\right) - \Phi\left(\frac{\ln(y/\theta_{d+1,na})}{\beta_{d+1,na}}\right) & 1 \leq d \leq 3 \\
 &= \Phi\left(\frac{\ln(y/\theta_{4,na})}{\beta_{4,na}}\right) & d = 4
 \end{aligned}$$

Equation A-22

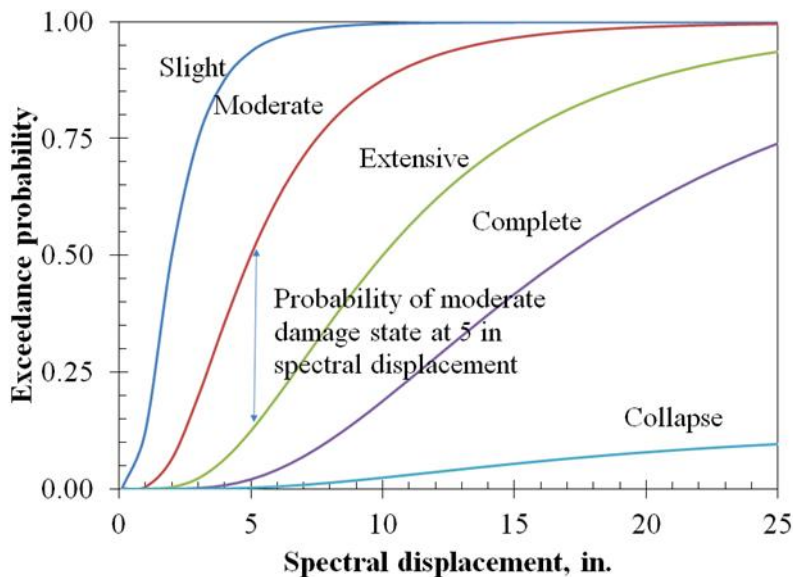

Figure A-3: Illustration of probabilistic damage state for structural components.

For any building type and performance point ( $S_d, S_a$ ), calculate the 13 probabilities: the probability that the structural component is in each of 5 damage states; the probability that the nonstructural drift sensitive component is in each of 4 damage states; and the probability that the nonstructural acceleration-sensitive

## NATURAL HAZARD MITIGATION SAVES:

component is in each of 4 damage states. The calculation requires ( $S_d, S_a$ ), 12 values of  $\theta$  (one for each of 3 components and each of 4 damage states), 12  $\beta$  values (one for each of 3 components and each of 4 damage states), and 1 value for  $P_c$ .

Repeat for each combination of model building type,  $C_s$  level and  $l_e$  level, omitting the obsolete model building types S5L, S5M, S5H, C3L, C3M, C3H, URML, and URMM.

### K.5. CALCULATE BUILDING REPAIR COST AS A FRACTION OF BUILDING REPLACEMENT COST

One assigns an expected value of loss to each element and damage state, and applies the theorem of total probability to estimate the expected value of loss for the building as a whole (denoted by  $L_b$ ), as shown in Equation A-23. In the equation,  $L_b$  denotes the expected value of loss as a fraction of value exposed given excitation  $x$  and  $L_{d,s}$  denotes the expected value of loss given the structural element in a particular damage state  $d$ . In the case of repair costs, losses accumulate from all three elements. The first summand in Equation A-23 refers to repair costs to the structural element (note the subscript  $s$ ). The second summand adds up repair costs for the nonstructural drift-sensitive element (note subscript  $nd$ ). The third adds repair costs for the nonstructural acceleration-sensitive element (note subscript  $na$ ). See Table A-14 for parameter values of repair cost  $L_{d,s}$ , Table A-15 for  $L_{d,ns}$ , and Table A-16 for  $L_{d,na}$ , all adapted from Federal Emergency Management Agency (2012e). These parameter values vary by occupancy class, so one repeats for each combination of model building type, occupancy class,  $C_s$  level and  $l_e$  level.

$$L_b = \sum_{d=1}^4 P[D_s = d | S_d = x] \cdot L_{d,s} + \sum_{d=1}^4 P[D_{nd} = d | S_d = x] \cdot L_{d,nd} + \sum_{d=1}^4 P[D_{na} = d | S_a = y] \cdot L_{d,na}$$

Equation A-23

**Table A-14:** Structural repair costs as a fraction for building replacement cost (new), *Ld, s.*

No.	Label	Occupancy Class	1. Slight	2. Mod	3. Ext	4. Com
1	RES1	Single-Family Dwelling	0.005	0.023	0.117	0.234
2	RES2	Mobile Home	0.004	0.024	0.073	0.244
3-8	RES3a-f	Multi-Family Dwelling	0.003	0.014	0.069	0.138
9	RES4	Temporary Lodging	0.002	0.014	0.068	0.136
10	RES5	Institutional Dormitory	0.004	0.019	0.094	0.188
11	RES6	Nursing Home	0.004	0.018	0.092	0.184
12	COM1	Retail Trade	0.006	0.029	0.147	0.294
13	COM2	Wholesale Trade	0.006	0.032	0.162	0.324
14	COM3	Personal and Repair Services	0.003	0.016	0.081	0.162
15	COM4	Professional/Technical/Business Services	0.004	0.019	0.096	0.192
16	COM5	Banks/Financial Institutions	0.003	0.014	0.069	0.138
17	COM6	Hospital	0.002	0.014	0.070	0.140
18	COM7	Medical Office/Clinic	0.003	0.014	0.072	0.144
19	COM8	Entertainment & Recreation	0.002	0.010	0.050	0.100
20	COM9	Theaters	0.003	0.012	0.061	0.122
21	COM10	Parking	0.013	0.061	0.304	0.609
22	IND1	Heavy	0.004	0.016	0.078	0.157
23	IND2	Light	0.004	0.016	0.078	0.157
24	IND3	Food/Drugs/Chemicals	0.004	0.016	0.078	0.157
25	IND4	Metals/Minerals Processing	0.004	0.016	0.078	0.157
26	IND5	High Technology	0.004	0.016	0.078	0.157
27	IND6	Construction	0.004	0.016	0.078	0.157
28	AGR1	Agriculture	0.008	0.046	0.231	0.462
29	REL1	Church/Membership Organization	0.003	0.020	0.099	0.198
30	GOV1	General Services	0.003	0.018	0.090	0.179
31	GOV2	Emergency Response	0.003	0.015	0.077	0.153
32	EDU1	Schools/Libraries	0.004	0.019	0.095	0.189
33	EDU2	Colleges/Universities	0.002	0.011	0.055	0.110

**Table A-15:** Nonstructural drift-sensitive repair costs as a fraction for building replacement cost (new),  $L_d n_d$ .

No.	Label	Occupancy Class	1. Slight	2. Mod	3. Ext	4. Com
1	RES1	Single-Family Dwelling	0.010	0.050	0.250	0.500
2	RES2	Mobile Home	0.008	0.038	0.189	0.378
3-8	RES3a-f	Multi-Family Dwelling	0.009	0.043	0.213	0.425
9	RES4	Temporary Lodging	0.009	0.043	0.216	0.432
10	RES5	Institutional Dormitory	0.008	0.040	0.200	0.400
11	RES6	Nursing Home	0.008	0.041	0.204	0.408
12	COM1	Retail Trade	0.006	0.027	0.138	0.275
13	COM2	Wholesale Trade	0.006	0.026	0.132	0.265
14	COM3	Personal and Repair Services	0.007	0.034	0.169	0.338
15	COM4	Professional/Technical/Business Services	0.007	0.033	0.164	0.329
16	COM5	Banks/Financial Institutions	0.007	0.034	0.172	0.345
17	COM6	Hospital	0.008	0.035	0.174	0.347
18	COM7	Medical Office/Clinic	0.007	0.034	0.172	0.344
19	COM8	Entertainment & Recreation	0.007	0.036	0.178	0.356
20	COM9	Theaters	0.007	0.035	0.176	0.351
21	COM10	Parking	0.004	0.017	0.087	0.174
22	IND1	Heavy	0.002	0.012	0.059	0.118
23	IND2	Light	0.002	0.012	0.059	0.118
24	IND3	Food/Drugs/Chemicals	0.002	0.012	0.059	0.118
25	IND4	Metals/Minerals Processing	0.002	0.012	0.059	0.118
26	IND5	High Technology	0.002	0.012	0.059	0.118
27	IND6	Construction	0.002	0.012	0.059	0.118
28	AGR1	Agriculture	0.000	0.008	0.038	0.077
29	REL1	Church/Membership Organization	0.008	0.033	0.163	0.326
30	GOV1	General Services	0.007	0.033	0.164	0.328
31	GOV2	Emergency Response	0.007	0.034	0.171	0.342
32	EDU1	Schools/Libraries	0.009	0.049	0.243	0.487
33	EDU2	Colleges/Universities	0.012	0.060	0.300	0.600

**Table A-16:** Nonstructural acceleration-sensitive repair costs as a fraction for building replacement cost  
new,  $L_d$ ,  $n_a$ .

No.	Label	Occupancy Class	1. Slight	2. Mod	3. Ext	4. Com
1	RES1	Single-Family Dwelling	0.005	0.027	0.080	0.266
2	RES2	Mobile Home	0.008	0.038	0.113	0.378
3-8	RES3a-f	Multi-Family Dwelling	0.008	0.043	0.131	0.437
9	RES4	Temporary Lodging	0.009	0.043	0.130	0.432
10	RES5	Institutional Dormitory	0.008	0.041	0.124	0.412
11	RES6	Nursing Home	0.008	0.041	0.122	0.408
12	COM1	Retail Trade	0.008	0.044	0.129	0.431
13	COM2	Wholesale Trade	0.008	0.042	0.124	0.411
14	COM3	Personal and Repair Services	0.010	0.050	0.150	0.500
15	COM4	Professional/Technical/Business Services	0.009	0.048	0.144	0.479
16	COM5	Banks/Financial Institutions	0.010	0.052	0.155	0.517
17	COM6	Hospital	0.010	0.051	0.154	0.513
18	COM7	Medical Office/Clinic	0.010	0.052	0.153	0.512
19	COM8	Entertainment & Recreation	0.011	0.054	0.163	0.544
20	COM9	Theaters	0.010	0.053	0.158	0.527
21	COM10	Parking	0.003	0.022	0.065	0.217
22	IND1	Heavy	0.014	0.072	0.218	0.725
23	IND2	Light	0.014	0.072	0.218	0.725
24	IND3	Food/Drugs/Chemicals	0.014	0.072	0.218	0.725
25	IND4	Metals/Minerals Processing	0.014	0.072	0.218	0.725
26	IND5	High Technology	0.014	0.072	0.218	0.725
27	IND6	Construction	0.014	0.072	0.218	0.725
28	AGR1	Agriculture	0.008	0.046	0.138	0.461
29	REL1	Church/Membership Organization	0.009	0.047	0.143	0.476
30	GOV1	General Services	0.010	0.049	0.148	0.493
31	GOV2	Emergency Response	0.010	0.051	0.151	0.505
32	EDU1	Schools/Libraries	0.007	0.032	0.097	0.324
33	EDU2	Colleges/Universities	0.006	0.029	0.087	0.290

## K.6. CALCULATE CONTENT REPAIR COST AS A FRACTION OF CONTENT REPLACEMENT COST

Content loss,  $L_c$ , is estimated solely as a function of nonstructural acceleration-sensitive damage, as in Equation A-24. See Table A-7-17 (adapted from Federal Emergency Management Agency 2012e) for values of the parameter  $L_{d,c}$ , which does not vary by occupancy class. The probability  $P[D_{na} = d | S_a = y]$  is the same as in Equation A-23. Repeat for each combination of model building type (except the obsolete ones),  $C_s$  level and  $I_e$  level.

$$L_c = \sum_{d=1}^4 P[D_{na} = d | S_a = y] L_{d,c}$$

Equation A-24

Table A-7-17: Content damage factors conditioned on acceleration-sensitive damage states.

	Acceleration sensitive nonstructural damage state			
	Slight	Moderate	Extensive	Complete
	$L_{1,c}$	$L_{2,c}$	$L_{3,c}$	$L_{4,c}$
All occupancies	0.01	0.05	0.25	0.50

## K.7. CALCULATE INJURED OCCUPANTS AS A FRACTION OF ALL INDOOR OCCUPANTS

Injuries are estimated solely as a function of structural damage. Hazus recognizes four injury severity levels, from slight to fatal; see the definitions copied in Table A-18. Injured Occupants,  $L_i$ , are denoted by  $i1$ ,  $i2$ ,  $i3$ , and  $i4$ . Equation A-25 expresses the fraction of occupants in injury severity levels  $i1$ ,  $i2$ ,  $i3$ , and  $i4$ . The probabilities  $P[D_s = d | S_d = x]$  are the same ones from Equation A-20. See Federal Emergency Management Agency (2012e) Tables 13.3 through 13.7 for values of  $L_{d,i1}$  through  $L_{d,i4}$ ; note that in these variables,  $d$  is a parameter that can take on the values 1, 2, 3, 4, and 5, so there are five values of  $L_{d,i1}$ , five of  $L_{d,i2}$ , etc., for a total of 20. One calculates  $L_{i1}$ ,  $L_{i2}$ ,  $L_{i3}$ , and  $L_{i4}$  for each point on the capacity curve. Repeat for each combination of model building type (except the obsolete ones),  $C_s$  level and  $I_e$  level.



$$L_{i1} = \sum_{d=1}^5 P[D_s = d | S_d = x] L_{d,i1}$$

$$L_{i2} = \sum_{d=1}^5 P[D_s = d | S_d = x] L_{d,i2}$$

$$L_{i3} = \sum_{d=1}^5 P[D_s = d | S_d = x] L_{d,i3}$$

$$L_{i4} = \sum_{d=1}^5 P[D_s = d | S_d = x] L_{d,i4}$$

Equation A-25

Table A-18: The injury severity levels in Hazus.

Injury Severity Level	Injury Description
Severity 1	Injuries requiring basic medical aid that could be administered by paraprofessionals. These types of injuries would require bandages or observation. Some examples are: a sprain, a severe cut requiring stitches, a minor burn (first degree or second degree on a small part of the body), or a bump on the head without loss of consciousness. Injuries of lesser severity that could be self treated are not estimated by Hazus.
Severity 2	Injuries requiring a greater degree of medical care and use of medical technology such as x-rays or surgery, but not expected to progress to a life threatening status. Some examples are third degree burns or second degree burns over large parts of the body, a bump on the head that causes loss of consciousness, fractured bone, dehydration or exposure.
Severity 3	Injuries that pose an immediate life threatening condition if not treated adequately and expeditiously. Some examples are: uncontrolled bleeding, punctured organ, other internal injuries, spinal column injuries, or crush syndrome.
Severity 4	Instantaneously killed or mortally injured

## K.8. CALCULATE LOSS OF FUNCTION DURATION

Duration of loss of function (recovery time in Hazus terminology) is also estimated solely as a function of structural damage and occupancy class. The expected value of building recovery time  $L_t$ , in days is given by Equation A-26. In this equation, the probabilities  $P[D_s = d | S_d = x]$  are the same as in Equation A-20. In the equation,  $L_{d,t}$  denotes the duration of loss of function for structural damage state  $d$ . It varies by occupancy class. See Federal Emergency Management Agency (2012e) Table 15.10 for building recovery time by damage state and occupancy class. Note that the loss of function duration for collapse ( $D_s = 5$ ) is the same as for complete structural damage, so  $L_{5t}$  is taken as the value of  $L_{4t}$ , hence the second summand postmultiplies the collapse probability by  $L_{4t}$ .

$$L_t = \sum_{d=1}^4 P[D_s = d | S_d = x] L_{d,t} + P[D_s = 5 | S_d = x] L_{4,t}$$

Equation A-26

Repeat the calculation of  $L_t$  for each point on the capacity curve and for each combination of model building type (except the obsolete ones),  $C_s$  value,  $I_e$  value, and occupancy class.

## K.9. CALCULATE DIRECT, INDIRECT TIME-ELEMENT LOSSES PER OCCUPANT

Rental and BI costs vary widely. Hazus offers some very old (1994) rental and disruption costs and warns that costs vary widely geographically. Therefore, it is important to revisit these amounts by calculating direct and indirect time-element losses  $L_{BI}$ , dollars per day per occupant. For residential occupancies RES1 through RES3 and RES5, assume monthly household furniture, higher commute costs, and miscellaneous other costs of \$600/month/household, monthly house rental cost of \$1500/month/household, and 2.5 people per household per Organisation for Economic Co-operation and Development (2016), suggesting \$28/person/day. For temporary lodging (RES4), assume lost revenue and wages equal to a typical average per-night hotel cost of \$125 per day. For nursing homes (RES6), assume lost revenue and wages equal to the average daily cost of a private room in a nursing home, \$248 per day (Mullin 2013). For nonresidential occupancies, estimate output loss (direct BI loss) per day of downtime as the ratio of industry wages and earnings to number of employees, converted to dollars per day. Results are shown in Table A-19.

Table A-19: Output loss per day of downtime VBI and per-dollar indirect BI loss Q.

No.	Occupancy Class	Label	$V_{BI}$	Q
1	Single-Family Dwelling	RES1	\$ 28.00	0.470
2	Mobile Home	RES2	\$ 28.00	0.470
3	Multi-Family Dwelling	RES3a	\$ 28.00	0.470
4	Multi-Family Dwelling	RES3b	\$ 28.00	0.470
5	Multi-Family Dwelling	RES3c	\$ 28.00	0.470
6	Multi-Family Dwelling	RES3d	\$ 28.00	0.470
7	Multi-Family Dwelling	RES3e	\$ 28.00	0.470
8	Multi-Family Dwelling	RES3f	\$ 28.00	0.470
9	Temporary Lodging	RES4	\$ 125.00	0.372
10	Institutional Dormitory	RES5	\$ 28.00	0.470
11	Nursing Home	RES6	\$ 248.00	0.500
12	Retail Trade	COM1	\$ 132.28	0.037
13	Wholesale Trade	COM2	\$ 295.21	0.033

## NATURAL HAZARD MITIGATION SAVES:

No.	Occupancy Class	Label	$V_{BI}$	Q
14	Personal and Repair Services	COM3	\$ 166.77	0.374
15	Professional/Technical Services	COM4	\$ 414.93	0.016
16	Banks/Financial Institutions	COM5	\$ 411.00	0.017
17	Hospital	COM6	\$ 243.60	0.500
18	Medical Office/Clinic	COM7	\$ 237.82	0.500
19	Entertainment & Recreation	COM8	\$ 118.94	0.637
20	Theaters	COM9	\$ 118.94	0.637
21	Parking	COM10	\$ 118.94	0.374
22	Heavy	IND1	\$ 312.49	0.260
23	Light	IND2	\$ 242.04	0.438
24	Food/Drugs/Chemicals	IND3	\$ 203.04	0.064
25	Metals/Minerals Processing	IND4	\$ 233.26	0.009
26	High Technology	IND5	\$ 465.98	0.041
27	Construction	IND6	\$ 228.35	0.051
28	Agriculture	AGR1	\$ 124.43	0.095
29	Church	REL1	\$ 165.50	0.045
30	General Services	GOV1	\$ 230.28	0.045
31	Emergency Response	GOV2	\$ 230.28	0.045
32	Schools	EDU1	\$ 162.11	0.035
33	Colleges/Universities	EDU2	\$ 162.11	0.035

For indirect BI, use IO analysis to estimate the per-dollar indirect BI loss  $Q$  resulting from \$1.00 of direct BI in a given occupancy class. Calculate  $Q$  for each occupancy class by setting the output loss for that occupancy class to \$1.00 and the output losses for all the other occupancy classes to 0. For example, to calculate  $Q$  for RES3 occupancy, set the output losses for RES1, RES2, RES4, ..., EDU2 to 0, and the output loss for RES3 to 1.0. The resulting indirect BI to the entire economy can then be assigned to  $Q$  for RES3.

Thus,  $L_{BI}$ , the BI loss per occupant, can be estimated as a function of the number of days of loss of use  $L_t$ , as follows:

$$L_{BI} = V_{BI} \cdot (1 + Q) \cdot L_t$$

Equation A-27

## K.10. CALCULATE FRACTION OF RESIDENTS DISPLACED FROM THEIR HOMES

Following Federal Emergency Management Agency (2012e) Section 14.2, estimate displaced residents as the number of occupants of residences in the complete structural damage state, plus 90% of residents of multifamily dwellings in the extensive damage state. Equation A-28 expresses the  $L_{DR}$ , the fraction of residential occupants who will be displaced from their homes.

$$L_{dr} = P[D_s = 4|S_d = s] \text{ RES1 and RES2}$$

$$L_{dr} = 0.9 \cdot P[D_s = 3|S_d = s] + P[D_s = 4|S_d = s] \text{ RES3 through RES6}$$

Equation A-28

## K.11. CALCULATE COLLAPSE PROBABILITY BASED ON NUMBER OF COLLAPSED BUILDINGS, TOTAL BUILDING AREA

For building collapse, either use the Hazus methodology or a newer one suggested by Luco et al. (2007). The former would be more consistent with the foregoing analyses, but the latter is simple and has a much stronger analytical basis, e.g., Applied Technology Council (2009). Therefore, the latter is used to calculate collapse probability,  $P_{col}$ , as a fraction of the number of buildings and the number of collapsed buildings,  $N_{COL}$ , as a factor of total building area (sf).

Luco et al. (2007) and Applied Technology Council (2009) suggest that the capacity of a new building to resist collapse can be estimated as a lognormal cumulative distribution function. Porter (2015) showed that the data in Applied Technology Council (2009) imply that the median capacity  $\theta$  can be estimated as 3.47 times  $MCE_R$  shaking (e.g.,  $3.47 \times C_s \times R \times 1.5$ ), where  $R$  denotes the ASCE 7-10 response modification coefficient from ASCE 7-10 Table 12.2-1. Table A-19 maps ASCE 7-10 building types to Hazus building types and shows the relevant  $R$  factors. The table shows three values for each model building type: one each for moderately high to very high, moderate, and low seismicity regions, based on judgment of the predominant ASCE 7-10 seismic force-resisting system (from Table 12.2-1) corresponding to each FEMA model building type in each region. "Seismicity region" refers here to the predominant seismicity region in the sense of FEMA P-154. Luco et al. (2007) use a value for the standard deviation of the natural logarithm of capacity equal to  $\beta = 0.8$ . Strength and collapse capacity increases with  $I_e$ .

For low-rise buildings (1-3 stories), calculate

$$\theta_{02} = 5.20 \cdot C_s \cdot R \cdot I_e$$

Equation A-29

## NATURAL HAZARD MITIGATION SAVES:

For mid- and high-rise buildings (4+ stories)

$$\theta_{10} = 5.20 \cdot C_s \cdot R \cdot I_e$$

Equation A-30

And in both cases, use the same  $\beta = 0.8$ , so

$$P_{col} = \Phi \left( \frac{\ln(SA02/\theta_{02})}{\beta} \right)$$

Equation A-31

$$P_{col} = \Phi \left( \frac{\ln(SA10/\theta_{10})}{\beta} \right)$$

Equation A-32

- States with predominantly moderately-high (MH) to very high (VH) seismicity: AK, CA, HI, MT, NV, OR, SC, TN, UT, WA
- States with predominantly moderate seismicity: AL, AR, AZ, CO, ID, KY, MA, ME, MO, NH, NJ, NM, NY, OK, VT, WY
- States with low seismicity: all others

$P_{col}$  gives the fraction of buildings that collapse. The project team is also interested in the number of buildings that collapse. (Not the same as the Hazus estimated fraction of total square footage in the complete damage state that is assumed to be collapsed. The difference is that only a portion of the number of buildings in the complete damage state collapse, and only a portion of the area of those buildings actually collapse.) One can estimate number of collapsed buildings as a factor of total building area (sf) using:

$$N_{COL} = P_{col}/A_{avg}$$

Equation A-33

where  $A_{avg}$  denotes the average area of a single building and varies by occupancy class. One can calculate  $A_{avg}$  from the California inventory in Hazus, dividing total building area by total building count (there does not appear to be a table in the documentation showing these values). See Table A-20.

**Table A-20:** Response modification coefficients R.

MBTID	MBT	R, MH-VH seismicity	R, mod seismicity	R, low seismicity	ASCE 7-10 Table 12.2-1 seismic force-resisting system
1	W1	6.5	6.5	6.5	A15
2	W2	7	7	7	B22
3	S1L	8	4.5	3.5	C1, C3, C4
4	S1M	8	4.5	3.5	C1, C3, C4
5	S1H	8	4.5	3.5	C1, C3, C4
6	S2L	6	3.25	3.25	B2, B3, B3
7	S2M	6	3.25	3.25	B2, B3, B3
8	S2H	6	3.25	3.25	B2, B3, B3
9	S3	6	3.25	3.25	B2, B3, B3
10	S4L	7	6	6	D3, D4, D4
11	S4M	7	6	6	D3, D4, D4
12	S4H	7	6	6	D3, D4, D4
16	C1L	8	5	3	C5, C6, C7
17	C1M	8	5	3	C5, C6, C7
18	C1H	8	5	3	C5, C6, C7
19	C2L	6	5	5	B4, B5, B5
20	C2M	6	5	5	B4, B5, B5
21	C2H	6	5	5	B4, B5, B5
25	PC1	5	5	4	B8, B8, B9
26	PC2L	6	5	5	B4, B5, B5
27	PC2M	6	5	5	B4, B5, B5
28	PC2H	6	5	5	B4, B5, B5
29	RM1L	5	3.5	2	A7, A8, A9
30	RM1M	5	3.5	2	A7, A8, A9
31	RM2L	5	3.5	2	A7, A8, A9
32	RM2M	5	3.5	2	A7, A8, A9
33	RM2H	5	3.5	2	A7, A8, A9
36	MH	6.5	6.5	6.5	NIST 1995

Table A-21: Average building area  $A_{avg}$  (square feet per building) inferred from Hazus.

OCCID	OccLabel	$A_{avg}$
1	RES1	1700
2	RES2	1100
3	RES3	6500
4	RES4	31100
5	RES5	22700
6	RES6	12100
7	COM1	71400
8	COM2	27400
9	COM3	9900
10	COM4	69100
11	COM5	3800
12	COM6	33100
13	COM7	6700
14	COM8	5000
15	COM9	4900
16	COM10	23800
17	IND1	23000
18	IND2	22700
19	IND3	25100
20	IND4	14800
21	IND5	25200
22	IND6	22300
23	AGR1	16300
24	REL1	15600
25	GOV1	9800
26	GOV2	8500
27	EDU1	25500
28	EDU2	33500

## **K.12. CALCULATE FRACTION OF BUILDINGS THAT ARE RED-TAGGED, NUMBER OF RED-TAGGED BUILDINGS AS A FACTOR OF TOTAL BUILDING AREA**

Porter (2016a) shows that for every collapsed building, approximately 3.8 are red-tagged,  $N_R$ . Thus, the fraction of buildings that are red-tagged,  $P_R$ , can be estimated as:

$$P_r = 3.8 \cdot P_{col} \leq 1 - P_{col}$$

Equation A-34

The number of red-tagged buildings, as a factor of total building area in sf, can be estimated as:

$$N_R = P_r / A_{avg}$$

Equation A-35

## **K.13. CALCULATE FRACTION OF BUILDINGS THAT ARE YELLOW-TAGGED, NUMBER OF BUILDINGS THAT ARE YELLOW-TAGGED AS A FACTOR OF TOTAL BUILDING AREA**

Porter (2016a) shows that for every red-tagged building, approximately 13 are yellow-tagged,  $P_y$ .

$$P_y = 13 \cdot P_r \leq 1 - P_{col} - P_r$$

Equation A-36

And the number of yellow-tagged buildings,  $N_Y$ , as a factor of total building area in sf, can be estimated as:

$$N_Y = P_y / A_{avg}$$

Equation A-37

## **K.14. CALCULATE PERSONS TRAPPED IN COLLAPSED BUILDINGS AS A FRACTION OF ALL INDOOR OCCUPANTS**

Porter (2016b) shows that on average, 25% of the area of buildings with at least some collapse actually experiences collapse, and estimates that 1 in 3 people occupying the collapsed area are trapped, not



fatally injured, and need extrication. Thus, the number of trapped people in collapsed buildings,  $L_{tc}$ , requiring extrication, as a fraction of total indoor occupants, can be estimated by:

$$L_{tc} = 0.083 \cdot P_{col}$$

Equation A-38

### K.15. TABULATING VULNERABILITY FUNCTIONS

At this point, the analyst has calculated each of the following quantities for each combination of  $S_d$ , model building type (except obsolete ones),  $C_s$ ,  $I_e$ , and occupancy class. (Others are calculated along the way, but these are the ones that matter for later).

Ground-motion-severity measures:

SA02: soil-amplified 5% damped spectral acceleration response at 0.2 sec period

SA10: soil-amplified 5% damped spectral acceleration response at 1.0 sec period

Loss measures:

$L_b$ : mean building repair cost as a fraction of its replacement cost new

$L_c$ : mean content repair cost as a fraction of its replacement cost new

$L_{i1}$ : mean fraction of indoor occupants in injury severity level 1

$L_{i2}$ : mean fraction of indoor occupants in injury severity level 2

$L_{i3}$ : mean fraction of indoor occupants in injury severity level 3

$L_{i4}$ : mean fraction of indoor occupants in injury severity level 4

$L_f$ : mean duration of loss of function, in days

$L_{BI}$ : mean business interruption loss per occupant per day, \$

$L_{dr}$ : mean fraction of residential occupants displaced from their homes

$P_{col}$ : fraction of buildings that collapse

$N_{COL}$ : number of collapsed buildings, as a factor of total building area (sf)

$P_r$ : fraction of building that are red-tagged

$N_R$ : number of red-tagged buildings, as a factor of total building area (sf)

$P_y$ : fraction of building that are yellow-tagged

$N_Y$ : number of yellow-tagged buildings, as a factor of total building area (sf)

$N_{tc}$ : fraction of indoor occupants trapped in collapsed buildings

Recall that all of these quantities have been calculated for each of 51 points on the capacity curve, which were parameterized by pairs  $(S_d, S_a)$ . One can then relate a value of SA02 to each loss measure, and construct a one-to-one pairing, creating a set of vulnerability and fragility functions that relate 5%-damped short-period spectral acceleration response SA02 to each measure. One can also create similar fragility and vulnerability functions in terms of 5%-damped 1.0-second spectral acceleration response, SA10.

## NATURAL HAZARD MITIGATION SAVES:

Because of how one calculates the ground-motion-severity measures SA02 and SA10 from  $S_d$ , they are not the same 51 values for each combination of model building type,  $C_s$ ,  $I_e$ , and occupancy class. It will be more convenient later to have losses tabulated at a consistent set of ground-motion-severity levels, so for each combination of 28 non-obsolete model building types, 28 occupancy classes, 31  $C_s$  levels, and 10  $I_e$  levels, one can linearly interpolate at 401 ground-motion input levels  $SA02 = \{0.00g, 0.01g, 0.02g, \dots, 4g\}$  and again at 401 values of  $SA10 = \{0.00g, 0.01g, 0.02g, \dots, 4.00g\}$ . Thus, at the end of this step, there are two very large tables ( $28 \times 28 \times 31 \times 10 \times 401 = 97.5$  million records) containing the seismic vulnerability functions, with the fields listed in Box K-1 (functions in terms of 5%-damped short-period spectral acceleration response SA02) and Box K-2 (functions in terms of 5%-damped 1-second spectral acceleration response, SA10).

**Box K-1. Vulnerability Functions in Terms of 5% Damped Short-Period Spectral Acceleration**

MBTID: an integer index 1, 2, ... 36 corresponding to model building types (only 28 used)

OCCID: an integer index 1, 2, ... 28 corresponding to occupancy classes

CSID: an integer index 1, 2, ... 31 corresponding to a  $C_s$  value

IEID: an integer index 1, 2, ... 10 corresponding to an  $I_e$  value

SA02ID: an integer index 0, 1, 2, ... 400 corresponding to a value of SA02

Model building type: one of {W1, W2, ... MH}; omitting obsolete types, 28 types

Occupancy class: one of {RES1, RES2, RES3, ... EDU2}, 28 classes

$C_s$ : one of  $\{10^{-2}, 10^{-1.9}, \dots, 10^1\}$ , units of gravity, 31 values

$I_e$ : one of  $\{1, 1.25, 1.5, 2, 3, 4, 5, 6, 7, 8\}$  for above-code design,  $\{1.0, 0.67, 0.44, 0.30\}$  for below-code design

SA02: one of  $x = \{0.00, 0.01, 0.02, \dots, 4.00\}$ , units of gravity, 401 values

$y_b(x)$  = mean building repair cost as a fraction of its replacement cost new given SA02 = x

$y_c(x)$  = mean content repair cost as a fraction of its replacement cost new given SA02 = x

$y_{i1}(x)$  = mean fraction of indoor occupants in injury severity level 1 given SA02 = x

$y_{i2}(x)$  = mean fraction of indoor occupants in injury severity level 2 given SA02 = x

$y_{i3}(x)$  = mean fraction of indoor occupants in injury severity level 3 given SA02 = x

$y_{i4}(x)$  = mean fraction of indoor occupants in injury severity level 4 given SA02 = x

$y_T(x)$  = mean duration of loss of function, in days, given SA02 = x

$y_{BI}(x)$  = mean business interruption loss per occupant per day, \$, given SA02 = x

$y_{dr}(x)$  = mean fraction of residential occupants displaced from their homes given SA02 = x

$y_{col}(x)$  = fraction of buildings that collapse, given SA02 = x

$y_{COL}(x)$  = number of collapsed buildings, as a factor of total building area (sf), given SA02 = x

$y_r(x)$  = fraction of buildings that are red-tagged, given SA02 = x

$y_R(x)$  = number of red-tagged buildings, as a factor of total building area (sf), given SA02 = x

$y_y(x)$  = fraction of building that are yellow-tagged, given SA02 = x

$y_Y(x)$  = number of yellow-tagged buildings, as factor of total building area (sf), given SA02 = x

$y_{tc}(x)$  = fraction of indoor occupants trapped in collapsed buildings, given SA02 = x

**Box K-2. Vulnerability Functions in Terms of 5% Damped 1-Sec Spectral Acceleration SA10**

MBTID: an integer index 1, 2, ... 36 corresponding to model building types (only 28 used)

OCCID: an integer index 1, 2, ... 28 corresponding to occupancy classes

CSID: an integer index 1, 2, ... 31 corresponding to a  $C_s$  value

IEID: an integer index 1, 2, ... 10 corresponding to an  $I_e$  value

SA10ID: an integer index 0, 1, 2, ... 400 corresponding to a value of SA10

Model building type: one of {W1, W2, ... MH}; omitting obsolete types, 28 types

Occupancy class: one of {RES1, RES2, RES3, ... EDU2}, 28 classes

$C_s$ : one of  $\{10^{-2}, 10^{-1.9}, \dots 10^1\}$ , units of gravity, 31 values

$I_e$ : one of  $\{1, 1.25, 1.5, 2, 3, 4, 5, 6, 7, 8\}$  for above-code design,  $\{1.0, 0.67, 0.44, 0.30\}$  for below-code design

SA10: one of  $\{0.00, 0.01, 0.02, \dots 4.00\}$ , units of gravity, 401 values

$y_b(x)$  = mean building repair cost as a fraction of its replacement cost new given SA10 = x

$y_c(x)$  = mean content repair cost as a fraction of its replacement cost new given SA10 = x

$y_{i1}(x)$  = mean fraction of indoor occupants in injury severity level 1 given SA10 = x

$y_{i2}(x)$  = mean fraction of indoor occupants in injury severity level 2 given SA10 = x

$y_{i3}(x)$  = mean fraction of indoor occupants in injury severity level 3 given SA10 = x

$y_{i4}(x)$  = mean fraction of indoor occupants in injury severity level 4 given SA10 = x

$y_T(x)$  = mean duration of loss of function, in days, given SA10 = x

$y_{BI}(x)$  = mean business interruption loss per occupant per day, \$, given SA10 = x

$y_{dr}(x)$  = mean fraction of residential occupants displaced from their homes given SA10 = x

$y_{col}(x)$  = fraction of buildings that collapse, given SA10 = x

$y_{COL}(x)$  = number of collapsed buildings, as a factor of total building area (sf), given SA10 = x

$y_r(x)$  = fraction of buildings that are red-tagged, given SA10 = x

$y_R(x)$  = number of red-tagged buildings, as a factor of total building area (sf), given SA10 = x

$y_y(x)$  = fraction of building that are yellow-tagged, given SA10 = x

$y_Y(x)$  = number of yellow-tagged buildings as factor of total building area (sf), given SA10 = x

$y_{tc}(x)$  = fraction of indoor occupants trapped in collapsed buildings, given SA10 = x

## K.16. STATEWIDE WEIGHTED-AVERAGE VULNERABILITY FUNCTIONS

The project team wanted to express benefits and costs for design above code, without generating countless combinations of building type and occupancy class. Therefore, the team estimated BCRs for a weighted average of the building types common in each state, with weights that reflect that state's recent construction practice.

## NATURAL HAZARD MITIGATION SAVES:

Use the Hazus inventory of buildings with the highest design level as weights. That is, for states with high-code buildings, weight vulnerability functions by the total estimated statewide building area of high-code buildings for each model building type and occupancy class. For states with no high-code buildings, use the statewide total building area of moderate-code buildings as weights. In both cases, the weights are normalized so they add to 1.0.

Consider two averaging schemes: one that averages all types together, and one that distinguishes between residential and nonresidential construction. Thus, weights for the residential weighted average vulnerability functions use as weights the total square footage by model building type and occupancy class, but with zero weight for all nonresidential occupancy classes. Likewise,

### **Box K-3. Statewide Vulnerability Functions in Terms of 5% Damped Short-Period Spectral Acceleration SA02**

MBTID: an integer 1xx, where xx denotes the state's U.S. Federal Information Processing Standard (FIPS) numeric code, as specified in FIPS Publication "FIPS PUB" 5-2 (<https://catalog.data.gov/dataset/fips-state-codes>)

OCCID: an integer index 100 to indicate all residential occupancies, 200 to indicate all nonresidential occupancies, or 0 to indicate all occupancy classes

CSID: an integer index 1, 2, ... 31 corresponding to a  $C_s$  value

IEID: an integer index 1, 2, ... 10 corresponding to an  $I_e$  value

SA02ID: an integer index 0, 1, 2, ... 400 corresponding to a value of SA02

Model building type: XX, where XX is the FIPS state alpha (same as postal) code as specified in FIPS PUB 5-2

Occupancy class: one of {RES, NRES, AVG}, indicating average of all residential occupancies, nonresidential occupancies, or all occupancies, 3 classes

$C_s$ : one of  $\{10^{-2}, 10^{-1.9}, \dots, 10^1\}$ , units of gravity, 31 values

$I_e$ : one of  $\{1, 1.25, 1.5, 2, 3, 4, 5, 6, 7, 8\}$  for above-code design,  $\{1.0, 0.67, 0.44, 0.30\}$  for below-code design

SA02: one of  $\{0.00, 0.01, 0.02, \dots, 4.00\}$ , units of gravity, 401 values

$y_b(x)$  = mean building repair cost as a fraction of its replacement cost new given SA02 = x

...

(same as Box K-1)

...

$y_{tc}(x)$  = fraction of indoor occupants trapped in collapsed buildings, given SA02 = x

weights for the nonresidential weighted average vulnerability functions use as weights the total square footage by model building type and occupancy class, but with zero weight for all residential occupancy classes.

Using the vulnerability functions listed in Appendix M, create a set of residential vulnerability functions, nonresidential vulnerability functions, and overall average vulnerability functions, one for each state. Thus, at the end of this step, there are two very large tables ( $50 \times 3 \times 31 \times 10 \times 401 = 18,646,500$  records) containing seismic vulnerability functions, with the fields listed in Box K-3 and Box K-4.

### **K.17.      NATIONWIDE WEIGHTED-AVERAGE VULNERABILITY FUNCTIONS**

Create a single set of weighted-average vulnerability functions, using total building areas from all states as weights. As before, to reflect recent trends in construction, weights only consider high-code building areas for states with high-code construction, moderate-code building areas for states without high-code construction, and low-code building areas for states without high or moderate-code construction. These are like those shown in Box K-3 and K-4 except:

MBTID: an integer 1,000, to indicate a nationwide average

Model building type: "U.S."

**Box K-4. Statewide Vulnerability Functions in Terms of 5% Damped 1-Sec Spectral Acceleration**

MBTID: an integer 1xx, where xx denotes the state FIPS numeric code, as specified in “FIPS PUB” 5-2 (<https://catalog.data.gov/dataset/fips-state-codes>)

OCCID: an integer index 100 to indicate all residential occupancies, 200 to indicate all nonresidential occupancies, or 0 to indicate all occupancy classes

CSID: an integer index 1, 2, ... 31 corresponding to a  $C_s$  value

IEID: an integer index 1, 2, ... 10 corresponding to an  $I_e$  value

SA10ID: an integer index 0, 1, 2, ... 400 corresponding to a value of SA10

Model building type: XX, where XX is the FIPS state alpha (same as postal) code as specified in FIPS PUB 5-2

Occupancy class: one of {RES, NRES, AVG}, indicating average of all residential occupancies, nonresidential occupancies, or all occupancies, 3 classes

$C_s$ : one of  $\{10^{-2}, 10^{-1.9}, \dots, 10^1\}$ , units of gravity, 31 values

$I_e$ : one of  $\{1, 1.25, 1.5, 2, 3, 4, 5, 6, 7, 8\}$  for above-code design,  $\{1.0, 0.67, 0.44, 0.30\}$  for below-code design

SA10: one of  $\{0.00, 0.01, 0.02, \dots, 4.00\}$ , units of gravity, 401 values

$y_b(x)$  = mean building repair cost as a fraction of its replacement cost new given SA10 = x

...

(same as Box K-2)

...

$y_{tc}(x)$  = fraction of indoor occupants trapped in collapsed buildings, given SA10 = x

**K.18. UNCERTAINTY DOES NOT MATTER TO BCR**

In Porter (2010), a method is proposed to model the uncertainty in loss when its expected value is calculated by the Hazus approach, but in the present case one does not need to calculate uncertainty. The EAL is solely a function of the expected value of loss at any level of excitation and the frequency with which that level of excitation is exceeded, as shown in Equation 4-1. That may seem counterintuitive. Recall, however, that EAL is the expected value of a sum of uncertain summands. The expected value of a sum equals the sum of the expected values of the summands. Put another way, the expected value operator  $E[*]$  is a linear operator, in the sense that

$$\begin{aligned}
 E[X + c] &= E[X] + c \\
 E[X + Y] &= E[X] + E[Y] \\
 E[aX] &= aE[X]
 \end{aligned}$$

where  $a$  and  $c$  are constants,  $X$  and  $Y$  are uncertain, and  $X$  need not be statistically independent of  $Y$ .

## K.19. CALCULATING BCR AT THE CENSUS-TRACT, COUNTY, STATE, AND NATIONAL LEVEL

The project team has extracted from Hazus a nationwide inventory of buildings, as discussed elsewhere in the Interim Study. The inventory estimates the stock of existing buildings, but one can extrapolate to new construction by recognizing that approximately 1% of the current building stock is replaced every year. Therefore, the benefits and costs of design are calculated to exceed I-Code requirements for 1% of the current building stock, which is the annual benefit and annual cost of designing to exceed I-Code requirements. The ratio of the benefit and cost is the BCR for exceeding I-Code requirements. The following defines the necessary parameters of hazard, vulnerability, and exposed value:

Hazard, from USGS National Seismic Hazard Maps

$x$  = a particular value of SA02

$G(x)$  = mean frequency (events per year) of earthquakes causing shaking SA02  $\geq x$ , by census tract

Vulnerability from Box K-3, from Sec K.1.15, by state,  $I_e$  value, and aggregate occupancy (RES or NRES)

$A$  = total building area, 1,000 sf, in a particular census tract and aggregate occupancy class (RES and NRES), as of some basis year, in the project team's case, 2002.

$V_b$  = total replacement cost new of buildings in a census tract, by aggregate occupancy and basis year, \$1,000s

$V_c$  = total replacement cost new of contents in a census tract, by aggregate occupancy class, and year, \$1,000s

$N_{occ2PM}$  = total number of indoor occupants at 2 PM, by tract, aggregate occupancy class, etc., as of the basis year (2002)

$N_{occ2AM}$  = number of indoor occupants at 2 AM, by tract, aggregate occupancy class, etc., as of the basis year (2002)

$N_{occ5PM}$  = number of indoor occupants at 5 PM, by tract, aggregate occupancy class, etc., as of the basis year (2002)

$N_{occ}$  = time-average number of indoor occupants, by tract, aggregate occupancy class, etc., as of the basis year (2002)



## NATURAL HAZARD MITIGATION SAVES:

$$N_{occ} = \frac{40}{168} N_{occ2PM} + \frac{98}{168} N_{occ2AM} + \frac{30}{168} N_{occ5PM}$$

Equation A-39

$I_A$  = estimated 2016 building area as a factor of building area in 2002 = 1.089, based on the ratio of U.S. population in the two years = 324,100,000/297,600,000

$I_B$  = estimated 2016 square-foot construction cost as a factor of basis-year  $V_b$ , based on the ratio of RSMean's 30-city average historical cost indices in 2016 and 2002, respectively = 1.61

$V_{i1}$  = acceptable cost to avoid Hazus injury severity level 1 = \$53,000

$V_{i2}$  = acceptable cost to avoid Hazus injury severity level 2 = \$550,000

$V_{i3}$  = acceptable cost to avoid Hazus injury severity level 3 = \$3,700,000

$V_{i4}$  = acceptable cost to avoid Hazus injury severity level 4 = \$9,500,000

$V_{CRY}$  = acceptable cost to avoid collapse, red-tagging, or yellow-tagging. The project team cannot find sufficient evidence to assign a particular value to this parameter. This assumes that other calculations of loss associated with PTSD cover the emotional trauma associated with the sudden impairment of a home, and therefore assign  $V_{CRY} = \$0$ .

$V_{usar}$  = urban search and rescue cost to extricate 1 trapped victim = \$10,000. It is based on 100 person-hours x \$100/hr. The first figure is based on an estimated 2,000 person-hours expended in urban search and rescue efforts at the Northridge Meadows Apartment Buildings in the 1994 Northridge Earthquake, which extricated 20 people (<https://goo.gl/C5CST6>). The second figure is based on the annual budget of the Los Angeles Fire Department (approximately \$630 million) divided by the number of uniformed firefighters (approximately 3200) divided by 2000 work hours per person per year.

$g$  = population growth rate, U.S. average = 0.007 per year (World Bank 2017)

$r$  = discount rate for private-sector or public-sector borrowing, less inflation. See Appendix H for discussion on values used.

$t$  = duration over which benefits will be recognized. The half-life of a new building is probably on the order of 100 years, but the *2005 Mitigation Saves* study recognized benefits only for 50 years in ordinary buildings. This uses an intermediate value of  $t = 75$  years.

One then calculates, for each census tract and each aggregate occupancy (RES and NRES), the sum of  $A$ ,  $V_b$ ,  $V_G$ ,  $N_{occ2AM}$ ,  $N_{occ2PM}$ ,  $N_{occ5PM}$ . Then calculate the following annualized damage and loss values for each set of  $I_e$  vulnerability functions. Use the vulnerability functions for the value of ASCE 7-10's  $C_s$  appropriate

## NATURAL HAZARD MITIGATION SAVES:

to each census tract, calculated as  $2/3 \times S_{MS}/R$ , where R is taken as 6.4, based on a building-value-weighted average for high-code (recent) California construction.

County (5-digit FIPS code, e.g., 06001 = Alameda County, CA)

Aggregated occupancy class (RES or NRES)

$A$  = total building area, 1,000 sf, in a particular census tract and aggregate occupancy class (RES and NRES), as of some basis year, in the project team's case, 2002.

$V_b$  = total replacement cost new of buildings in a census tract, by aggregate occupancy and basis year, \$1,000s

$V_c$  = total replacement cost new of contents in a census tract, by aggregate occupancy class, and year, \$1,000s

$N_{occ2PM}$  = total number of indoor occupants at 2 PM, by tract, aggregate occupancy class, etc., as of the basis year (2002)

$N_{occ2AM}$  = number of indoor occupants at 2 AM, by tract, aggregate occupancy class, etc., as of the basis year (2002)

$N_{occ5PM}$  = number of indoor occupants at 5 PM, by tract, aggregate occupancy class, etc., as of the basis year (2002)

$N_{occ}$  = time-average number of indoor occupants, by tract, aggregate occupancy class, etc., as of the basis year (2002)

$EAD_b$  = expected annualized damage factor for building repairs, e.g., the expected value of the annual cost to repair new buildings, as a fraction of replacement cost new. (Note that this equation involves a proper integral that is actually evaluated numerically. The same form is used in many of the following equations. See Equation A-63 for the numerical method.)

$$EAD_b = \int_{x=0}^{\infty} y_b(x) \left| \frac{dG(x)}{dx} \right| dx$$

Equation A-40

$EAN_{i1}$  = expected annualized number of people in new buildings in Hazus injury severity 1. The factor  $I_A$  accounts for population growth. The factor 0.01 accounts for the fact that 1% of the existing building stock is added in a year.  $N_{occ}$  is number of people in 2002.

## NATURAL HAZARD MITIGATION SAVES:

$$EAN_{i1} = I_A \cdot N_{occ} \cdot 0.01 \int_{x=0}^{\infty} y_{i1}(x) \left| \frac{dG(x)}{dx} \right| dx$$

Equation A-41

$EAN_{i2}$  = expected annualized number of people in new buildings in Hazus injury severity 2

$$EAN_{i2} = I_A \cdot N_{occ} \cdot 0.01 \cdot \int_{x=0}^{\infty} y_{i2}(x) \left| \frac{dG(x)}{dx} \right| dx$$

Equation A-42

$EAN_{i3}$  = expected annualized number of people in new buildings in Hazus injury severity 3

$$EAN_{i3} = I_A \cdot N_{occ} \cdot 0.01 \int_{x=0}^{\infty} y_{i3}(x) \left| \frac{dG(x)}{dx} \right| dx$$

Equation A-43

$EAN_{i4}$  = expected annualized number of people in new buildings in Hazus injury severity 4

$$EAN_{i4} = I_A \cdot N_{occ} \cdot 0.01 \cdot \int_{x=0}^{\infty} y_{i4}(x) \left| \frac{dG(x)}{dx} \right| dx$$

Equation A-44

$EAD_T$  = expected annualized number of days required to restore new buildings to functionality

$$EAD_T = \int_{x=0}^{\infty} y_T(x) \left| \frac{dG(x)}{dx} \right| dx$$

Equation A-45

$EAN_{dr}$  = expected annualized number of displaced households (RES only). The factor  $I_A$  accounts for population growth.

$$EAN_{dr} = I_A \cdot N_{occ2AM} \cdot \int_{x=0}^{\infty} y_T(x) \left| \frac{dG(x)}{dx} \right| dx$$

Equation A-46

$EAD_{col}$  = expected annualized fraction of new buildings experiencing collapse

$$EAD_{col} = \int_{x=0}^{\infty} y_{col}(x) \left| \frac{dG(x)}{dx} \right| dx$$

Equation A-47

$EAN_{col}$  = expected annualized number of new buildings experiencing collapse. In the following equation, the factor of 1,000 accounts for the fact that  $A$  is expressed in 1,000 sf. The factor of 0.01 accounts for the annual growth in the building stock.

$$EAN_{col} = I_A \cdot A \cdot 1000 \cdot 0.01 \cdot \int_{x=0}^{\infty} y_{col}(x) \left| \frac{dG(x)}{dx} \right| dx$$

Equation A-48

$EAD_r$  = expected annualized fraction of new buildings that are red-tagged

$$EAD_r = \int_{x=0}^{\infty} y_r(x) \left| \frac{dG(x)}{dx} \right| dx$$

Equation A-49

$EAN_r$  = expected annualized number of new buildings that are red-tagged

$$EAN_r = I_A \cdot A \cdot 1000 \cdot 0.01 \cdot \int_{x=0}^{\infty} y_r(x) \left| \frac{dG(x)}{dx} \right| dx$$

Equation A-50

$EAD_y$  = expected annualized fraction of new buildings that are yellow-tagged

$$EAD_y = \int_{x=0}^{\infty} y_y(x) \left| \frac{dG(x)}{dx} \right| dx$$

Equation A-51

$EAN_y$  = expected annualized number of new buildings that are yellow-tagged

$$EAN_y = I_A \cdot A \cdot 1000 \cdot 0.01 \cdot \int_{x=0}^{\infty} y_y(x) \left| \frac{dG(x)}{dx} \right| dx$$

Equation A-52

## NATURAL HAZARD MITIGATION SAVES:

$EAN_{tc}$  = expected annualized number of occupants of new buildings who are trapped in collapsed buildings

$$EAN_{tc} = I_A \cdot N_{occ} \cdot 0.01 \cdot \int_{x=0}^{\infty} y_{tc}(x) \left| \frac{dG(x)}{dx} \right| dx$$

Equation A-53

This then tabulates monetary losses in annualized terms:

$EAL_b$  = expected annualized building repair cost of new buildings (all expressions for EAL are in 2016 USD). The factor of 0.01 is to account for the fact that only 1% of the building stock is replaced annually. The factor of 1,000 accounts for the fact that  $V_c$  is expressed in \$1,000s.

$$EAL_b = EAD_b \cdot I_A \cdot I_B \cdot V_b \cdot 0.01 \cdot 1000$$

Equation A-54

$EAL_c$  = expected annualized content repair cost in new buildings

$$EAL_c = I_A \cdot I_B \cdot V_c \cdot 0.01 \cdot 1000 \cdot \int_{x=0}^{\infty} y_c(x) \left| \frac{dG(x)}{dx} \right| dx$$

Equation A-55

$EAL_{tc}$  = expected annualized cost of urban search and rescue efforts.

$$EAL_{tc} = V_{usar} \cdot (EAN_{tc} + EAN_{i4})$$

Equation A-56

$EAL_{BI}$  = expected annualized loss associated with loss of function, both direct and indirect. The factor  $I_A$  adjusts the occupant loads  $N_{occ}$  from 2002 to 2017 values. The factor 0.01 accounts for the fact that 1% of the building stock is added or replaced annually.  $EAD_T$  is the average annual number of days that new buildings are unavailable.  $V_{BI}$  is the estimated output loss (the additional living expense or direct BI loss) in 2017 USD associated with one day's loss of use. The factor  $R_2$  is a multiplier for indirect BI: it is the indirect BI loss calculated using input-output analysis resulting from \$1.00 of direct BI.  $V_{BI}$  and  $R_2$  vary by occupancy type and are shown in Table A-19.

$$EAL_{BI} = I_A \cdot \max(N_{occ2AM}, N_{occ2PM}) \cdot 0.01 \cdot EAD_T \cdot V_{BI} \cdot (1 + Q)$$

Equation A-57

## NATURAL HAZARD MITIGATION SAVES:

Now calculate acceptable costs to avoid statistical human injuries in expected annualized terms.

$EAL_{i1}$  = expected annualized value of avoiding statistical Hazus severity 1 injuries

$$EAL_{i1} = EAN_{i1} \cdot V_{i1}$$

Equation A-58

$EAL_{i2}$  = expected annualized value of avoiding statistical Hazus severity 2 injuries

$$EAL_{i2} = EAN_{i2} \cdot V_{i2}$$

Equation A-59

$EAL_{i3}$  = expected annualized value of avoiding statistical Hazus severity 3 injuries

$$EAL_{i3} = EAN_{i3} \cdot V_{i3}$$

Equation A-60

$EAL_{i4}$  = expected annualized value of avoiding statistical Hazus severity 4 injuries

$$EAL_{i4} = EAN_{i4} \cdot V_{i4}$$

Equation A-61

$EAL_{PTSD}$  = expected annualized loss associated with PTSD, estimated as shown in Equation A-62, where  $V_{PTSD} = \$90,000$

$$EAL_{PTSD} = V_{PTSD} \cdot EAN_{i2}$$

Equation A-62

Several of these equations contain an integral of the form

$$I = \int_0^{\infty} y(x) \left| \frac{dG(x)}{dx} \right| dx$$

Equation A-63

Equation A-63 is only rarely solvable in closed form. More commonly,  $y(x)$  and  $G(x)$  are available at discrete values of  $x$ . If one has  $n + 1$  values of  $x$ , at which both  $y(x)$  and  $G(x)$  are available, and these are denoted by  $x_i$ ,  $y_i$  and  $G_i$ ;  $i = 0, 1, 2, \dots, n$ , respectively, then  $I$  in Equation A-63 can be replaced by Equation A-64. The equation gives an exact solution when  $y(x)$  is linear between values of  $x$  and  $\ln(G(x))$  is linear between values of  $x$ :

$$I = \sum_{i=1}^n \left( y_{i-1} G_{i-1} (1 - \exp(m_i \Delta x_i)) - \frac{\Delta y_i}{\Delta x_i} G_{i-1} \left( \exp(m_i \Delta x_i) \left( \Delta x_i - \frac{1}{m_i} \right) + \frac{1}{m_i} \right) \right)$$

$$= \sum_{i=1}^n (y_{i-1} a_i - \Delta y_i b_i)$$

Equation A-64

Where,

$$\Delta x_i = x_i - x_{i-1} \quad \Delta y_i = y_i - y_{i-1} \quad m_i = \ln(G_i / G_{i-1}) / \Delta x_i \text{ for } i = 1, 2, \dots, n$$

$$a_i = G_{i-1} (1 - \exp(m_i \Delta x_i)) \quad b_i = \frac{G_{i-1}}{\Delta x_i} \left( \exp(m_i \Delta x_i) \left( \Delta x_i - \frac{1}{m_i} \right) + \frac{1}{m_i} \right)$$

Porter (2016) shows several different ways how  $I_e = 1.5$  costs approximately 1% greater construction cost than  $I_e = 1.0$ . In Equation A-65, one takes the marginal cost as proportional to the strength increase: 2% per unit of  $I_e$  above 1.0, with an additional factor of 0.01 to account for the 1% annual growth in the building stock. The benefit  $b$ , cost  $c$ , and BCR  $b/c$  of designing to exceed I-Code requirements for the given census tract, aggregate occupancy class (RES or NRES), and earthquake importance factor are given by

$$c = I_A \cdot I_B \cdot V_b \cdot 1000 \cdot 0.0002 \cdot (I_e - 1)$$

Equation A-65

$$PV_{Money} = (EAL_b + EAL_c + EAL_{BI} + EAL_{IC}) \cdot \left( \frac{(1 - \exp(-r \cdot t))}{r} \right)$$

Equation A-66

$$PV_{Injuries} = (EAL_{I1} + EAL_{I2} + EAL_{I3} + EAL_{I4} + EAL_{PTSD}) \cdot t$$

Equation A-67

$$PV = PV_{Money} + PV_{Injuries}$$

Equation A-68

$$b = PV_{I_e=1.0} - PV_{I_e>1.0}$$

Equation A-69

## NATURAL HAZARD MITIGATION SAVES:

In Equations Equation A-66 and Equation A-67, money refers to losses associated with financial consequences while injuries refers to losses associated with deaths and nonfatal injuries, including PTSD. Evaluate Equations Equation A-65 through Equation A-69 for each census tract, each aggregate occupancy class, and each value of  $l_e \in \{1.0, 1.25, 1.5, 2.0, \dots 8.0\}$ . As discussed earlier, this does not apply a discount rate to statistical injuries avoided.

### K.20. AGGREGATION TO COUNTIES

Readers of the *2019 Report* may have trouble digesting BCR information at the census-tract level. Few people know in what census tract their buildings reside. Therefore, benefits and costs are aggregated first at the county and then at the state level. Census tract numbers contain within them a code to indicate the state (the first 2 digits) and county (the next 3 digits). Thus, the first 5 digits uniquely identify a county and state. Therefore, sum benefits and costs over all tracts for each combination of:

- County FIPS code (first 5 digits of the census tract number)
- $l_e$  value, and
- Aggregate occupancy class (RES or NRES).

This assumes a fraction  $f$  of all new buildings are designed to exceed I-Code requirements, and initially take  $f$  as 1.0. Results can later be scaled by whatever fraction  $f$  seems realistic. The quantity BCR is insensitive to  $f$ .

$$B_{\text{County}} = f \cdot \sum_{\text{tracts}} b$$

Equation A-70

$$C_{\text{County}} = f \cdot \sum_{\text{tracts}} c$$

Equation A-71

$$BCR_{\text{County}} = \frac{B_{\text{County}}}{C_{\text{County}}}$$

Equation A-72

Again, evaluate Equations Equation A-68 through Equation A-70 for each value of  $z \in \{1.25, 1.5, 2.0, \dots 8.0\}$ , searching for the range of  $l_e$  (e.g., the particular values of  $z$ ) where  $BCR > 1.0$ . Note that if the same fraction of new buildings are designed to exceed I-Code requirements in each subsequent year 0, 1, 2, ...  $t - 1$ , benefits and costs will increase with population growth as in:



$$\begin{aligned}\hat{B}_{County} &= B_{County} \cdot \sum_{n=0}^{t-1} (1+p)^n \\ &= B_{County} \cdot P\end{aligned}$$

Equation A-73

$$\begin{aligned}\hat{C}_{County} &= C_{County} \cdot \sum_{n=0}^{t-1} (1+p)^n \\ &= C_{County} \cdot P\end{aligned}$$

Equation A-74

For the given values of population growth rate  $p = 0.007/\text{year}$  and  $t = 75$  years,  $P = 98.2$ . BCR remains as calculated in Equation A-72.

Thus, one evaluates Equation A-73 and Equation A-74 for each combination of county FIPS code, aggregate occupancy class (RES or NRES), and each  $l_e$  value above 1.0, e.g.,  $z \in \{1.25, 1.5, 2.0, \dots 8.0\}$ .

One also calculates total BCR by county:

$$BCR_{TOT} = \frac{B_{RES} + B_{NRES}}{C_{RES} + C_{NRES}}$$

Equation A-75

## **K.21. AGGREGATION TO STATE LEVEL**

The first two digits of the 5-digit county FIPS code uniquely identify the state, so repeat Equations Equation A-75 through Equation A-77 aggregating benefits and costs for each unique combination of 2-digit state FIPS code, aggregate occupancy class (RES or NRES), and each  $l_e$  value above 1.0, e.g.,  $z \in \{1.25, 1.5, 2.0, \dots 8.0\}$ . Also calculate statewide aggregate BCR as

$$B_{State} = \sum_{Counties} B_{County}$$

Equation A-76

$$C_{State} = \sum_{Counties} C_{County}$$

Equation A-77

$$BCR_{State} = \frac{B_{State}}{C_{State}}$$

Equation A-78

## K.22. IEMAX I<sub>E</sub> VALUE

The analyst is interested in the point of diminishing returns: the level of  $I_e$  at which an increase in  $I_e$  raises costs more than it raises benefits. This refers to that value as the IEMax  $I_e$ . Let:

$i$  = index to  $I_e$  values:  $i = 0$  refers to  $I_e = 1.0$ ,  $i = 1$  refers to  $I_e = 1.25$ ,  $i = 2$  refers to  $I_e = 1.5$ , etc.

$I_{e,i}$  =  $I_e$  value associated with index  $i$

$B_i$  = statewide benefit associated with the  $i^{\text{th}}$  value of  $I_e$ . For example,  $B_3$  denotes the statewide benefit associated with  $I_e = 2.0$ .

$C_i$  = statewide cost associated with the  $i^{\text{th}}$  value of  $I_e$ .

$$\Delta B_i = B_i - B_{i-1} \quad i > 0$$

Equation A-79

$$\Delta C_i = C_i - C_{i-1} \quad i > 0$$

Equation A-80

$$\hat{I}_e = I_{e,i} \quad \max \{i\} : \frac{\Delta B_i}{\Delta C_i} \geq 1.0$$

Equation A-81

Equation A-81 gives the IEMax value of  $I_e$ .

## K.23. SENSITIVITY TESTS

1. Discount rate = 3%

This is one of two standard discount rates used by the OMB:

$$r_{RES} = r_{NRES} = 0.03$$

2. Discount rate = 7%, the other OMB discount rate:

$$r_{RES} = r_{NRES} = 0.07$$

3. Collapse probability at  $MCE_R = 2\%$

## NATURAL HAZARD MITIGATION SAVES:

Perhaps, in contrast with the evidence in FEMA P-695 (Federal Emergency Management Agency 2009c) discussed in Porter (2015), the average collapse probability of new buildings subjected to  $MCE_R$  shaking is as low as  $P_c = 0.02$  (R. Hamburger written communication, Jun 9, 2017). The lower collapse probability at  $MCE_R$  would affect the collapse fragility function and everything that depends on collapse fragility, especially number of collapsed buildings, number of red-tagged buildings, and number of yellow-tagged buildings.

These are recalculated by changing the median collapse capacity values in Section K.1.10, then by recalculating everything that comes after. This uses the definitions of  $C_S$  and  $R$  offered in Section K.1.10, and denoted by  $\beta$  the standard deviation of the natural logarithm of collapse capacity. Luco et al. (2007) use  $\beta = 0.8$ . One can estimate the median capacities of Equations [Equation A-29](#) and [Equation A-30](#) by substituting these quantities into:

$$\theta = 1.5 \times C_S \times R \times \exp(-\Phi^{-1}(P_c) \times \beta)$$

Equation A-82

Which would imply the following alternatives to Equations [Equation A-29](#) and [Equation A-30](#):

$$\theta_{02} = 7.76 \cdot C_S \cdot R \cdot I_e \text{ for low-rise buildings (1-3 stories)}$$

Equation A-83

$$\theta_{10} = 7.76 \cdot C_S \cdot R \cdot I_e \text{ for mid- and high-rise buildings (4+ stories)}$$

Equation A-84

## **Appendix L. Reserved for Later Use**

## Appendix M. Evolution of Seismic Design Base Shear in Model Building Codes

### M.1. INTRODUCTION

How have building codes improved earthquake resilience of buildings over time? Is the history of building-code development one of monotonic increase in building strength, or have newer buildings gotten stronger, then weaker, then stronger than their predecessors? How have stiffness requirements changed? How does the evolution of resilience vary geographically, between buildings of different heights, seismic force resisting systems, and site conditions?

Several authors have examined many of these questions. For example, Beavers (2002) reviewed the theoretical developments and the developing forms of seismic design base shear over time. He touched on the impact of notable earthquakes on code provisions, and explained several paradigm shifts: the introduction of load and resistance factor design, probabilistic seismic hazard analysis, the MCE, and other theoretical considerations that manifested themselves in the seismic design provisions. Line (2006) reviewed the development of design procedures using wood structural panels over the period spanned by the 1955 UBC and the 2006 IBC, showing increases between 75% and 190%. As informative as these works are, the project team set out to quantify the evolution of design base shear and stiffness more exhaustively for various seismic environments, building types, building heights, and site conditions.

Model building codes of the 20<sup>th</sup> Century in the United States include the UBC (International Conference of Building Officials 1927 et seq.), the NBC (BOCA 1950 et seq.), a document simply called Building Code (National Board of Fire Underwriters 1905 et seq.), and the SBC (SBCCI 1946 et seq.). At the beginning of the 21<sup>st</sup> Century, NFPA (2002 et seq.) produced the *Building Construction and Safety Code*, shortly after the International Code Council (2000a, b et seq.) created the IBC and IRC in 2000, which merged the three so-called legacy codes (UBC, NBC, and SBC).

The UBC and IBC have dominated construction in the WUS where most of the country's earthquake risk originates. This appendix looks at one aspect of seismic design provisions in the UBC and IBC: design base shear, which here refers to the lateral strength of a new building to resist earthquake loads as a fraction of the building's weight. The appendix presents time series of seismic design base shear, meaning estimates versus time of the minimum lateral strength of a new building built to comply with successive editions of the UBC and IBC.

Seismic design procedures have appeared in model building codes since the 1927 edition of the UBC. They have grown in length and complexity, in several general ways:

1. By accounting for regional seismicity through the use of zone maps.

## NATURAL HAZARD MITIGATION SAVES:

2. By accounting for local differences in seismicity, first through the introduction of near-source terms and then through seismic microzonation, via several iterations of maps of rare shaking, maps produced the U.S. Geological Survey NSHMP and its predecessors.
3. By accounting for resonance of the building with earthquake ground motion, first through number of stories, and later via height and lateral force resisting system.
4. By accounting for the ductility capacity of the building's lateral force resisting system, with a gradually expanding list of systems, each with its own estimate of ductility capacity.
5. By accounting for the societal importance of a building through an earthquake importance factor  $I$ , later denoted  $I_e$ .
6. By accounting for the amplification of ground motion associated with lower shear wave velocity in surficial soil versus rock.
7. By changing from ASD to load and resistance factor design.
8. By changing from no explicit reliability goal, to one of low probability of life-threatening damage under shaking with a factor of 2,500-year shaking (as expressed in the reliability index underlying seismic design using load and resistance factor design), to low probability of collapse during the building's design life (as proposed by Luco et al. 2007).
9. By controlling displacement, again using a parameter that depends on lateral force resisting system.

## M.2. MAJOR DEVELOPMENTS IN UBC AND IBC BASE SHEAR REQUIREMENTS

One can illustrate the evolution of the model codes' seismic design provisions by plotting time series of important parameters. Many design aspects have evolved over time, such as those listed in Section 3.3.3. Among the more interesting of these is design base shear, to which ASCE 7-16 refers as seismic response coefficient,  $C_s$ , a dimensionless parameter. To better understand how codes have gradually evolved over time, one can create time series of  $C_s$  for different building types, heights, site conditions, and geographic locations. Without recapping every equation, table, and parameter value relevant to  $C_s$ , the project team estimated such time series, accounting for the following innovations of seismic design requirements for various buildings as they would have been designed for particular locations in downtown San Francisco, Portland, Oregon, and Seattle. This analysis focused primarily on the design base shear. The analysis categorized buildings using current FEMA model building types (W1, W2, etc.), height categories (low-rise, mid-rise, and high-rise), and NEHRP site classifications (B, C, D, and E).

The editions of the UBC included: 1927 (first version), 1930, 1935, 1937, and then every three years thereafter until the last edition in 1997. The IBC has adhered to a three-year development cycle since its inception in 2000. The following brief history notes only significant changes related to design base shear. It does not deal with the adoption of model codes by states, cities, or local jurisdictions, nor with the degree to which different jurisdictions have enforced those codes.

### 1927 *Uniform Building Code*

1. The building code states its intent: "The design of buildings for earthquake shocks is a moot question but the following provisions will provide adequate additional strength when applied in the design of buildings or structures."
2. Most buildings in cities "located within an area subject to earthquake shocks" are required to have lateral strength to resist earthquake of either 0.075 or 0.1 times building weight, depending on soil bearing capacity (4000 pounds per square foot of bearing capacity being the division), with a 50% increase in allowable stress for combined seismic and gravity loading. Building weight is taken as its dead load, i.e., the weight of the building's fixed components. Building weight also includes live loads (the estimated weight of occupants and movable contents) if they exceed 50 pounds per square foot, for example the weight of books in a library.
3. Allowable stress in seismic loading is increased 50% for steel and 33% for other materials, with other constraints for masonry and for thick reinforced-concrete walls.

1930 *Uniform Building Code*: no significant changes.

### 1935 *Uniform Building Code*

4. Intent changed: "To make buildings earthquake-resistive."
5. Extends requirements to more buildings.
6. Accounts for regional seismicity, through a zone factor with a zone map covering western states. Design base shear drops for zones with lower zone factors, such as Portland and Seattle.
7. Changes building weight  $W$  to dead load plus 50% of live load, except warehouses, where the weight is dead load plus 100% of the live load.
8. Introduces the formula  $F = C \times W$ , where  $F$  is the required lateral strength and  $C$  is a function of soils and location. Location is parameterized with three zones.
9. Changes allowable stress increase to 33% for seismic loads. Design base shear for steel buildings increases as a consequence.

1937 to 1946 *Uniform Building Codes*: no significant changes.

### 1949 *Uniform Building Code*

10. Four seismic zones rather than three (0, 1, 2, and 3), with zone 0 for no seismic requirements. Introduces a new seismic zone map, drawn by the United States Coast and Geodetic Survey (precursor to the USGS), covering contiguous 48 states.
11. In the formula  $F = C \times W$ ,  $C$  becomes a function of story height (decreasing with increasing height), no consideration of soils, and  $W$  is now only dead load, except warehouses, where it includes 100% of the live load. The change regarding height causes design base shear of low-, mid-, and high-rise buildings to diverge.

1952 to 1958 *Uniform Building Code*: no significant changes.

### 1961 *Uniform Building Code*

12. Statement of intent no longer appears.
13. New parameter  $Z$  accounts for the seismic zone, whose map is unchanged.
14. New parameter  $K$  varies with lateral force resisting system, of which there are five. As a consequence, design base shear for moment frames drops by a factor of 0.67, for example, and for box systems it rises by a factor of 1.33.
15. The equation for  $C$  changes, and accounts for the fundamental building period, which itself is estimated as a function of building height and plan depth.
16. Introduces new formula  $V = Z \times K \times C \times W$ .  $V$  denotes design base shear.  $W$  denotes building weight, which is taken as dead load only, except for warehouses where it includes 25% of live load.

### 1964 *Uniform Building Code*

17. Adds tanks to lateral force resisting systems, for a total of 6 systems.
18. Introduces new ductility requirements for moment-resisting frames.

### 1967 *Uniform Building Code*

19. Introduces new maximum value for coefficient  $C \leq 0.1$ .

### 1970 *Uniform Building Code*

20. Introduces a new zone map covering all 50 states and with contours that do not attempt to conform to political boundaries or meridians.

1973 *Uniform Building Code*: no significant changes.

### 1976 *Uniform Building Code*

21. Introduces new occupancy importance factor  $I$  with three possible values: 1, 1.25, and 1.5.
22. Introduces new equation for period as a function of lateral force resisting system, still with 6 systems and slight changes in some parameter values.
23. Eliminates default period for 1- and 2-story buildings.
24. Introduces new equation for  $C$  as a function of building period, and new maximum value for  $C = 0.12$ .
25. Introduces new soil term  $S$ , denoted as a “numerical coefficient for site-structure resonance” and defined in terms of building period and characteristic site period  $T_S$ , which one establishes from geotechnical data. Absent data to establish  $T_S$ ,  $S$  is taken as  $S = 1.5$ , which causes design base shear to rise relative to 1973.
26. Introduces new maximum value of the product  $C \times S \leq 0.14$ .
27. New map with five rather than four zones: 0, 1, 2, 3, and 4 and corresponding values of coefficient  $Z$ .
28. New equation for design base shear:  $V = Z \times I \times K \times C \times S \times W$ .
29. Introduces new interstory drift ratio limit of 0.5%.



## NATURAL HAZARD MITIGATION SAVES:

1979 and 1982 *Uniform Building Codes*: no significant changes.

### 1985 *Uniform Building Code*

30. Introduces new categorization of soil term  $S$  with associated values for  $S_1$ ,  $S_2$ , and  $S_3$ .
31. Introduces seventh lateral force resisting system: 1- to 3-story wood box system.

### 1988 *Uniform Building Code*

32. Introduces new zone map. No more zone 0, new zones 2A and 2B, and a new table of zone factor  $Z$ , now with 5 zones: 1, 2A, 2B, 3, and 4.
33. Introduces new importance factors with no more  $I = 1.5$ . Maximum  $I$  value is 1.25.
34. Accounts for ductility capacity; new  $R_w$  table with 29 lateral force resisting systems. The maximum value of  $R_w$  is 12 for concrete or steel special moment-resisting frames and dual systems with concrete shearwalls and special moment-resisting space frames. Concrete shearwalls also have a fairly high  $R_w$  of 8, versus their previous status in 1985 as a box system with an above-unity value of  $K$  (and therefore higher rather than lower design base shear). The design base shear of these building types drop dramatically. (Note that R. Lynn, in written communication on October 12, 2018, points out that “when I was on BSSC [the Building Seismic Safety Council], the validity of the  $R$  factors was extensively debated with regard both to understanding and validity of use.”)
35. Introduces new coefficient  $C$  equation.
36. Introduces new period  $T$  equation.
37. No more use of  $K$ .
38. No more use of building depth  $D$ .
39. New equation for design base shear:  $V = (Z \times I \times C/R_w) \times W$ .
40. New drift limits that account for  $R_w$ ; 0.4% limit on interstory drift ratio for buildings taller than 65 ft.

1991 *Uniform Building Code*: no significant changes.

### 1994 *Uniform Building Code*

41. Zonation map changes, especially for Oregon and much of Washington, which causes design base shear values in Portland, for example, to rise significantly.

### 1997 *Uniform Building Code*

42. New statement of purpose: “The purpose of the earthquake provisions herein is primarily to safeguard against major structural failures and loss of life, not to limit damage or maintain function.”
43. Introduces strength design to the seismic design equations.
44. Introduces new soil classification with 6 categories  $S_A$  through  $S_F$ .
45. Introduces new treatment of near-source effects requiring info about source type and distance.
46. Introduces new term  $N_o$  for near-source effects in constant-acceleration portion of the idealized response spectrum.

## NATURAL HAZARD MITIGATION SAVES:

47. Introduces new term  $N_v$  for near-source effects in constant-velocity portion of the idealized response spectrum.
48. Introduces new table of  $R_w$  with 43 lateral force resisting systems, with changes in values of  $R_w$ . Lower maximum of 8.5. Some building systems change  $R_w$  radically, such as steel light frame, whose  $R_w$  drops from 7 to 2.8, with consequent jump in  $C_s$ .
49. New drift limits for estimated inelastic response displacement: 2.5% for buildings with period less than 0.7 sec, 2.0% for buildings with period in excess of 0.7 sec. These drift ratios are calculated as  $0.7 \times R \times \Delta_s$ , where  $\Delta_s$  denotes the elastic response displacement. Inelastic response displacements are generally consistent with the 1994 UBC.

### 2000 *International Building Code*

50. Statement of intent: “[T]o establish the minimum requirements to safeguard the public health, safety and general welfare through structural strength, means of egress facilities, stability, sanitation, adequate light and ventilation, energy conservation, and safety to life and property from fire and other hazards attributed to the built environment.”
51. Rather than large geographic seismic zones, adopts microzonation with maps of MCE shaking on rock using short-period and 1-second damped elastic spectral acceleration, denoted by  $S_S$  and  $S_1$ . MCE shaking has 2% exceedance probability in 50 years.
52. Introduces new soil type F.
53. Introduces new nomenclature for soil types A through F rather than  $S_A$  through  $S_E$ .
54. Introduces new terms to account for site amplification in the constant-acceleration portion of the idealized response spectrum ( $F_a$ ) and in the constant-velocity portion of the idealized response spectrum ( $F_v$ ) related to 1997 UBC’s  $C_a$  and  $C_v$  but as functions of  $S_S$  and  $S_1$  rather than zone.
55. Expands table lateral force resisting systems to 73 systems. Some system  $R_w$  values change significantly, for example steel light frame, whose  $R_w$  changes from 2.8 to 6.0, with consequent drop in  $C_s$ .
56. Maximum earthquake importance factor  $I$  back up to 1.5.
57. New equation for deflection at any height, based on deflection determined by elastic analysis, amplified the ratio of a new parameter  $C_d$  to the earthquake importance factor. Parameter  $C_d$  varies with the seismic force resisting system. Drift limits generally consistent with 1997 UBC.

### 2003 *International Building Code*

58. Introduces new period equation.
59. Equation for base shear coefficient  $C_s$  now explicitly by reference to ASCE 7.
60. Expands table of lateral force resisting systems from 73 to 77, with new prestressed masonry shearwall systems and some changes to ductility capacities  $R$ .

### 2006 *International Building Code*

61. Expands table of lateral force resisting systems to 83 systems, with some changes to ductility capacities  $R$ .

2009 *International Building Code*: no significant changes.

### 2012 *International Building Code*

62. Introduces risk-targeted seismic design with new maps of  $MCE_R$  in terms of short-period and 1-second 5% damped elastic spectral acceleration response on rock. Exceedance frequency of  $MCE_R$  is no longer uniformly 2% in 50 years, but varies between approximately 0.7 to 1.2 times MCE shaking. The adjustment factor accounts for local seismicity and aims to ensure a uniform upper-bound probability of collapse of 1% in 50 years.
63. Expands table of lateral force resisting systems to 85 systems.

2015 *International Building Code*: no significant changes.

### 2018 *International Building Code*

64. Changes tables of  $F_a$  and  $F_v$  to correct the long-standing disconnect between them and the site conditions used for maps of  $S_S$  and  $S_1$ , namely soil at the boundary between NEHRP site classes B and C (i.e.,  $V_{s30} = 760$  m/sec). Previous tables of  $F_a$  and  $F_v$  treated the maps as if they were based on site class B.
65. New national seismic hazard maps.

## M.3. CS TIME SERIES

Calculation of the time series requires a few assumptions:

- Design strength is approximately 1.4 times the strength associated with ASD.
- Story height is 12.5 ft, based on the average from Emporis' data of 8,110 high-rise buildings that have both height and number of stories (Emporis Corporation 2007).
- Live load, where it matters, is taken as 20 pounds per square foot.
- Building depth, where it matters, is 50 ft, except for high-rise buildings, which are assumed to be 140 ft deep, based on the square root of the average plan area from the Emporis database.
- Source distance, where it matters (the 1997 UBC), is 10 km.
- Seismic source type, where it matters (the 1997 UBC), is A.
- Standard occupancy, meaning Risk Category II in the nomenclature of ASCE 7-16.
- Low-rise, mid-rise, and high-rise buildings are treated as if 1, 5, and 15 stories, respectively. Average number of stories in mid-rise buildings is taken from a survey of 97 mid-rise buildings in Pasadena, Los Angeles, San Jose, and San Francisco, as discussed in Cho and Porter (2016). For high-rise, the average is taken from the Emporis database.

## NATURAL HAZARD MITIGATION SAVES:

Without recapping every equation, table, and parameter value, which would run to dozens, possibly hundreds, of pages, estimated time series of  $C_s$  follow. Figure A-4 illustrates how the minimum  $C_s$  varies over time for low-rise buildings of various FEMA types built in downtown San Francisco, on various soil types. Figure A-5 shows how height affects  $C_s$ . Figure A-6 shows how the required minimum  $C_s$  varies over time for low-rise buildings on NEHRP site class C for three locations: San Francisco, California; Seattle, Washington; and Portland, Oregon.

# NATURAL HAZARD MITIGATION SAVES:

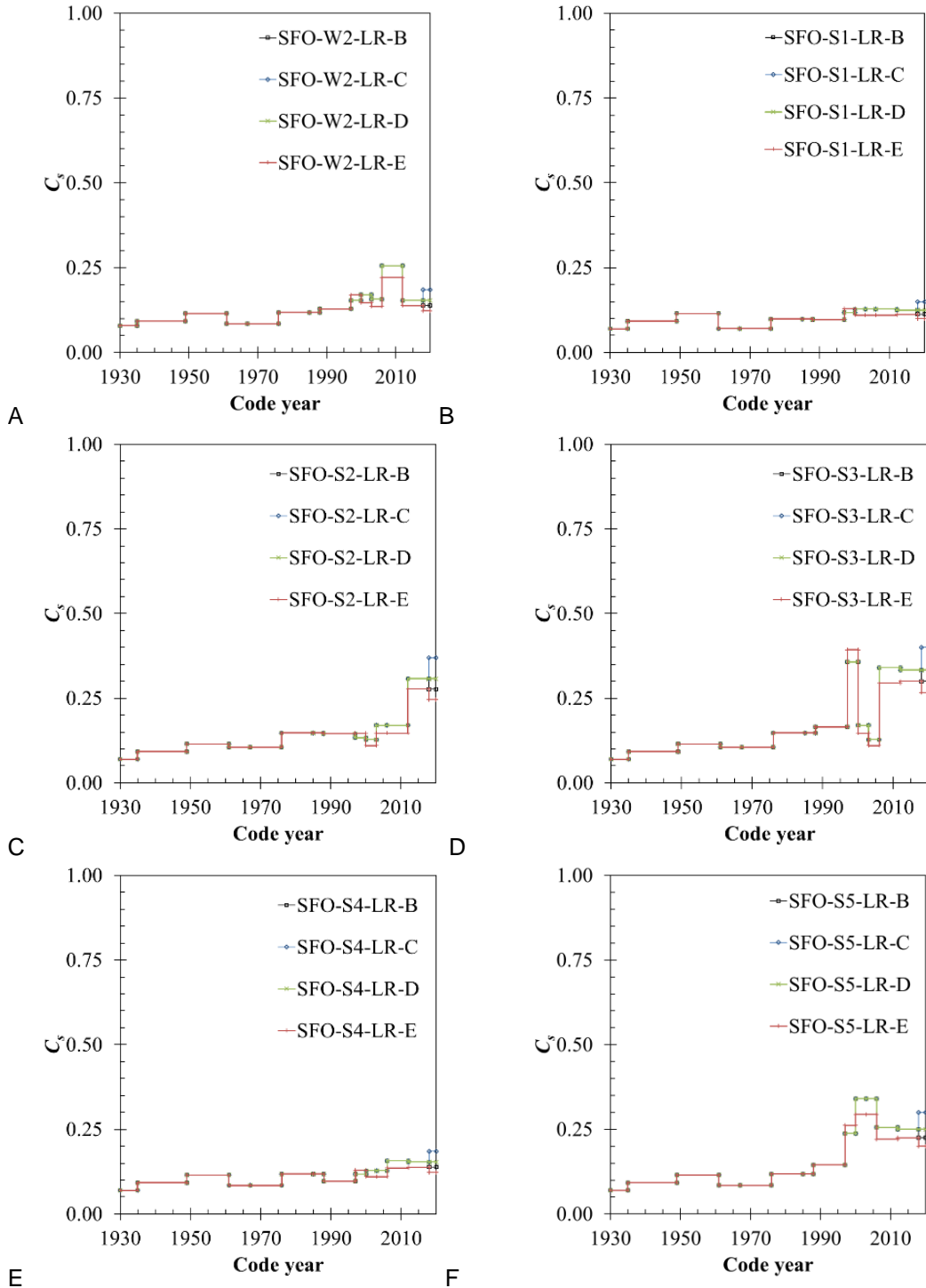

A: industrial woodframe, B: steel moment-resisting frame, C: steel braced frame, D: steel light frame, E: steel frame with cast-in-place reinforced concrete shearwalls, F: steel frame with masonry infill (later versions assume reinforced masonry). Legend acronyms: SFO means San Francisco; LR, low-rise; B, C, D, and E refer to NEHRP site classes.

Figure A-4:  $C_s$  time series for San Francisco site, low-rise construction, various NEHRP site classes.

# NATURAL HAZARD MITIGATION SAVES:

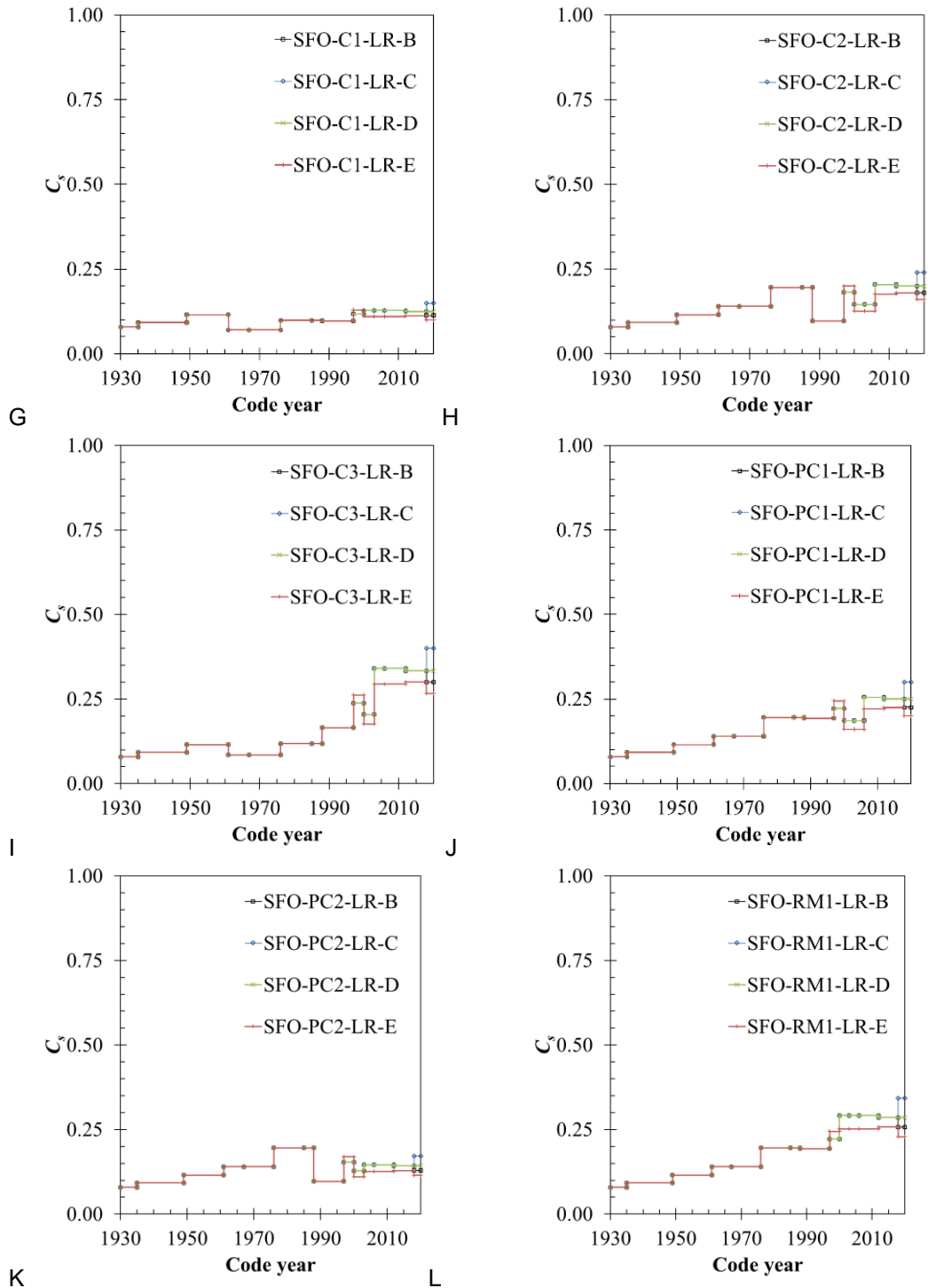

G: reinforced concrete moment frame, H: reinforced concrete shearwall, I: reinforced concrete frame with masonry infill; newer versions assume reinforced masonry infill, J: tiltup concrete, K: precast concrete frame, L: reinforced masonry shearwall with flexible diaphragms. Legend acronyms: SFO means San Francisco; LR, low-rise; B, C, D, and E refer to NEHRP site classes.

Figure A-4 (cont.):  $C_s$  time series for San Francisco site, low-rise construction, various NEHRP site classes.

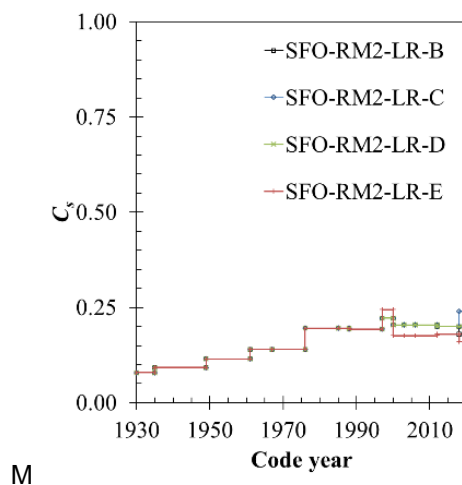

M: reinforced masonry shearwall with rigid diaphragms. Legend acronyms: SFO means San Francisco; LR, low-rise; B, C, D, and E refer to NEHRP site classes.

Figure A-4 (cont.):  $C_s$  time series for San Francisco site, low-rise construction, various NEHRP site classes.

# NATURAL HAZARD MITIGATION SAVES:

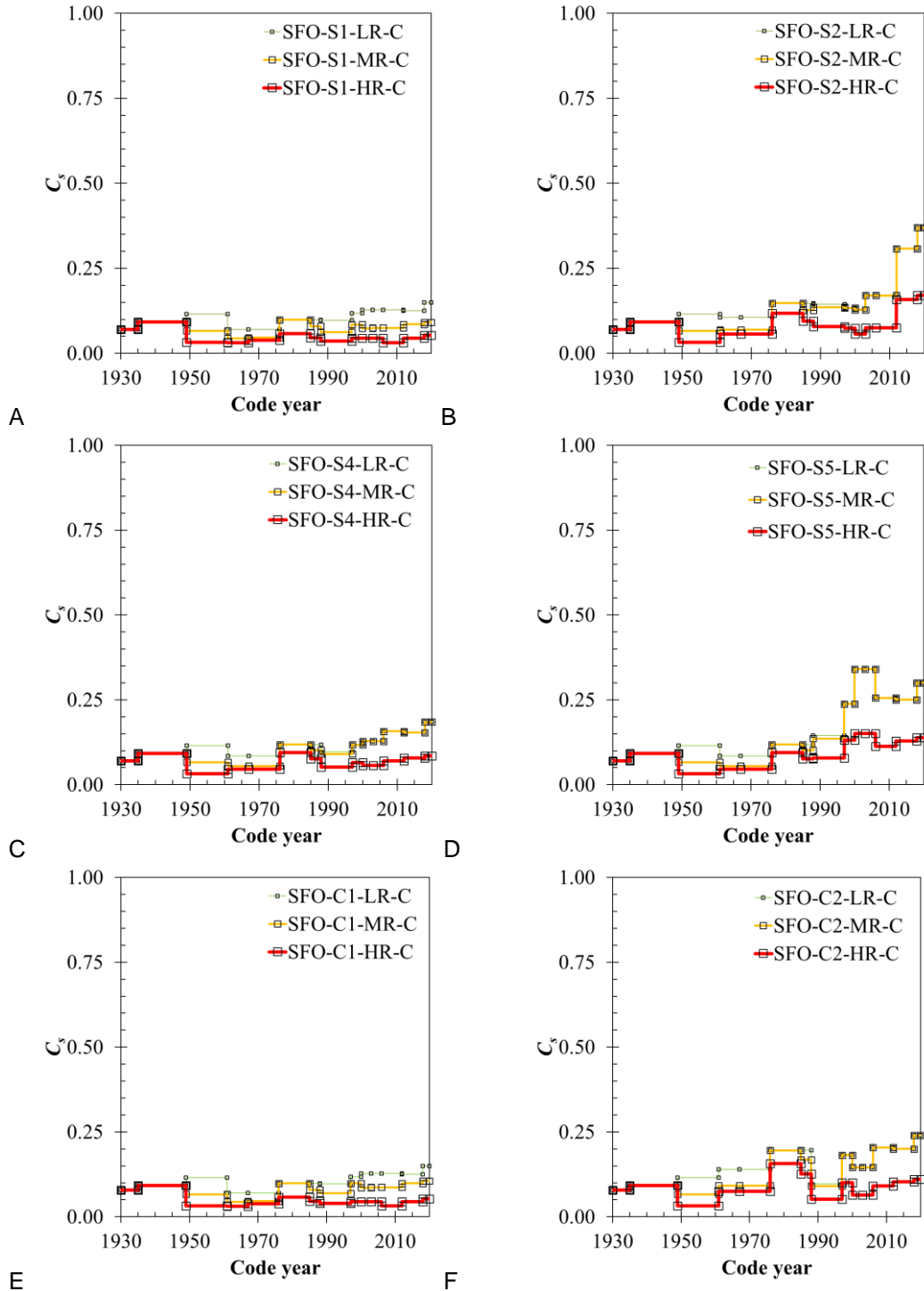

A: steel moment-resisting frame, B: steel braced frame, C: steel frame with cast-in-place reinforced concrete shearwalls, D: steel frame with masonry infill (later versions assume reinforced masonry), E: reinforced concrete moment frame, F: reinforced concrete shearwall. Legend acronyms: SFO means San Francisco; LR, low-rise; MR, mid-rise; HR, high-rise; C refers to the NEHRP site class.

Figure A-5:  $C_s$  time series for San Francisco site, NEHRP site class C, various heights.



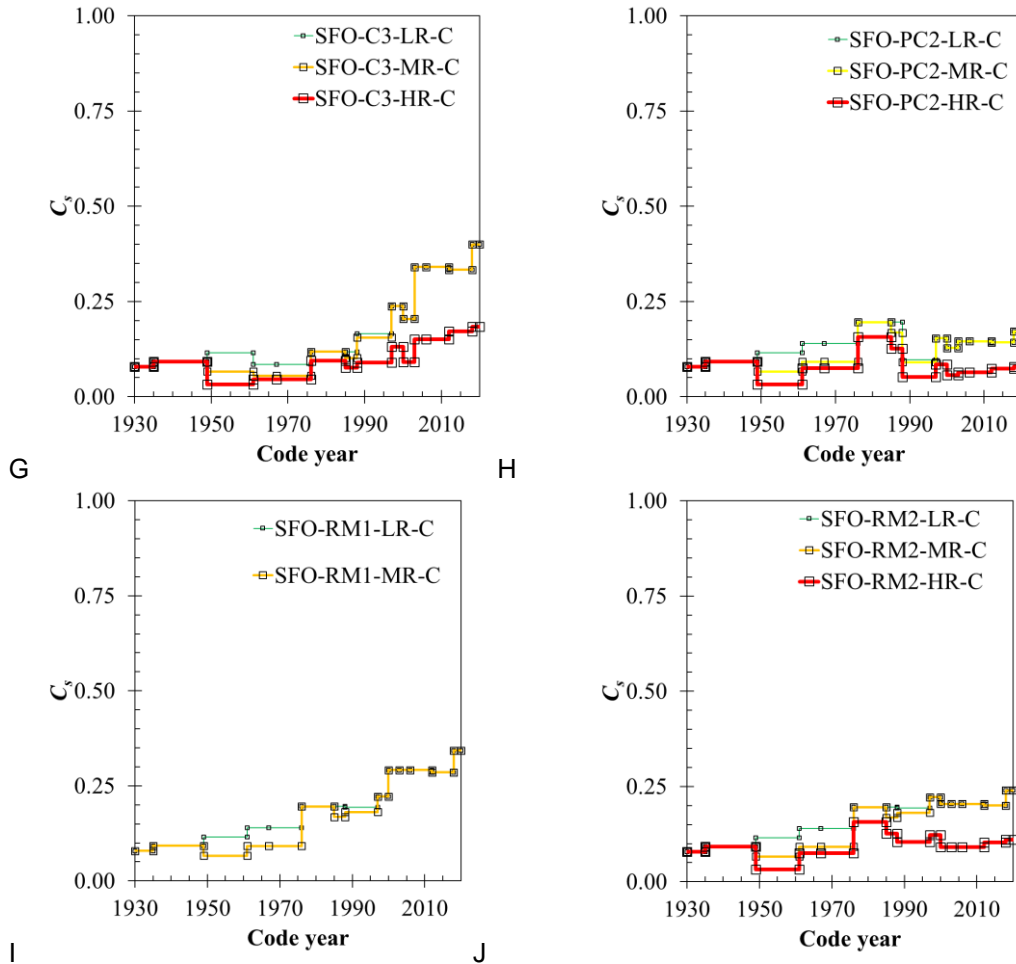

G: reinforced concrete frame with masonry infill; newer versions assume reinforced masonry infill, H: precast concrete frame, I: reinforced masonry shearwall with flexible diaphragms, J: reinforced masonry shearwall with rigid diaphragms. Legend acronyms: SFO means San Francisco; LR, low-rise; MR, mid-rise; HR, high-rise; C refers to the NEHRP site class.

Figure A-5 (cont.):  $C_s$  time series for San Francisco site, NEHRP site class C, various heights.

# NATURAL HAZARD MITIGATION SAVES:

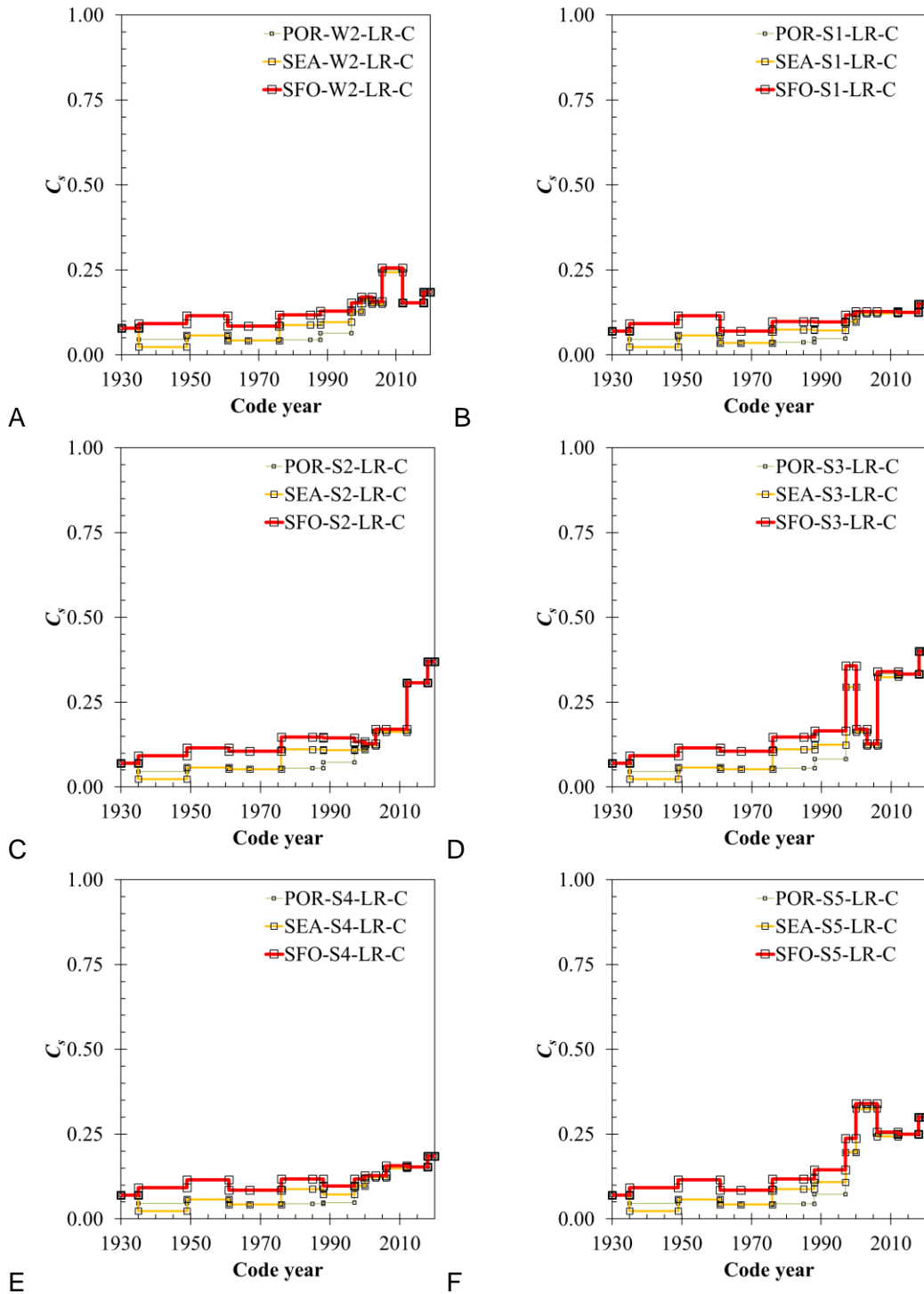

A: industrial woodframe, B: steel moment-resisting frame, C: steel braced frame, D: steel light frame, E: steel frame with cast-in-place reinforced concrete shearwalls, F: steel frame with masonry infill (later versions assume reinforced masonry). Legend acronyms: POR means Portland, Oregon; SEA Seattle, Washington; SFO San Francisco, California. LR, low-rise; C, NEHRP site class.

**Figure A-6:**  $C_s$  time series for various locations, low-rise construction, NEHRP site class C.

# NATURAL HAZARD MITIGATION SAVES:

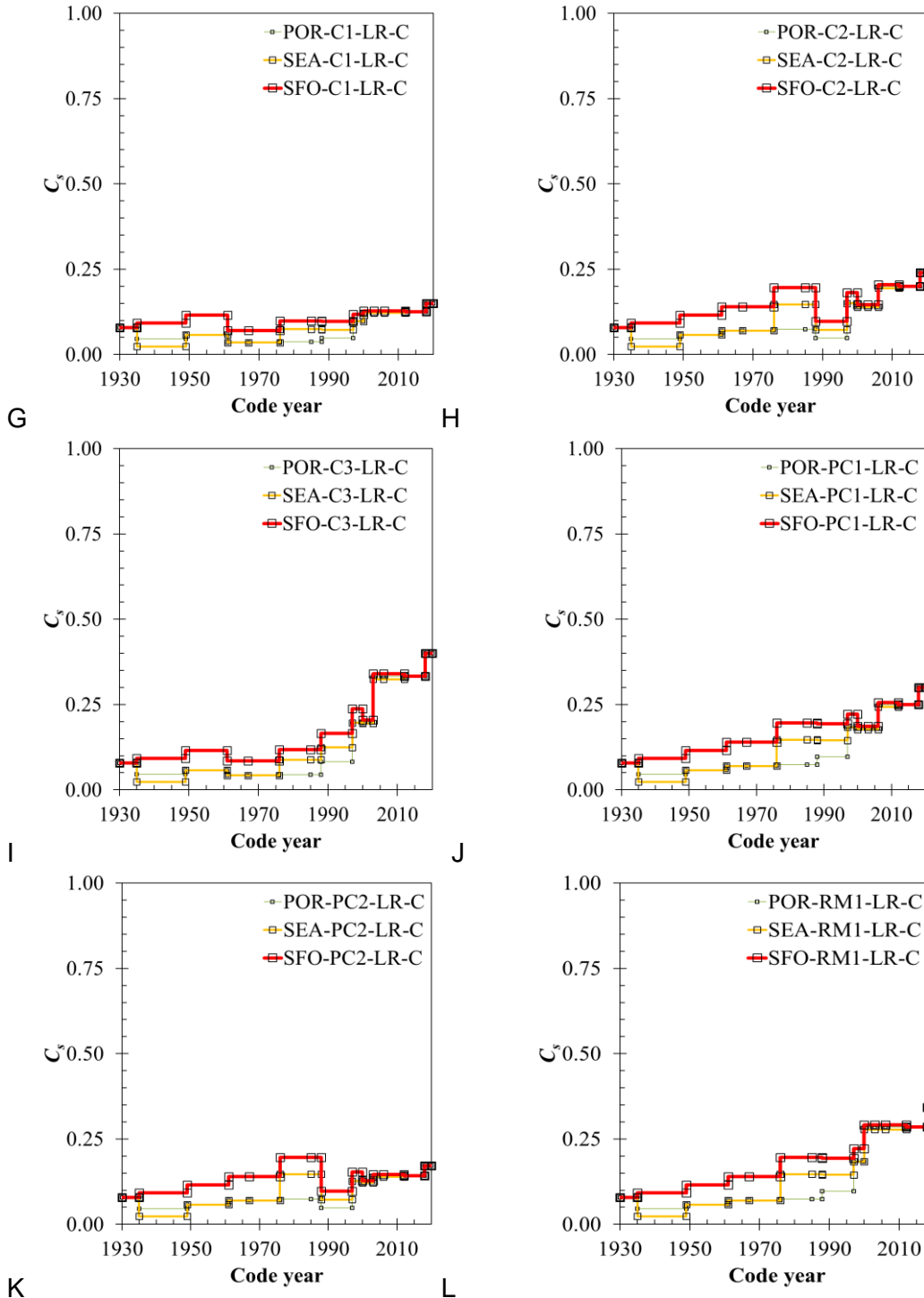

G: reinforced concrete moment frame, H: reinforced concrete shearwall, I: reinforced concrete frame with masonry infill; newer versions assume reinforced masonry infill, J: tiltup concrete, K: precast concrete frame, L: reinforced masonry shearwall with flexible diaphragms. POR means Portland, Oregon; SEA, Seattle; SFO, San Francisco; LR, low-rise; C, NEHRP site class.

Figure A-6 (cont.):  $C_s$  time series for various locations, low-rise construction, NEHRP site class C.

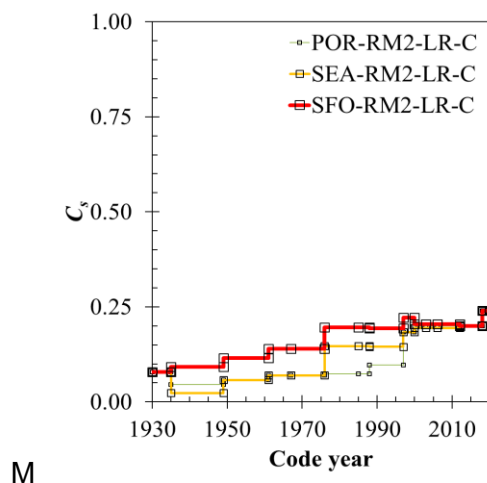

M: reinforced masonry shearwall with rigid diaphragms. Legend acronyms: POR means Portland, Oregon; SEA, Seattle; SFO, San Francisco; LR, low-rise; C, NEHRP site class.

Figure A-6 (cont.):  $C_s$  time series for various locations, low-rise construction, NEHRP site class C.

## M.4. OBSERVATIONS AND CONCLUSIONS

The project team’s analysis quantifies the design base as it has evolved over the life of the UBC (1927 through 1997) and the IBC (2000 through 2018). Design base shear in these model codes has not monotonically increased over time, although the general trend has been toward ever-stronger buildings.

After 1949, differences between seismic force resisting systems strongly affected  $C_s$ . At some points in time,  $C_s$  values for different building types differed by more than 3 times for the same location, height, and site class. Time series for low-rise and mid-rise buildings tended to experience greater increases over time than do those of high-rise buildings. The Portland and Seattle time series showed larger increases over time than those of San Francisco. Portland and Seattle time series dropped significantly with the introduction of seismic zones in 1935, but then tended to converge with San Francisco in 1997. Compared with the effects of building type, height, and geographic location, NEHRP site class tended to make only a modest difference, at least in San Francisco.

The project team characterized the gradual, long-term increase in strength in an approximate way by fitting trendlines to individual time series, or in a more-approximate way by calculating an equally weighted average of all the time series shown here and fitting a trendline to it (Figure A-7). The trendline suggests a long-term average annual increase in design base shear of approximately 4% per 3-year code cycle, or approximately 50% per 30 years, with no obvious sign of slowing. Combinations of building type, soil, and height are *not* equally likely, so this rate of growth is only notional, but still interesting.

Since the 1976 UBC introduced drift limits, they have remained largely constant, even as design base shear increased, indicating that required stiffness has increased in proportion with design base shear. Thus, as

## NATURAL HAZARD MITIGATION SAVES:

design base shear increased at a rate of 50% per 30 years, so has stiffness. The project team concluded that buildings that meet current I-Codes, or at least the 2018 IBC, are substantially stronger, stiffer, and more resilient than those built to older codes, and that in general, code development for seismic design has made society much safer and more resilient, probably in a cost-effective way.

This appendix addresses neither the adoption of model building codes by local jurisdictions, nor code enforcement, nor the skill or understanding local practitioners have brought to practice. All of these issues would affect the actual resilience the code has provided over time and between jurisdictions.

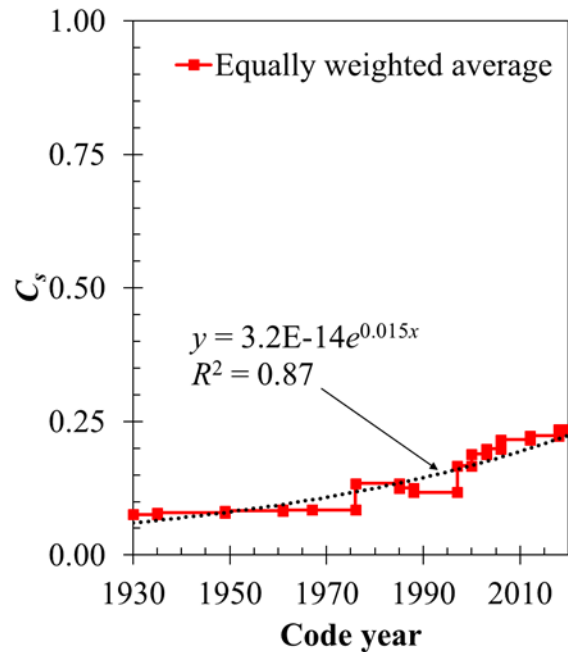

**Figure A-7:** The long-term trend in design base shear suggests 4% increase per 3-year code cycle, or 50% per 30 years. With constant drift limits, stiffness has increased in proportion.

## Appendix N. Where Required Seismic Design Strength Exceeds Required Wind Strength

In what U.S. locations do seismic design requirements of the 2018 International Building Code exceed those of wind design, as far as building strength is concerned? The question mostly applies to buildings whose structural material is reinforced masonry, steel, or reinforced concrete—i.e., materials other than wood. According to unpublished calculations by the project team using the Hazus building inventory, the FEMA model building type other than wood (i.e., other than FEMA types W1 and W2) with the greatest aggregate floor area is reinforced masonry with flexible diaphragms (FEMA type RM1). Based on the project team’s general familiarity with U.S. construction, the most common height of a U.S. building is 1 story tall. One can therefore simplify the question by calculating the wind and seismic force on a 1-story RM1 building, and determining in which locations the seismic lateral load exceeds wind and vice versa.

In the following analysis, ASCE 7-16, as well as all parameters, tables, and equations, refer to American Society of Civil Engineers (2017), unless noted otherwise. The analysis examines a 1-story, Risk-Category II RM1 building 50 ft long by 30 ft wide in the central United States, in exposure category B (generally suburban) surroundings. For example, consider Cullman County, Alabama, census tract 01043965500, near 34.01N -86.91E. (US Census Bureau, 2018).

Calculate design base shear for seismic loading as a factor of  $S_S$ :

$$C_s = 2/3 \times F_a \times S_S \times W / (R \times I_e)$$

Weight  $W$

Masonry walls: 160 ft × 12 ft × 0.67 ft × 150 pcf = 200 kip

Roof: 1500 sf × 10 psf = 15 kip

Other: say 15 kip

Total weight ≈ 230 kip

$$I_e = 1.0$$

$R = 3.5$  (intermediate reinforced masonry shear walls)

$$\begin{aligned} C_s &= 2/3 \times S_{MS}/(3.5 \times 1.0) \times 230 \text{ kip} \\ &= 43.8 \text{ kip} \times S_{MS} \end{aligned}$$

The maps of  $S_S$  and  $S_1$  in ASCE 7-16 appear to date from 2012, according to U.S. Geological Survey (2012). The values at 34.01, -86.91 are  $S_S = 0.2553g$ ,  $S_1 = 11.22g$ . According to OpenSHA’s Site data app (Field et al. 2005),  $V_{s30} = 355 \text{ m/sec}$ , which translates to NEHRP site class D ( $180 \text{ m/sec} \leq V_{s30} < 360 \text{ m/sec}$ ). According to ASCE 7-16 Table 11.4-1 by linear interpolation of  $S_S$  between 0.25 and 0.50,  $F_a = 1.592$ . Then

## NATURAL HAZARD MITIGATION SAVES:

$$S_{MS} = F_a \times S_s = 1.59 \times 0.26g = 0.41g.$$

$$C_s = 43.8 \text{ kip} \times 0.41g \\ = 18.0 \text{ kip}$$

Calculate design base shear for wind loads for U.S. interior

ATC's hazard tool (Applied Technology Council, ND) shows this site's basic windspeed to be  $V = 106$  mph. See Figure A-8. Also see ASCE 7-16 Fig. 26.5-1B.

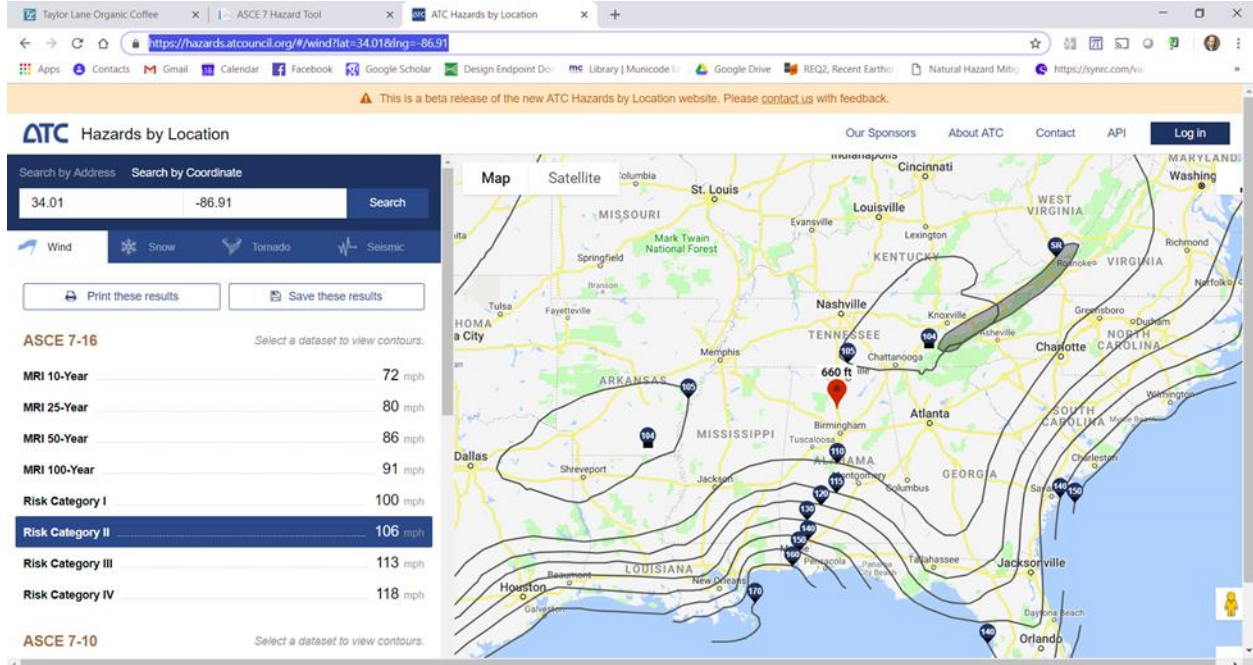

Figure A-8: Basic wind speed from ATC hazard tool.

Wind directionality factor  $K_d$  Table 26.6-1.

$$K_d = 0.85$$

Exposure category Sec 26.7 Roughness B.

Exposure B

Topo factor  $K_{zt}$  Figure 26.8-1.

$$K_1 = 0$$

$$K_2 = 0$$

$$K_3 = 0$$

$$K_{zt} = 1$$

Ground elevation factor,  $K_e$ ; see Section 26.9

$$K_e = 1$$

## NATURAL HAZARD MITIGATION SAVES:

Gust-effect factor,  $G$  or  $G_f$ ; see Section 26.11.

$$G = 0.85$$

Enclosure classification; see Section 26.12.

Partially enclosed.

Internal pressure coefficient, ( $GC_{pi}$ ); see Section 26.13 and Table 26.13-1.

$$GC_{pi} = \pm 0.55$$

Step 4: Determine velocity pressure exposure coefficient,  $K_z$  or  $K_h$ ; see Table 26.10-1.

$$K_h = K_z = 0.57$$

Step 5: Determine velocity pressure  $q_z$  or  $q_h$ , Equation 26.10-1.

Windward walls  $q_z$

$$\begin{aligned} q_z &= 0.00256 \times K_z \times K_{zt} \times K_d \times K_e \times V^2 \\ &= 0.00256 \times 0.57 \times 1 \times 0.85 \times 1 \times 106^2 \\ &= 13.9 \text{ psf} \end{aligned}$$

Leeward walls  $q_h$

$$q_h = q_z = 13.9 \text{ psf}$$

Step 6: Determine external pressure coefficient,  $C_p$  or  $C_{N1}$ :

Windward wall  $C_p = 0.8$

Leeward wall  $L/B = 30 \text{ ft}/50 \text{ ft}$ , so  $C_p = -0.5$

Step 7: Calculate wind pressure,  $p$ , on each building surface:

Equation 27.3-1 for rigid and flexible buildings.

Equation 27.3-1 & Figure 27.3-1 for walls and flat, gable, hip, monoslope, or mansard roofs.

Windward wall:

$$\begin{aligned} q_i &= q_z = 13.9 \text{ psf} \\ p &= q \times G \times C_p - q_i \times GC_{pi} \\ &= 13.9 \text{ psf} \times 0.85 \times 0.8 - 13.9 \text{ psf} \times -0.55 \\ &= 17.1 \text{ psf} \end{aligned}$$

Leeward wall

$$\begin{aligned} p &= 13.9 \text{ psf} \times 0.85 \times 0.5 - 13.9 \text{ psf} \times -0.55 \\ &= 13.6 \text{ psf} \end{aligned}$$

$$\begin{aligned} F_{wind} &= (17.1 \text{ psf} + 13.6 \text{ psf}) \times 50 \text{ ft} \times 12 \text{ ft} \\ &= 18.4 \text{ kip} \end{aligned}$$

Conclusion: for  $V = 106 \text{ mph}$ , wind design governs

$$44 \text{ kip} \times S_{MS} < F_{wind}$$

$$18.0 \text{ kip} < 18.4 \text{ kip}$$



## NATURAL HAZARD MITIGATION SAVES:

Batch calculations are carried out in several steps:

1. 2018 census tract geographic centroids are extracted from U.S. Census Bureau (2018) and rounded to the near 0.01 degrees of latitude and longitude.
2. For each centroid,  $V_{s30}$  is estimated using OpenSHA site data application (Field et al. 2005).
3. ASCE 7-16  $S_S$  and  $S_1$  values for each census tract are extracted from U.S. Geological Survey (2012).
4. ASCE 7-16  $F_a$  and  $F_v$  values are calculated for each census tract using ASCE 7-16 Tables 11.4-1 and 11.4-2, and  $S_{MS}$  and  $S_{M1}$  calculated using  $S_s$ ,  $S_1$ ,  $F_a$ , and  $F_v$ .
5. County-maximum values of  $S_{MS}$  and  $S_{M1}$  are calculated from tracts.
6. County-maximum basic wind speed are calculated in ArcGIS using ASCE 7-16's basic wind speed maps for risk category II buildings
7. Wind and seismic forces are calculated for the sample building for each county. Figure A-9 shows the result.

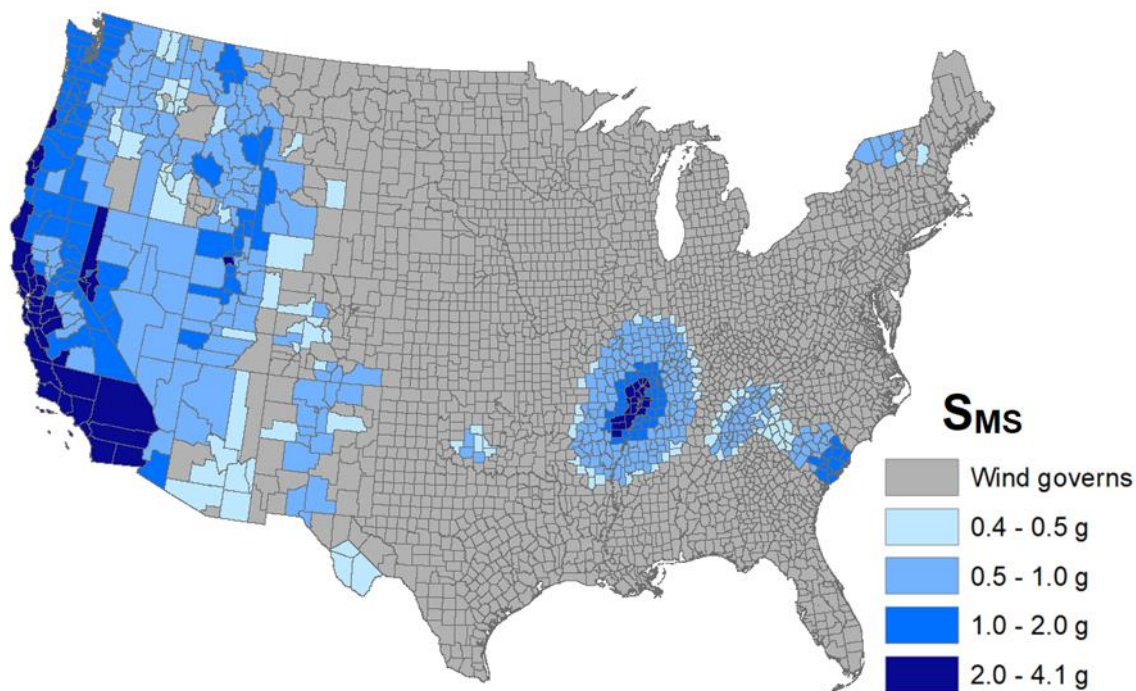

Figure A-9: County maximum values of  $S_{MS}$  where  $C_s$  exceeds  $F_{wind}$ .



1090 Vermont Avenue, NW, Suite 700  
Washington, DC 20005  
Phone: 202-289-7800  
[www.nibs.org](http://www.nibs.org)