

Fall 11-1-1981

Input Impedance to a Prob-fed Rectangular Microstrip Patch Antenna

Jayanti Venkataraman
University of Colorado Boulder

David C. Chang
University of Colorado Boulder

Follow this and additional works at: <https://scholar.colorado.edu/elmimi>

Recommended Citation

Venkataraman, Jayanti and Chang, David C., "Input Impedance to a Prob-fed Rectangular Microstrip Patch Antenna" (1981).
Electromagnetics Laboratory/The MIMICAD Research Center. 90.
<https://scholar.colorado.edu/elmimi/90>

This Technical Report is brought to you for free and open access by Electrical, Computer & Energy Engineering at CU Scholar. It has been accepted for inclusion in Electromagnetics Laboratory/The MIMICAD Research Center by an authorized administrator of CU Scholar. For more information, please contact cuscholaradmin@colorado.edu.

Scientific Report No. 69

INPUT IMPEDANCE TO A PROBE-FED RECTANGULAR
MICROSTRIP PATCH ANTENNA*

by

Jayanti Venkataraman and David C. Chang

November 1982

Electromagnetics Laboratory
Department of Electrical Engineering
University of Colorado
Boulder, Colorado 80309

*This work was supported by the Army Research Office under contract no. DAAG29-81-K-0112 to New Mexico State University and in part by ONR under contracts no. N00014-76-C-0318 and N00014-82-K-0264.

INPUT IMPEDANCE TO A PROBE-FED RECTANGULAR
MICROSTRIP PATCH ANTENNA[†]

Jayanti Venkataraman^{††} and David C. Chang^{†††}

ABSTRACT

An improved theory for the input impedance of a probe-fed microstrip patch antenna has been developed. The natural modes are established on a transverse resonance condition which incorporates the angularly dependent reflection coefficients and a dynamic wall susceptance associated with the patch boundaries. The input reactance is shown to be largely associated with the evanescent waves confined to the vicinity of the probe while the input resistance is associated with the excitation of the mode at resonance. Analytical results are presented to describe the input impedance of a rectangular patch antenna as a function of its dimensions, substrate thickness and dielectric constant, probe dimensions and location and the frequency.

[†]This work was supported by the Army Research Office under contract no. DAAG29-81-K-0112 to New Mexico State University and in part by ONR under contracts no. N00014-76-C-0318 and N00014-82-K-0264.

^{††}Jayanti Venkataraman was a Research Associate with the New Mexico State University from April 1980 to June 1981 and then assigned to the University of Colorado, Boulder during the period July 1981 to Aug. 1982. She is now with the Rochester Institute of Technology, Rochester, NY 14623.

^{†††}David C. Chang is with the Electromagnetics Laboratory, Department of Electrical Engineering, University of Colorado, Boulder, CO 80309.

1. Introduction

Mathematical modeling of the basic microstrip radiator was initially carried out by applying the transmission line analogy [1,2] and then later by the cavity model [3-5]. Both these theories have the same difficulty to account properly for the dispersion of the grounded dielectric. Of particular interest here is the modal expansion method used in the cavity theory [3]; the interior fields here are assumed to be composed of discrete modes obtained from a fixed angularly independent wall reflection coefficient. The effect of radiation is represented in an ad hoc manner in terms of an increased substrate loss tangent [3] or by the method of impedance boundary condition at the walls [5].

In a recent paper by Chang [6] resonant characteristics of an unloaded rectangular microstrip patch antenna were determined from the viewpoint of plane waves that propagate under the microstrip patch, bounding back and forth from the edges and interacting in a constructive manner. Analytical expressions were derived in [8] for the reflection coefficient of a plane wave incident obliquely on to the patch boundaries by solving a dual Wiener-Hopf equation [7]. In this paper our purpose is to extend this method to a loaded resonant patch antenna fed by a thin-wire current probe located under the microstrip patch. Input impedance for a resonant patch is then determined analytically in closed form. Simple expressions under a thin wire, thin-substrate assumption is obtained and compared with those in the literature.

2. Excitation of guided modes on a wide microstrip stripline

In order to develop a dispersive model for the resonance of a rectangular probe-fed microstrip patch antenna we first need to consider the corresponding problem of an infinitely long microstrip stripline of the same width and examine the excitation of guided modes on such a structure. As depicted in Fig. 1 a microstrip of width ℓ is situated on the surface of a grounded dielectric substrate of thickness d and relative permittivity ϵ_r ; a current probe of radius a is located at (x_0, y_0) and assumed to have a filament current of $I_0 \exp(-i\omega t)$ where ω is the angular operating frequency and I_0 is the amplitude of the current. We assume that the thickness d is electrically very small, i.e., $k_0 d \ll 1$ where k_0 is the free space wave number and that the width of the microstrip is much greater than the thickness, i.e. $\ell^2 \gg d^2$, so that the requirement of a constant current distribution is a reasonable one. It also allows us to consider the guided modes supported by the structure as a result of constructive interference of plane waves emanating from the current probe because the microstrip in effect forms a truncated parallel-plate waveguide in the presence of the ground plane. Having said that, we can write down without difficulty the complete plane wave spectrum of the electric field in a parallel plate region as

$$E_z = A_0 \int_{-\infty}^{\infty} e^{ik_0 \alpha (x-x_0)} e^{ik_0 \sqrt{n^2 - \alpha^2} (y_> - y_<)} \frac{d\alpha}{(n^2 - \alpha^2)^{1/2}} \quad (1)$$

where

$$y_< = \max_{\min} (y, y_0)$$

and

$$A_0 = -\frac{\omega \mu I_0}{4\pi} \quad (2)$$

Reflection occurs as these plane waves represented by $\exp ik_0 [\pm \alpha x \pm (n^2 - \alpha^2)^{1/2} y]$ impinge onto the two edges of the microstrip stripline.

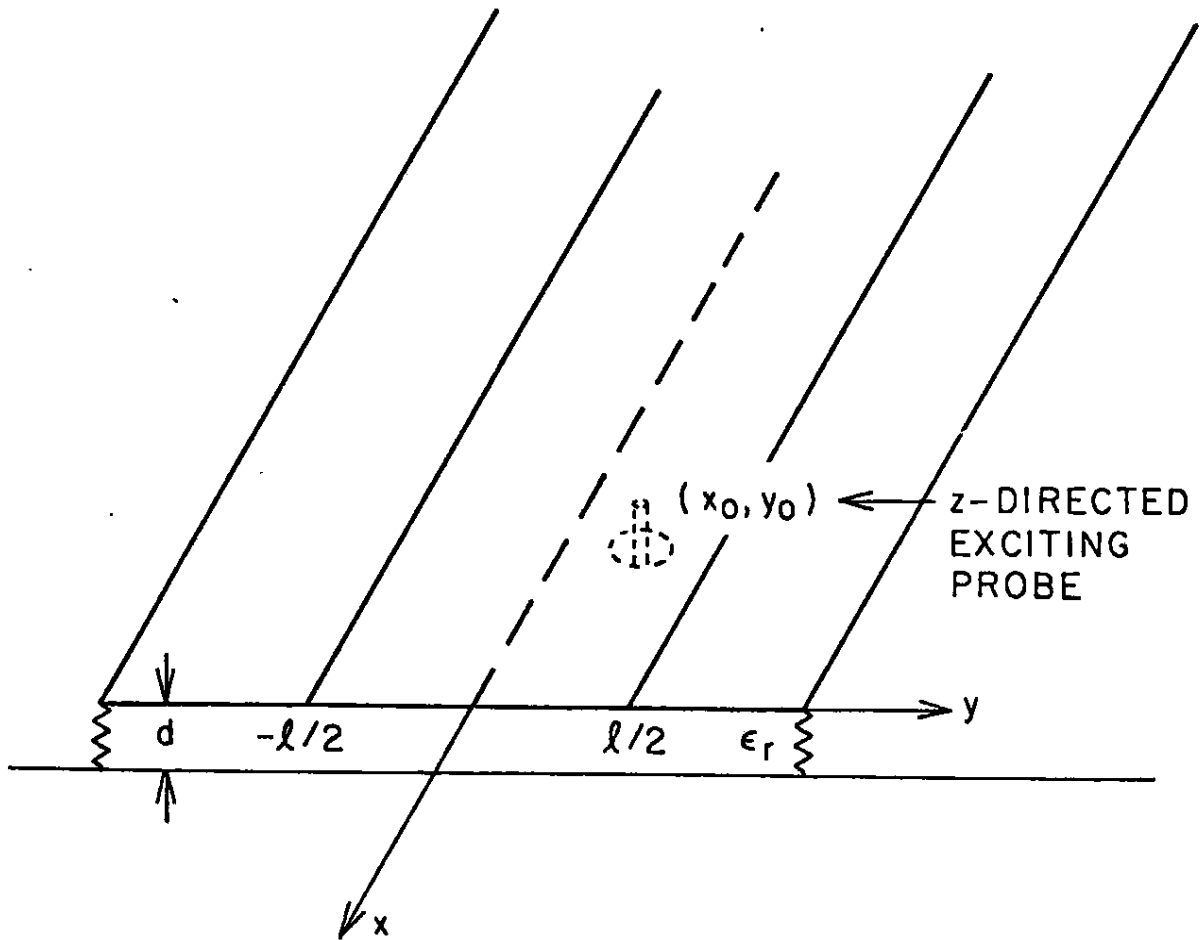

Fig. 1 . Infinitely extending wide microstrip stripline.

Denoting the reflection coefficient as $\Gamma(\alpha)$ for a wave reflected from the edge at an angle defined by $\tan^{-1}[\alpha/(n^2-\alpha^2)^{1/2}]$ we can derive the expression for the total field under the microstrip by first assuming the form of the solution as

$$E_z = A_0 \int_{-\infty}^{\infty} e^{ik_0 \alpha (x-x_0)} \left[e^{ik_0 \xi (y-y_0)} + A e^{ik_0 \xi (\frac{l}{2} y)} + B e^{ik_0 \xi (y + \frac{l}{2})} \right] \frac{d\alpha}{\sqrt{n^2 - \alpha^2}} \quad (3)$$

where

$$\xi = (n^2 - \alpha^2)^{1/2} \quad (4)$$

A and B are the amplitudes of the waves bouncing back from the edges located at $y = \pm l/2$. Expressions for A and B can then be determined by imposing the known conditions

$$A = (e^{ik_0 \xi y_0} + \beta e^{ik_0 \xi l/2}) \Gamma(\alpha) e^{ik_0 \xi l/2} \quad (5)$$

$$B = (e^{ik_0 \xi y_0} + A e^{ik_0 \xi l/2}) \Gamma(\alpha) e^{ik_0 \xi l/2} \quad (6)$$

which after some manipulation yields

$$E_z = A_0 \int_{-\infty}^{\infty} \frac{d\alpha}{\xi} e^{ik_0 \alpha (x-x_0)} \left[e^{ik_0 \xi |y-y_0|} + \frac{2\Gamma(\alpha) e^{ik_0 \xi l}}{\Delta_n} \times \{ \cos k_0 \xi (y+y_0) + \Gamma(\alpha) e^{ik_0 \xi l} \cos k_0 \xi (y-y_0) \} \right] \quad (7)$$

where

$$\Delta_n = 1 - \Gamma^2(\alpha) e^{2ik_0 \xi l} \quad (8)$$

Integral representation for $\Gamma(\alpha)$ has been previously obtained by Chang and Kuester [7] based upon a Wiener-Hopf formulation of a semi-infinite patch. A close form expression under the assumption of a thin substrate is given in [8] and repeated in the Appendix A for convenience. We note from (A.1) that the magnitude of $\Gamma(\alpha)$ is equal to one for $\alpha > 1$. Physically this means that a total reflection of the incident wave and

therefore the possibility of establishing a transverse resonance of waves bouncing back and forth between the two edges can indeed exist. Letting the phase of $\Gamma(\alpha)$ be defined as $\chi(\alpha)$, i.e. $\Gamma(\alpha) = \exp(-ix(\alpha))$, a constructive interference of waves occurs whenever

$$k_0 \ell (n^2 - \alpha^2)^{1/2} - \chi(\alpha) = p\pi; \quad p = 0, 1, 2, \dots \quad (9)$$

This is precisely the same condition for the denominator, Δ_n in (8) to vanish. If we thus allow ourselves to deform the contour to the upper half of a complex α -plane for $y > y_0$, or to the lower half plane for $y < y_0$, the residue contribution from the poles in (8) yields exactly the excitation of the guided mode(s) supported by a microstrip stripline. In most practices, the width ℓ is chosen to permit a solution only for $p = 0$ so that the field corresponding to this mode is given as

$$E_{z0} = \frac{4\pi A_0 \cos(k_0 \xi_0 y) \cdot \cos(k_0 \xi_0 y_0)}{(\xi_0 \chi'(\alpha_0) + k_0 \ell \alpha_0)} e^{ik_0 \xi_0 (x_> - x_<)} \quad (10)$$

where $x_{>} = \max(x, x_0)$, $x_{<} = \min(x, x_0)$, $\xi_0 = (n^2 - \alpha_0^2)^{1/2}$ and $\chi'(\alpha_0)$ is the differentiation of $\chi(\alpha)$ with respect to α at $\alpha = \alpha_0$. We note that the value of α_0 can be determined exactly from the transcendental equation given in (9). We should point out that in deriving the transverse resonance condition, we have obviously ignored the coupling between the two edges via the top surface of the microstrip. However, from the Wiener-Hopf derivation given in [7] we can easily establish that the omission of the external coupling is in the order of $k_0 d \exp[-k_0 \ell (n^2 - 1)^{1/2}]$ which is typically very small. This is because of our approximations of a thin substrate ($k_0 d \ll 1$) for a relatively wide microstrip (say, $\pi > nk_0 \ell > 2\pi$).

In addition to the guided mode, one certainly expects the presence of a reactive field (equivalent to the higher order evanescent modes in a

closed metallic waveguide) and a spurious radiation field when a current source is placed inside an open waveguide structure. Indeed a closer examination of the expression $\Gamma(\alpha)$ given in (A.1) indicates that the integral representation for E_z contains a pair of branch cuts $(1 - \alpha^2)^{1/2}$ in the complex α -plane. This means that, when we deform the contour in the upper (or lower) half plane and thereby pick up the residue contribution from the guided wave pole(s), the expansion is really not complete unless we also include a branch cut integration at $\alpha = 1$ (or $\alpha = -1$) as shown in Fig. 2a.

Provided that the substrate is electrically thin ($k_0 d \ll 1$) it is shown in the Appendix B that we can ignore the spurious radiation and represent the reactive field by an expression corresponding to the case when the microstrip is enclosed by a pair of perfect magnetic walls. Consequently, the total electric field under the microstrip is given by $E_z = E_{z0} + E_{zr}$ where E_{zr} is the reactive field given in terms of the residues at the poles corresponding to the evanescent modes shown in Fig. 2b:

$$E_{zr} = \frac{2\pi A_0}{k\ell} \sum_{p=1}^{\infty} \frac{1}{\alpha_p} e^{ik_0 \xi_p (x_> - x_<)} \left[\cos \frac{p\pi}{\ell} (y+y_0) + (-1)^p \cos \frac{p\pi}{\ell} (y-y_0) \right] \quad (11)$$

where

$$\xi_p = (n^2 - \alpha_p^2)^{1/2} \quad (12)$$

and

$$\alpha_p = \left[n^2 - \left(\frac{p\pi}{k\ell} \right)^2 \right]^{1/2} \quad (13)$$

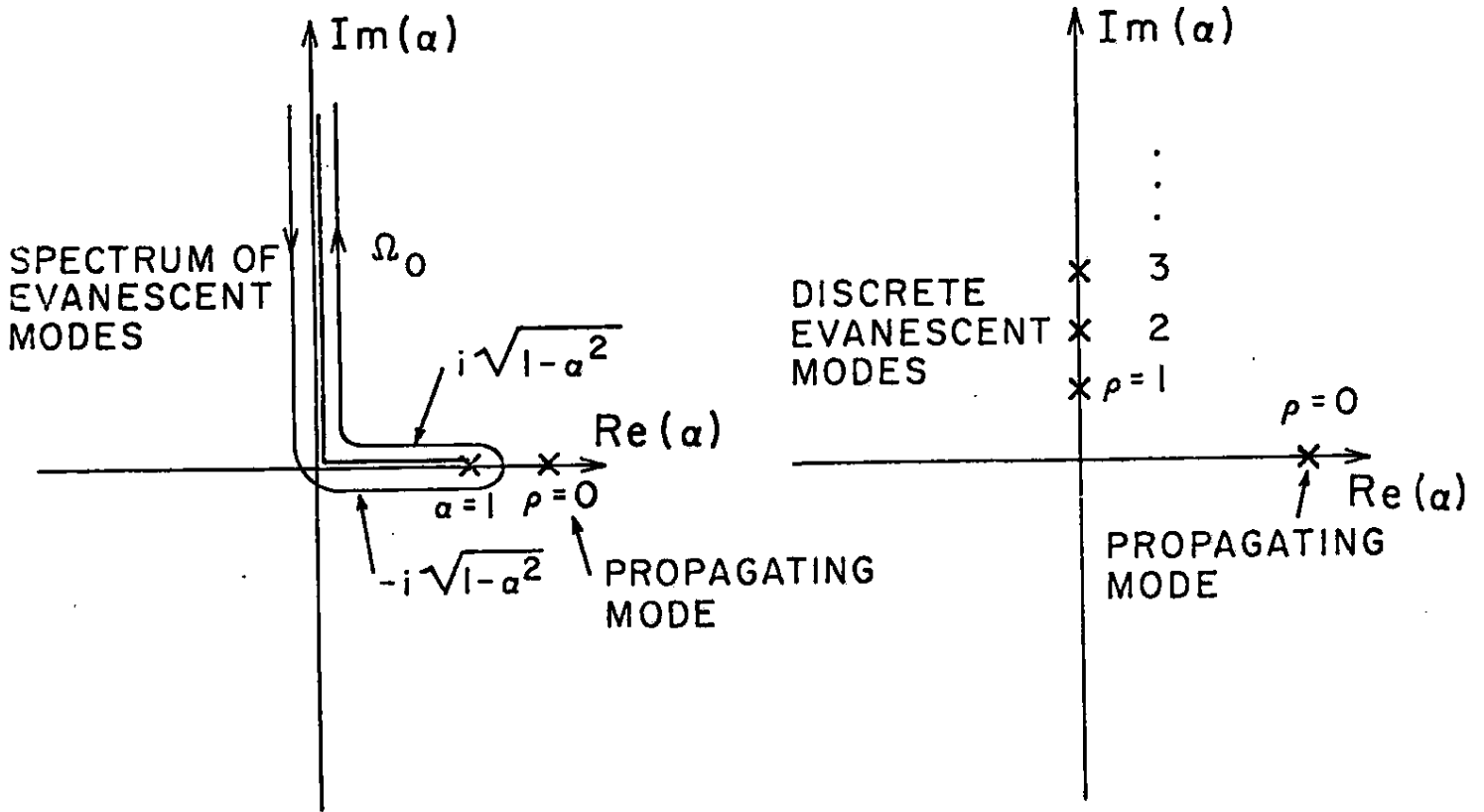

(a) LEAKY CAVITY WITH AN ANGULARLY DEPENDENT REFLECTION CO-EFFICIENT

(b) PROPAGATING AND EVANESCENT MODES FOR PERFECT MAGNETIC WALLS $\Gamma(\alpha)=1$

Figure 2

3. Field expression for the resonant mode of a rectangular patch antenna

Based upon the guided wave representation we have constructed in the previous section we now consider a rectangular patch antenna as a truncated wide microstrip of width ℓ and length h as shown in Fig.3. Clearly the resonance of such an open resonator can be viewed as a result of constructive interference of the guided modes bouncing back and forth from the two ends, i.e. $x = \pm h/2$, of the truncated structure. Now since the guided mode itself is expressible in terms of two zig-zagging plane waves of the form $\exp(ik_0\alpha_0 x \pm ik_0\xi_0 y)$ as given in (1) in the region $x > x_0$ and $\exp(-ik_0\alpha_0 x \pm ik_0\xi_0 y)$ in the region $x < x_0$, we can again utilize the reflection coefficient expression in Appendix A derived for a plane wave with the only modification of changing the angle of incidence by a 90° or according to the relationship $\xi_0 = (n^2 - \alpha_0^2)^{1/2}$ replacing $\Gamma(\alpha_0)$ by $\Gamma(\xi_0)$. Thus, if we now express the x dependence of the total guided mode field under the patch as

$$e^{ik_0(x_> - x_<)} \Rightarrow e^{ik_0\alpha_0|x-x_0|} + C e^{ik_0\alpha_0(\frac{h}{2}-x)} + D e^{ik_0\alpha_0(x+\frac{h}{2})} \quad (14)$$

We again obtain the expression for C and D by replacing the reflection coefficient as in (5,6). The result is

$$E_{z0} = \frac{4\pi A_0 \cos(k_a \xi_0 y) \cos(k_a \xi_0 y_0)}{\xi_0 \chi'(\alpha_0) + k_0 \ell \alpha_0} \left[e^{ik_0\alpha_0|x-x_0|} + \frac{2\Gamma(\xi_0) e^{ik_0\alpha_0 h}}{1 - \Gamma^2(\xi_0) e^{2ik_0\alpha_0 h}} \right. \\ \left. \times \{ \cos k_0\alpha_0(x+x_0) + \Gamma(\xi_0) e^{ik_0\alpha_0 h} \cos k_0\alpha_0(x-x_0) \} \right] \quad (15)$$

We note that since the effective dielectric constant for the guided mode of a wide microstrip is typically very close to the substrate dielectric constant so that $\xi_0 = (n^2 - \alpha_0^2)^{1/2} < 1$, the magnitude of $\Gamma(\xi_0)$ as given in

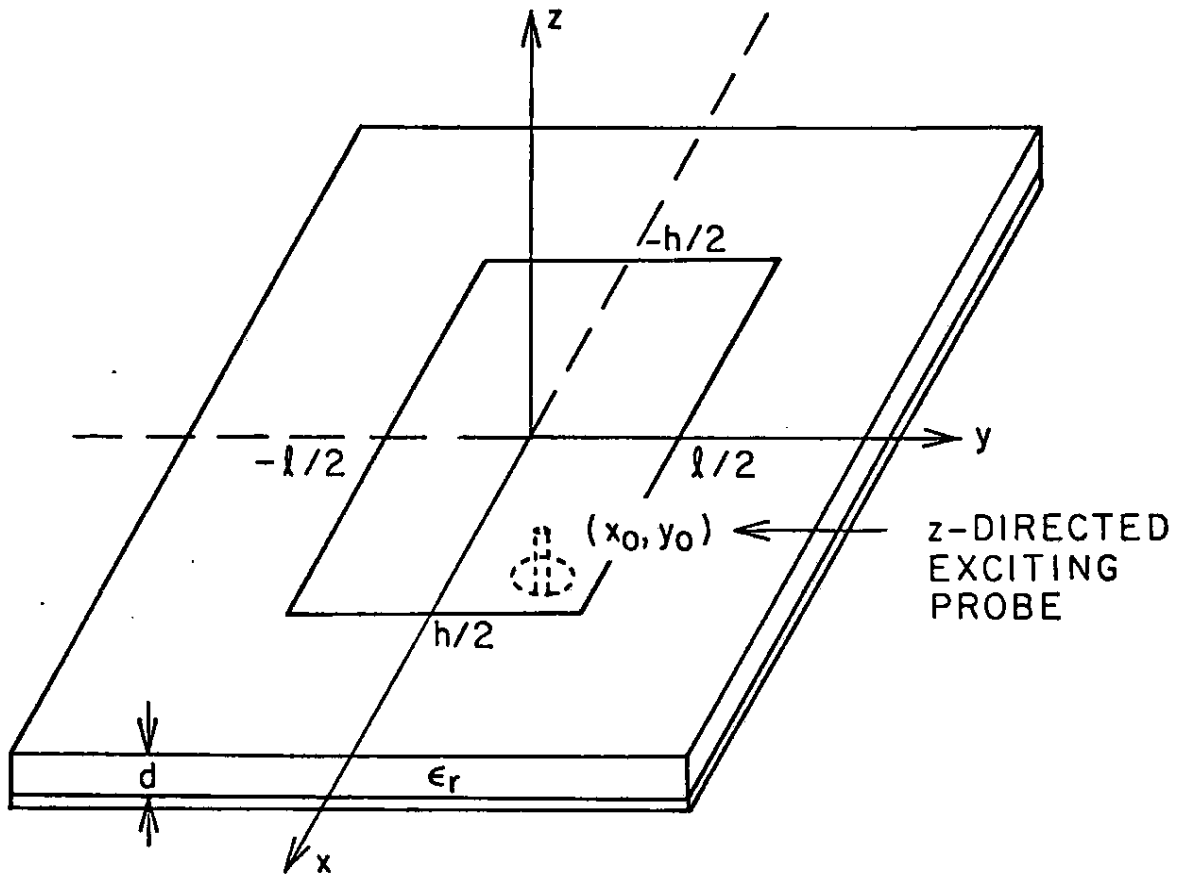

Fig. 3. Truncated microstrip patch antenna

(A.1) is always less than unity. Physically it means there will always be some radiation from the two ends of a truncated microstrip. Obviously, this interpretation of what happens at the ends and the side of a truncated microstrip is consistent with the so-called radiating and non-radiating walls in the conventional theories of the microstrip patch antennas. Different from the conventional theories, however, is that our result is dynamic in nature and self-consistent. It does not require any patch-up work to obtain our final expression given in (15).

For the case of a resonant antenna, the operating frequency is so chosen that the magnitude of the denominator is at its minimum. In other words the reflected waves have to be in phase so that for the TM_{0q} mode we have

$$k_0 \alpha_0 h - \chi(\xi_0) = q\pi ; \quad q = 1, 2, \dots \quad (16)$$

Following a similar procedure for the approximate field expression given in (12), we can show that the reactive field of the patch is given by

$$E_{zr} = \frac{2\pi A_0}{k_0 \ell} \sum_{\rho=1}^{\infty} \frac{1}{\alpha_\rho} \left[e^{ik_0 \alpha_\rho |x-x_0|} + \frac{2e^{ik_0 \alpha_\rho h}}{1 - e^{2ik_0 \alpha_\rho h}} \left\{ \cos k_0 \alpha_\rho (x+x_0) + e^{ik_0 \alpha_\rho h} \cos k_0 \alpha_\rho (x-x_0) \right\} \right] \\ \times \left[\cos \frac{p\pi}{\ell} (y+y_0) + (-1)^p \cos \frac{p\pi}{\ell} (y-y_0) \right] \quad (17)$$

Here, for simplicity, we have assumed that the reflection coefficient equals to +1 at the two ends $x = \pm h$ for all the evanescent modes under the patch.

4. Input impedance to a probe-fed rectangular microstrip patch antenna

Now that we have the field distribution under the patch, the input impedance can be found quite simply by relating the voltage $V = -E_z d$ to the current on the probe following the so-called emf method. The average tangential electric field produced by the current on the surface of the probe is given as

$$\langle E_z \rangle_a = \frac{1}{2\pi} \int_0^{2\pi} E_z(x, y) d\phi \Big|_{\substack{x = x_0 + a \cos \phi \\ y = a \sin \phi}} \quad (18)$$

Now, since the radius of the wire is assumed to be very small, i.e. $k_0 a \ll 1$, we can set $a = 0$ except for the term

$$\frac{1}{2\pi} \int_0^{2\pi} \left[\sum_{p=1}^{\infty} \frac{1}{\alpha} e^{ik_0 \alpha_p |x-x_0|} \cos\left(\frac{2p\pi y}{\ell}\right) \right] d\phi \quad (19)$$

as it represents the predominantly reactive field near the surface of the probe. It can be simplified by subtracting out first the dominant term for $p \gg 1$ and $\alpha_p \approx i \frac{2p\pi}{k_0 \ell}$ which in turn can be evaluated analytically. The details are given in Appendix C.

The input impedance to the probe fed rectangular patch antenna can be obtained as follows:

$$Z_{in} = - \frac{\langle E_z \rangle_a d}{I_0} = Z_0 - i\omega\mu L \quad (20)$$

where Z_0 , the input impedance associated with the resonant mode and L , the inductance associated with the reactive field produced by all the evanescent modes, are obtained by substituting (C.9) into (20). We have then

$$Z_0 = \frac{\omega \mu d}{(\xi_0 x'(\alpha_0) + k i \alpha_0)} \left[1 + \frac{2\Gamma(\xi_0) e^{ik_0 \alpha_0 h}}{1 - \Gamma^2(\xi_0) e^{2ik_0 \alpha_0 h}} \left\{ \cos 2k_0 \alpha_0 x_0 + \Gamma(\xi_0) e^{ik_0 \alpha_0 h} \right\} \right] \quad (21)$$

$$\begin{aligned}
L = \frac{d}{k_0 \ell} & \left[\frac{\cos 2k_0 \alpha_1 x_0 + e^{ik_0 \alpha_1 h}}{\alpha_1 \sin k_0 \alpha_1 h} + \frac{k_0 \ell}{2\pi} \cdot \frac{\text{ch}\left(\frac{4\pi x_0}{\ell}\right) + e^{-\frac{2\pi h}{\ell}}}{\text{sh}\left(\frac{2\pi h}{\ell}\right)} \right. \\
& \left. + \frac{1}{i\alpha_1} + \frac{k_0 \ell}{2\pi} \right] \\
& + \frac{d}{4\pi} \left[2 \ln \left\{ \frac{32\pi a}{\ell} \text{sh} \frac{\pi}{\ell} (h - 2x_0) \text{sh} \frac{\pi}{\ell} (h + 2x_0) \text{sh} \frac{2\pi h}{\ell} \right\} \right. \\
& \left. - \frac{2(4\pi h + a)}{\ell} + \ln 2 \right] \\
& + \delta(\alpha)
\end{aligned} \tag{22}$$

Here

$$\begin{aligned}
\delta(\alpha) = \frac{d}{k\ell} \sum_{p=2}^{\infty} & \left[\frac{\cos 2k_0 \alpha_p x_0 + e^{ik_0 \alpha_p h}}{\alpha_p \sin k_0 \alpha_p h} + \frac{k_0 \ell}{2\pi} \cdot \frac{\text{ch} \frac{4\pi x_0}{\ell} + e^{-\frac{2\pi h}{\ell}}}{\text{sh} \frac{2\pi h}{\ell}} \right. \\
& \left. + \frac{1}{i\alpha_p} + \frac{k_0 \ell}{2p\pi} \right]
\end{aligned} \tag{23}$$

Again, α_0 is the normalized propagation constant of the resonant mode as given in (9) and α_p is the normalized attenuation constant of the p^{th} evanescent mode in the patch. In (22) we have taken out the $p=1$ term from the summation in (23). $\delta(\alpha)$ can be shown to be numerically of the order of 10^{-3} for $k_0 d \ll 1$ and can indeed be ignored while calculating Z_{in} . In our analysis here we have discounted the existence of a TM_{00} mode which yields a basically uniform charge distribution on the patch and is associated with the static capacitance of the patch. This gives rise to a reactance of the form [5]

$$X_{00} = \frac{id}{\epsilon \ell h \omega} \tag{24}$$

The total input impedance would be the sum of (20) and (24).

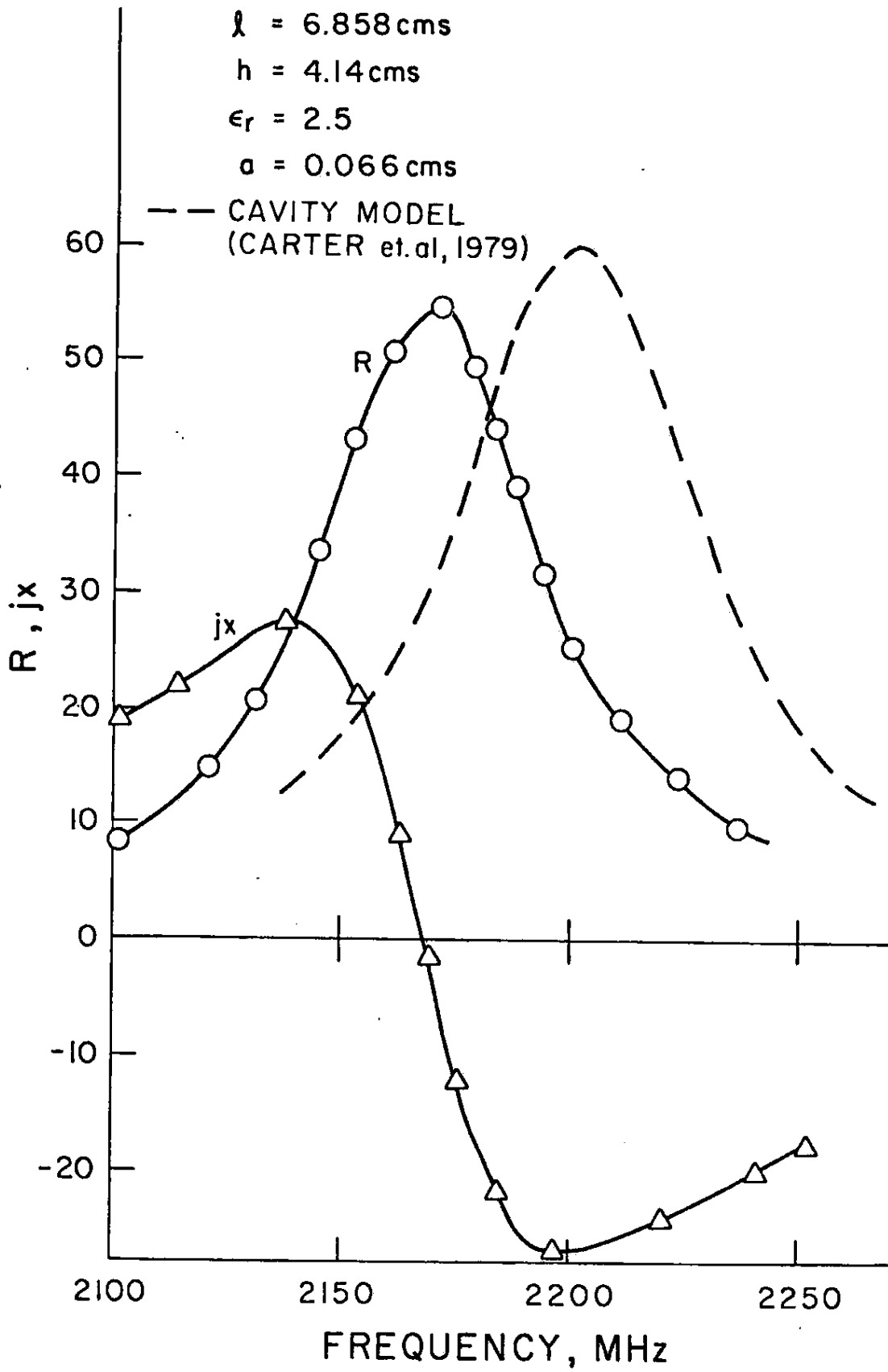

Fig. 4. Input resistance and reactance due to the propagating mode ($p=0$) as a function of frequency

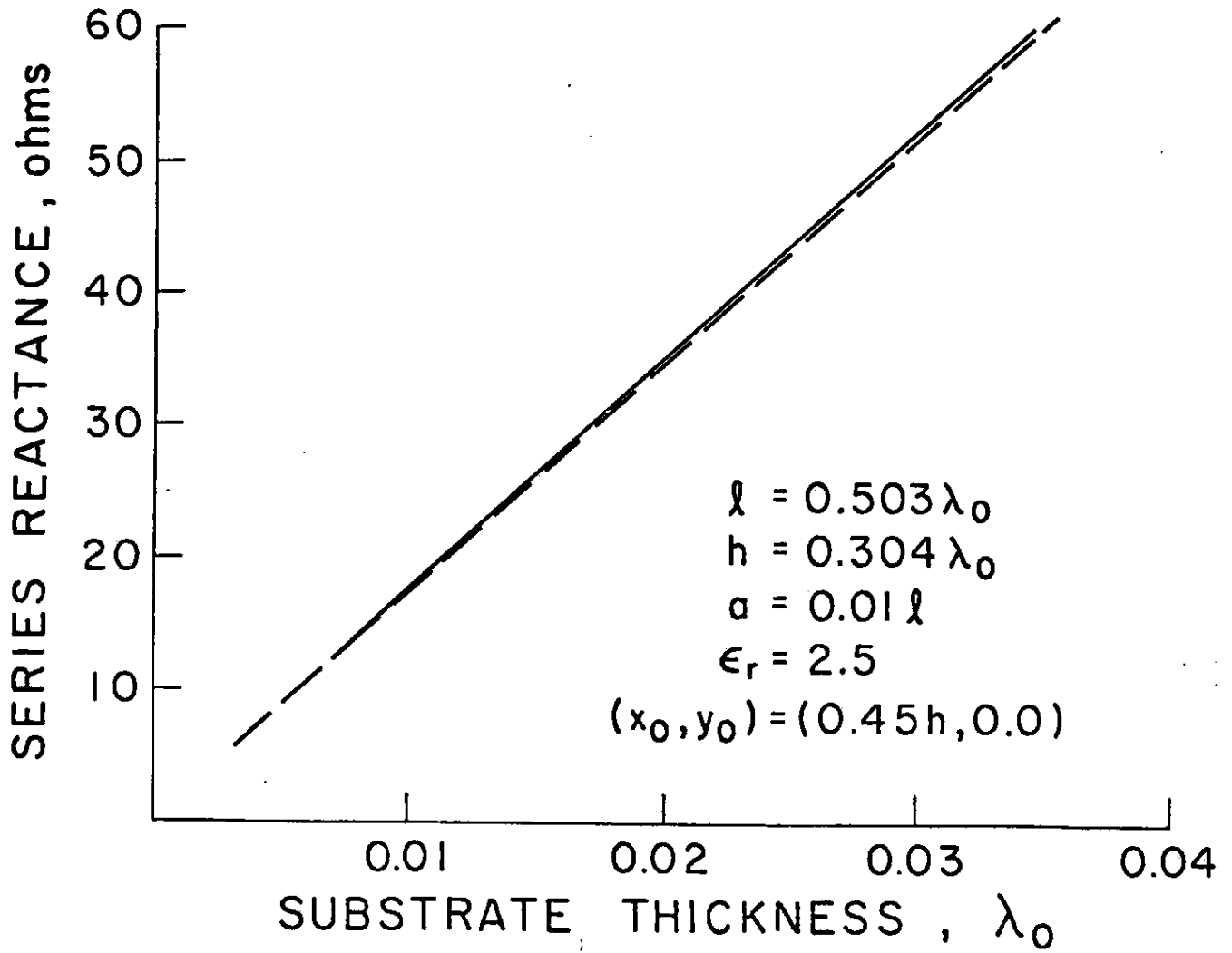

Fig. 5. Series reactance at resonance vs substrate thickness

5. Results

In Fig. 4, the input resistance and reactance due to the propagating mode of a rectangular patch of dimension $l = 6.858$ cms and $h = 4.14$ cms mounted on a grounded dielectric of thickness $d = 0.1588$ cms and $\epsilon_r = 2.5$, excited by a probe of diameter $2a = 0.132$ cms, is shown as a function of frequency and is compared with existing results [9] for a similar patch. There is a 1% difference in the resonant frequencies obtained by the two theories. The difference derives from the fact that the dynamic end susceptance as calculated from $I_m(Y)$ where

$$Y(k_0; \alpha) = Y_0 \frac{1 + \Gamma(\alpha)}{1 - \Gamma(\alpha)}, \quad (25)$$

and $Y_0 = (120\pi d/n)^{-1}$ is the characteristic admittance of the TEM wave in a parallel plate waveguide, is not linearly proportional to the operating frequency as in the conventional case where the end susceptance is typically obtained from a static assumption.

The series reactance for the same structure is shown in Fig. 5 for varying substrate thickness. Since in our formulation we have approximated the reflection coefficient to unity for the evanescent modes, we obtain the same result as that using the cavity model. However, the mathematical form of (22) is much simpler than the familiar double summation of the cavity model. In fact, (17) with a single summation of evanescent modes can be shown analytically to take the same form as that in the cavity model. This is given in Appendix D.

Figures 6 and 7 show the input resistance and reactance due to the dominant mode as the substrate thickness varies. As expected, the resonant frequency shifts and the bandwidth increases with increasing electrical thickness.

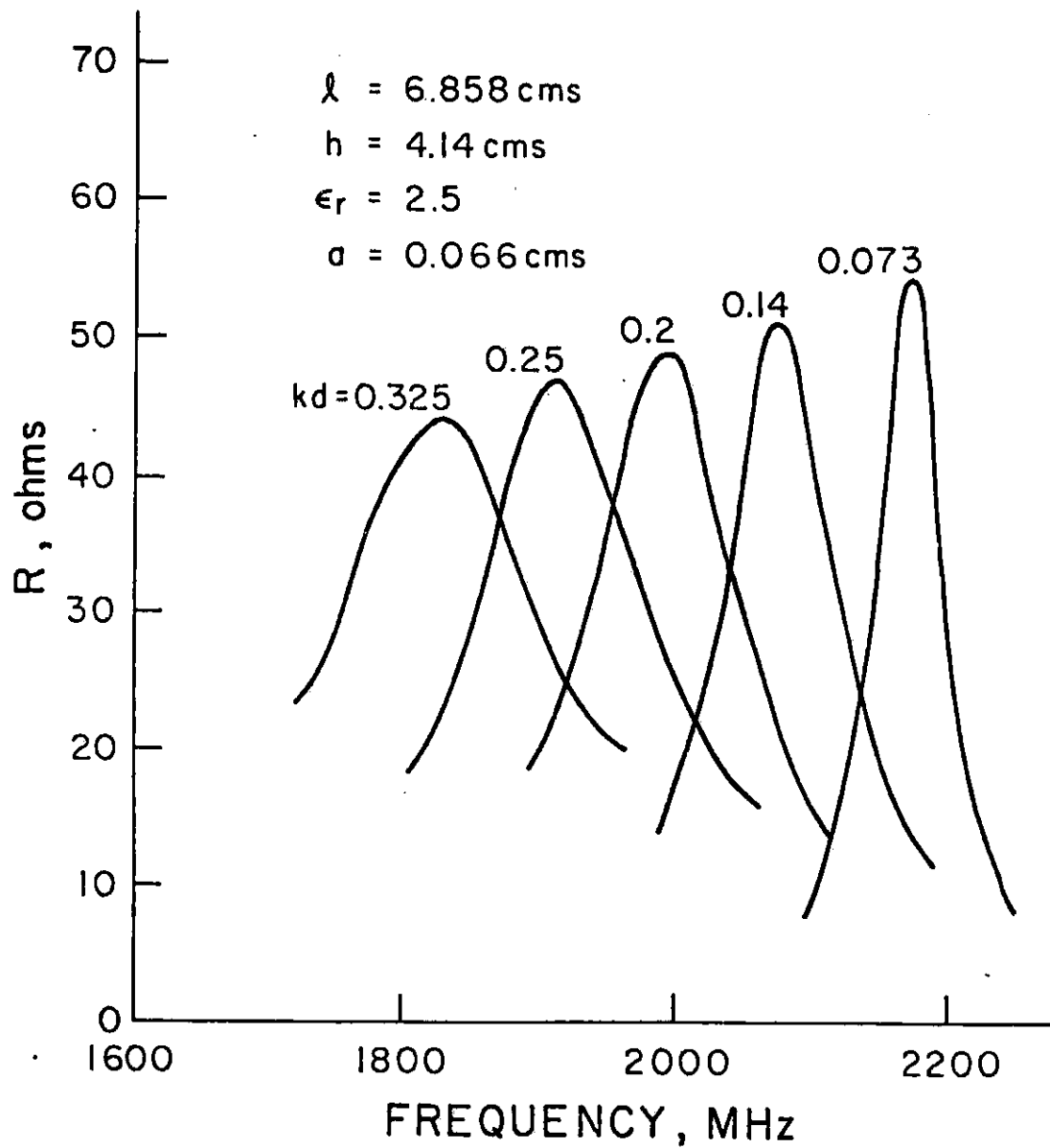

Fig. 6. Input resistance due to the propagating mode ($p = 0$) as a function of frequency

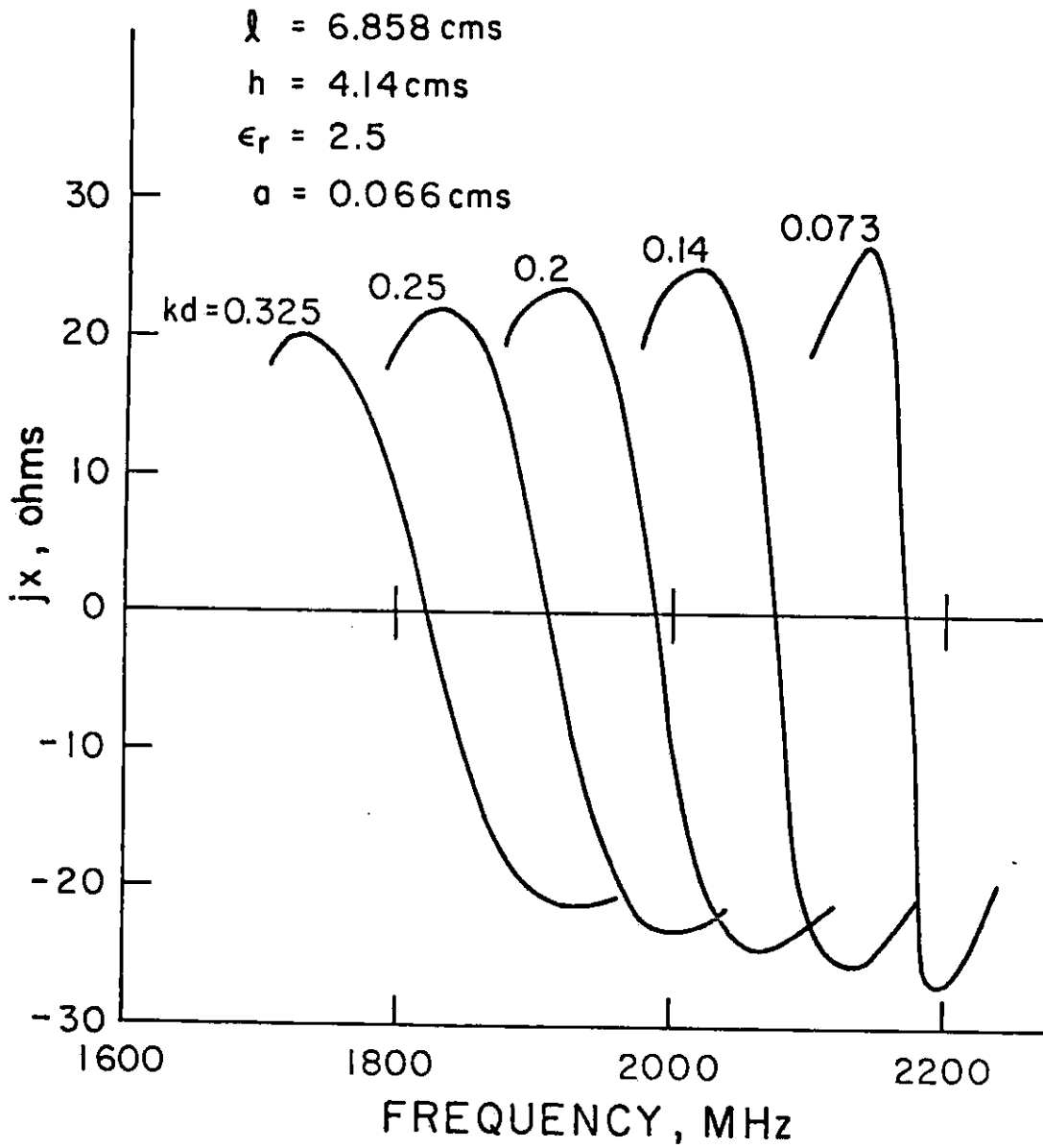

Fig. 7. Input reactance due to the propagating mode ($p=0$) as a function of frequency

6. Conclusion

An improved theory has been developed to describe the input impedance of a probe-fed rectangular microstrip patch antenna. The entire spectrum of plane waves has been considered to include both the propagating and evanescent modes. The primary feature of this theory is the dynamic nature of the resonant resistance and frequency. Further, the series reactance is expressed in a form which is much simpler for practical use. Lastly the spurious radiation has been estimated to be of the order of $k_0 d$.

References

1. Munson, R.E. "Corner fed microstrip antennas and microstrip phased arrays," IEEE Trans. Ant. Prop., Vol. AP-22, pp. 74-78, Jan. 1974.
2. Denneryd, A.G. "Linearly polarized microstrip antennas," IEEE Trans. Ant. Prop., Vol. AP-24, pp. 848-851, Nov. 1976.
3. Lo, Y.T. and Solomon D. and Richards, W.F. "Theory and experiment on microstrip antennae," IEEE Trans. Ant. Prop., AP-27, 1979, pp. 137-146.
4. Denneryd, A.G. and Lind, A.G. "Extended analysis of rectangular microstrip resonator antennas," IEEE Trans. Ant. Prop., Vol. AP-27, pp. 846-849, Nov. 1979.
5. Carver, K.R. "Input impedance to probe fed microstrip antennas," Proc. Int. Symp. Ant. Prop. June 1980, Seattle, WA.
6. Chang, D.C. "Analytical theory of an unloaded rectangular microstrip patch," IEEE Trans. Ant. Prop., Vol. AP-29, No. 1, Jan. 1981, pp. 54-62.
7. Chang, D.C. and Kuester, E.F. "Total and partial reflection from the end of a parallel plate waveguide with an extended dielectric slab," Rad. Sci. Vol. 16, No. 1, pp. 1-13, Jan.-Feb., 1981.
8. Kuester, E.F., Johnk, R.T. and Chang, D.C. "The thin substrate approximation for reflection from the end of a slab-loaded parallel plate waveguide with application to microstrip patch antennas," To be published, AP 1982.
9. Carver, K.R. and Coffey, E.L. "Theoretical investigation of the microstrip antenna," Phy. Sci. Lab., New Mexico State Univ., Las Cruces, N.M., Technical Report PT-00929, Jan. 23, 1979.

APPENDIX

A. Angularly dependent reflection coefficient

$\Gamma(\alpha)$ is the complex reflection coefficient of the plane waves bouncing in the y -direction when these waves proceed from the exciting probe and are incident on the walls $y = \pm \ell/2$. Whether or not they radiate into space depends upon the angle of incidence $\phi = \sin^{-1}(\alpha/n)$. Beyond this critical angle the reflection coefficient has a magnitude of unity. The analytical closed form expression for $\Gamma(\alpha)$ from [8] is repeated here.

$$\Gamma(\alpha) = e^{-i\chi(\alpha)} \quad (\text{A.1})$$

where

$$\chi(\alpha) = 2 \tan^{-1} \left(\frac{\alpha}{\sqrt{(n^2 - \alpha^2)}} \tanh \Delta \right) - f_e \left(-\sqrt{n^2 - \alpha^2} \right) \quad (\text{A.2})$$

$$\Delta(\alpha) \approx \frac{k_0 d \alpha}{\pi} \left\{ \left(\frac{1}{\epsilon_r} - \mu_r \right) \left[\ln(\sqrt{\alpha^2 - 1} k_0 d) + \gamma - 1 \right] + 2Q_0(-\delta_\epsilon) - 2Q_0(\delta_\mu) \right\} \quad (\text{A.3})$$

$$f_e \left(-\sqrt{n^2 - \alpha^2} \right) \approx \frac{-2\sqrt{n^2 - \alpha^2} k_0 d}{\pi} \left\{ \frac{1}{\epsilon_r} \left[\ln(\sqrt{\alpha^2 - 1} k_0 d) + \gamma - 1 \right] + 2Q_0(-\delta_\epsilon) - \ln 2\pi \right\} \quad (\text{A.4})$$

when $\alpha \approx n$, Δ is very small and

$$\chi(\alpha) \approx \frac{2k_0 d}{\pi\sqrt{n^2 - \alpha^2}} \left[(1 - \alpha^2) \mu_r \left\{ \ln(\sqrt{\alpha^2 - 1} k_0 d) + \gamma - 1 \right\} + 2n^2 \{ 2Q_0(-\delta_\epsilon) - \ln 2\pi \} - \alpha^2 \{ 2Q_0(\delta_\mu) - \ln 2\pi \} \right] \quad (\text{A.5})$$

$$\delta_\epsilon = \frac{\epsilon_r - 1}{\epsilon_r + 1} ; \quad \delta_\mu = \frac{\mu_r - 1}{\mu_r + 1} ; \quad Q_0(z) = \sum_{m=1}^{\infty} z^m \ln m \quad (\text{A.6})$$

B. Analysis of the evanescent modes and estimation of the spurious radiation

The branch cut integration along Ω_0 in Fig. 2a obtained by deforming the field expression E_z in (7) gives the spectrum of evanescent modes in the range 0 to $i\infty$ and the spurious radiation in the range 0 to 1.

Rewriting (7) for convenience we have

$$E_{zr} = \int_{\Omega_0} \frac{d\alpha}{\sqrt{n^2 - \alpha^2}} e^{ik_0\alpha(x_> - x_<)} \left[e^{i\xi k_0(y_> - y_<)} + \frac{2\Gamma(\alpha)e^{i\xi k_0\ell}}{1 - \Gamma^2(\alpha)e^{i2\xi k_0\ell}} \right. \\ \left. \{ \cos k_0(y + y_0) + \Gamma(\alpha)e^{i\xi\ell} \cos k_0\xi(y - y_0) \} \right] \quad (B.1)$$

In this region the reflection coefficient is complex and is given by

$$\Gamma(\alpha) = e^{-i(\chi_r \mp i\lambda)} \quad \text{where } \chi_r \text{ is the real part and the imaginary part } \lambda$$

is given by

$$\lambda = \frac{k_0 d}{\xi} (1 - \alpha^2) \quad (B.2)$$

and the \mp signs denote its value on the two sides of the branch

cut. Simplifying (B.1) on the two sides therefore we have

$$E_{zr} = \int_{\Omega_0} \frac{d\alpha}{\sqrt{n^2 - \alpha^2}} e^{ik_0\alpha(x_> - x_<)} \frac{\cos(\xi k_0\ell - \chi_r) \text{sh } \lambda}{[\sin(\xi k_0\ell - \chi_r) \text{ch } \lambda]^2 + [\cos(\xi k_0\ell - \chi_r) \text{sh } \lambda]^2} \quad (B.3)$$

For integration along the imaginary ones from 0 to $i\infty$ for convenience

we subdivide the range

$$i\alpha = i(\text{Im}[\alpha'_p] + \tau) \quad (B.4)$$

where $\text{Im}(\alpha'_p)$ is the imaginary part of α'_p determined from the equation

$$(n^2 + \alpha'^2_p)^{\frac{1}{2}} k_0\ell - \chi(i\alpha'_p) = p\pi, \quad p = 1, 2, \dots \quad (B.5)$$

Using (B.4) we have the following relations

$$\xi = \sqrt{n^2 - \alpha^2} = \sqrt{n^2 + \alpha'^2_p + 2\alpha'_p\tau + \tau^2} \approx \xi'_p + \frac{\alpha'_p\tau}{\xi_p} \quad (B.6)$$

where

$$\xi'_p = \sqrt{n^2 + \alpha_p'^2} .$$

Since the contribution to the value of the integral is primarily in the vicinity of α_p' we can use the small order approximation to obtain

$$\cos(\xi k_0 \ell - \chi_r) \approx (-1)^p \quad (B.7)$$

and

$$\sin(\xi k_0 \ell - \chi_r) \approx (-1)^p \left(\frac{\alpha_p' k_0 \ell}{\xi'_p} \right) \tau \quad (B.8)$$

Substituting (B.6) through (B.8) in (B.3) we have

$$E_{zr} \approx \sum_p \frac{1}{2\alpha_p' \ell} e^{-k_0 \alpha_p' (x_> - x_<)} (-1)^p \{ \cos k_0 \xi'_p (y+y_0) + (-1)^p \cos \xi'_p (y-y_0) \} \int_0^\infty \frac{2i\epsilon}{\tau^2 + \epsilon^2} d\tau \quad (B.9)$$

where

$$\epsilon = \frac{\xi'_p \lambda}{\alpha_p' \ell k_0} .$$

If we change the variable of integration as

$$\tau = \epsilon \tan \theta ,$$

(B.9) can be simplified to obtain the following results:

$$E_{zr} \approx \sum_p \frac{2\pi i A_0}{\alpha_p' \ell} e^{-k_0 \alpha_p' (x_> - x_<)} (-1)^p \left[\cos k_0 \xi'_p (y+y_0) + (-1)^p \cos k_0 \xi'_p (y-y_0) \right] \quad (B.10)$$

For the case of perfect magnetic walls, however, $\chi = 0$ and with a similar simplification we can show without difficulty that (B.9) now becomes

$$E_{zr} \approx \sum_p \frac{2\pi i A_0}{\alpha_p' \ell} e^{-k_0 \alpha_p' (x_> - x_<)} (-1)^p [\cos \xi_p k_0 (y+y_0) + (-1)^p \cos \xi_p k_0 (y-y_0)] \quad (B.11)$$

Here α_p is obtained from

$$k_0 \sqrt{n^2 + \alpha_p^2} \ell = p\pi \quad (B.12)$$

and

$$\xi_p = \sqrt{n^2 + \alpha_p^2}$$

Hence for both the cases, $\Gamma(\alpha) = e^{-i\chi}$ and $\Gamma(\alpha) = 1$, the same formula is obtained. The difference is in α_p and α'_p and from (B.2) it can be seen that this difference is of the order of $k_0 d$ and is, therefore, immaterial for integration along the imaginary axis. As a result we can make $\Gamma(\alpha) = 1$ for the evanescent modes.

Considering now the integral from 0 to 1 and inspecting (B.2) and (B.3) we see that the integration would be of the order of $k_0 d$ provided $\xi \ell < \pi$. However, at resonance since the resonant term is of the order of $1/k_0 d$, the spurious radiation can be ignored as far as the input impedance is concerned.

C. Averaging the field over the area of the probe

The integration indicated in (18) gives the average field over the area of the probe. On inspection of (15) and (17) we note that only one term is divergent and it is given by

$$A_0 \frac{2}{k_0 \ell} \int_0^{2\pi} \sum_{p=1}^{\infty} \left[\frac{1}{\alpha_p} e^{ik_0 \alpha_p a |\sin \phi|} \cos \frac{2p\pi}{\ell} y \right] d\phi \quad (C.1)$$

The integration with respect to ϕ need be performed for only this term. For all other convergent terms, since the higher order terms of the Taylor series expansion are of the order of $k_0 a$ where a is the radius of the probe we can approximate $x \approx x_0$ and $y \approx y_0$. In contrast the diverging terms would be of the form of $\ln(k_0 a)$ so that the higher order terms of the Taylor series would approach ∞ with $a = 0$ and hence the integration becomes necessary in this case. We further consider a particular case of the probe centered along the width of the patch, i.e. $y_0 = 0$, in which case only the even order modes would be excited and p can be replaced by $2p$.

To evaluate (C.1) now, we first subtract out the dominant part of the series, when p is large and $\alpha_p \approx i \frac{2p\pi}{k_0 \ell}$, which would be as follows:

$$-2iA_0 \int_0^{2\pi} \left[\sum_{p=1}^{\infty} \frac{1}{p} e^{-\frac{2p\pi}{\ell} a |\sin\phi|} \cos\left(\frac{2p\pi}{\ell} a \cos\phi\right) d\phi \right] \quad (C.2)$$

and once again for the remaining part of (C.1) we can use the approximation $x = x_0$, $y = 0$ and with $a/\ell \ll 1$ this part becomes

$$\frac{4\pi i A_0}{k_0 \ell} \sum_{p=1}^{\infty} \left[\frac{1}{i\alpha_p} + \frac{k_0 \ell}{2\pi} \right] \quad (C.3)$$

Considering (C.2) now, the series can be evaluated analytically by using standard summation formulae upon which the integration with respect to ϕ becomes trivial and (C.2) takes the following form

$$iA_0 \left[\ln\left(\frac{8\pi^2 a^2}{\ell^2}\right) - \frac{2a}{\ell} \right] \quad (C.4)$$

The second term in the summation of (17) with $x \approx x_0$ and $y = 0$ is given by

$$i \frac{4\pi A_0}{k_0 \ell} \sum_{p=1}^{\infty} \left[\frac{\cos(2k_0 \alpha_p x_0) + e^{ik_0 \alpha_p h}}{\alpha_p \sin \alpha_p k_0 h} \right] \quad (C.5)$$

This series can be made into a rapidly converging one by once again extracting out the term for p large. This would give the following

$$\begin{aligned} & \frac{4\pi i A_0}{k_0 \ell} \sum_{p=1}^{\infty} \left[\frac{\cos 2k_0 \alpha_p x_0 + e^{ik_0 \alpha_p h}}{\alpha_p \sin k_0 \alpha_p h} + \frac{k_0 \ell}{2\pi} \frac{\operatorname{ch} \frac{4\pi x_0}{\ell} + e^{-\frac{2p\pi h}{\ell}}}{\operatorname{sh}\left(\frac{2p\pi h}{\ell}\right)} \right] \\ & - 2iA_0 \sum_{p=1}^{\infty} \frac{1}{p} e^{-\frac{2p\pi}{\ell}(h-2x_0)} - 2iA_0 \sum_{p=1}^{\infty} \frac{1}{p} e^{-\frac{2p\pi}{\ell}(h+2x_0)} \\ & - 2iA_0 \sum_{p=1}^{\infty} \frac{1}{p} e^{-\frac{4p\pi h}{\ell}} \end{aligned} \quad (C.6)$$

The last three terms can be summed analytically. The average field over the area of the probe, obtained by using (15), where $x \approx x_0$ and $y \approx 0$, and (C.3) through (C.6) is given as follows:

$$\begin{aligned}
\langle E_z \rangle_a = & \frac{A_0 4\pi}{(\xi \chi'(\alpha) + k_0 \ell \alpha_0)} \left[1 + \frac{2\Gamma(\xi_0) e^{ik_0 \alpha_0 h}}{1 - \Gamma^2(\xi_0) e^{i2k_0 \alpha_0 h}} \left\{ \cos 2k_0 \alpha_0 x_0 + \Gamma(\xi_0) e^{ik_0 \alpha_0 h} \right\} \right. \\
& + iA_0 \left[2 \ln \left\{ \frac{32\pi a}{\ell} \operatorname{sh} \frac{\pi}{\ell} (h - 2x_0) \operatorname{sh} \frac{\pi}{\ell} (h + 2x_0) \operatorname{sh} \left(\frac{2\pi h}{\ell} \right) \right\} \right. \\
& + \frac{4\pi i A_0}{k_0 \ell} \sum_{\rho=1}^{\infty} \left[\frac{\cos 2k_0 \alpha_p x_0 + e^{ik_0 \alpha_p h}}{\alpha_p \sin k_0 \alpha_p h} + \frac{k_0 \ell \operatorname{ch} \left(\frac{4\rho\pi x_0}{\ell} \right) + e^{-\frac{2\rho\pi h}{\ell}}}{2\pi \operatorname{sh} \left(\frac{2\rho\pi h}{\ell} \right)} \right. \\
& \left. \left. + \frac{1}{i\alpha_p} + \frac{k_0 \ell}{2\rho\pi} \right] \right] \quad (C.7)
\end{aligned}$$

D. The limiting case of perfect magnetic walls as a comparison to the cavity model

The purpose of this section is to show that in the limit of perfect magnetic walls this theory reduces to the cavity model where the field is given by the sum of all modes in the x and y directions. For such a cavity with $\Gamma(\alpha) = 1 = \Gamma \sqrt{n^2 - \alpha^2}$ in (15) and (17) the electric field under the patch may be obtained. However in order to show a more explicit comparison with the cavity model we try to make the single summation that we have here into a double summation as follows:

In (17) denoting,

$$\begin{aligned}
\phi(\alpha) = & \left[e^{ik_0 \alpha_p (x_> - x_<)} + \frac{2e^{ik_0 \alpha_p h}}{1 - e^{i2k_0 \alpha_p h}} \left\{ \cos k_0 \alpha_p (x + x_0) \right. \right. \\
& \left. \left. + e^{ik_0 \alpha_p h} \cos k_0 \alpha_p (x - x_0) \right\} \right]
\end{aligned}$$

we note that $\phi(\alpha)$ should satisfy a wave equation of the form

$$\left(\frac{d^2}{dx^2} + k_{\alpha}^2 \right) \phi(\alpha) = -ik_{\alpha} \delta(x - x_0) \quad (D.1)$$

and the boundary condition

$$\phi'(\alpha) = 0 \quad \text{at} \quad x = \pm h/2 .$$

Assuming a solution of the form

$$\phi(\alpha) = \sum_n A_n \cos\left(\frac{n\pi}{h/2} x\right) \quad \text{for } n = 1, 2 \dots \quad (\text{D.2})$$

which satisfies the orthogonality relation

$$\int_{-h/2}^{h/2} \left[A_m \cos\left(\frac{m\pi}{h/2} x\right) \sum_n A_n \cos\left(\frac{n\pi x}{h/2}\right) \right] dx = \text{constant} \quad (\text{D.3})$$

for $m = n$

and substituting (D.3) into (D.1) we have

$$A_m = -i \frac{2k\alpha\pi}{h} \left[\frac{1}{k_o^2 \alpha^2 - \left(\frac{2m\pi}{h}\right)^2} \right] \cos\left(\frac{2m\pi}{h} x_o\right) \quad (\text{D.4})$$

and then substituting (D.4) into (D.2) gives

$$\phi(\alpha) = -i \frac{2k\alpha\pi}{h} \sum_m \frac{1}{k_o^2 \alpha^2 - \left(\frac{2m\pi}{h}\right)^2} \cos\left(\frac{2m\pi x}{h}\right) \cos\left(\frac{2m\pi}{h} x_o\right) \quad (\text{D.5})$$

Substituting for $\phi(\alpha)$ in (10) and (11) for the even order modes the electric field distribution under the truncated microstrip patch is given by

$$E_z = -i \frac{8\pi^2 A_o}{\ell h} \sum_p \sum_m \frac{\cos\left(\frac{2p\pi}{\ell} y_o\right) \cos\left(\frac{2p\pi}{\ell} y\right) \cos\left(\frac{2m\pi}{h} x_o\right) \cos\left(\frac{2m\pi}{h} x\right)}{k^2 n^2 - \left(\frac{2p\pi}{\ell}\right)^2 - \left(\frac{2m\pi}{h}\right)^2} \quad (\text{D.6})$$

In order to average the field over the area of the probe we integrate (D.6)

with respect to ϕ as follows:

$$\langle E_z \rangle_a = i \frac{w_l I_o}{\ell h} \sum_p \sum_m \left[\frac{\cos\left(\frac{2p\pi}{\ell} y_o\right) \cos\left(\frac{2m\pi}{h} x_o\right)}{k^2 n^2 - \left(\frac{2p\pi}{\ell}\right)^2 - \left(\frac{2m\pi}{h}\right)^2} \int_0^{2\pi} \cos\left(\frac{2m\pi}{h} (x_o + a \cos \phi)\right) \cos\left(\frac{2p\pi}{\ell} (y_o + a \sin \phi)\right) d\phi \right] \quad (\text{D.7})$$

where A_o is given in (2).

Performing the integration and substituting in (20), the input impedance is given by

$$Z_{in} = -i \frac{\omega_0 d}{\ell h} \sum_p \sum_m \frac{\cos^2\left(\frac{2p\pi}{\ell} y_0\right) \cos^2\left(\frac{m\pi}{h} x_0\right)}{k_n^2 - \left(\frac{2p\pi}{\ell}\right)^2 - \left(\frac{2m\pi}{h}\right)^2} J_0\left(\sqrt{\left(\frac{2m\pi}{h}\right)^2 + \left(\frac{2p\pi}{\ell}\right)^2} a\right) \quad (D.8)$$

The modes corresponding to p and m are the same as that obtained in the cavity model [5] with $J_0\left(\sqrt{\left(\frac{2m\pi}{h}\right)^2 + \left(\frac{2p\pi}{\ell}\right)^2} a\right)$ corresponding to the converging factor G_{mn} .