

Spring 3-1-1980

# Resonance Characteristics of a Rectangular Microstrip Antenna

David C. Chang  
*University of Colorado Boulder*

Follow this and additional works at: <https://scholar.colorado.edu/elmimi>

---

## Recommended Citation

Chang, David C., "Resonance Characteristics of a Rectangular Microstrip Antenna" (1980). *Electromagnetics Laboratory/The MIMICAD Research Center*. 73.  
<https://scholar.colorado.edu/elmimi/73>

This Technical Report is brought to you for free and open access by Electrical, Computer & Energy Engineering at CU Scholar. It has been accepted for inclusion in Electromagnetics Laboratory/The MIMICAD Research Center by an authorized administrator of CU Scholar. For more information, please contact [cuscholaradmin@colorado.edu](mailto:cuscholaradmin@colorado.edu).

Scientific Report No. 51  
RESONANCE CHARACTERISTICS OF A RECTANGULAR  
MICROSTRIP ANTENNA\*

by

David C. Chang and Edward F. Kuester

March 1980

Electromagnetics Laboratory  
Department of Electrical Engineering  
University of Colorado  
Boulder, Colorado 80309

\*This work is supported by NSF under Grant No. 7809029.  
Dr. E. Schutzman is the Program Monitor.

# RESONANCE CHARACTERISTICS OF A RECTANGULAR MICROSTRIP ANTENNA

D.C. CHANG AND E.F. KUESTER  
ELECTROMAGNETICS LABORATORY  
DEPARTMENT OF ELECTRICAL ENGINEERING  
UNIVERSITY OF COLORADO  
BOULDER, COLORADO 80309

## SUMMARY

A graphical method for determining the size of a resonant, rectangular microstrip patch for a specified frequency is given. Using an expression obtained from the reflection coefficient of a TEM-wave in a semi-infinite microstrip patch, the resonance condition of a given mode for a patch of finite size, is derived in a manner analogous to that of a rectangular, waveguide cavity. Radiation is shown to be in the form of both surface-waves and sky-waves, and is dependent of the angles of incident for waves impinging onto the edges of the patch. By varying the aspect ratio, it is also possible to modify the Q-factor of a resonant patch.

## 1.0 INTRODUCTION

In the design of a microstrip patch antenna, it is sometimes necessary to consider the trade-offs regarding the aspect ratio of the patch. For instance, to what extent one can enhance the radiation from a patch antenna operating near resonance by adjusting its aspect ratio, is ultimately related to the efficiency of such an antenna. It is our purpose in this paper to provide some physical insights into the radiation mechanism of a microstrip patch antenna by examining in detail the canonical problem of a TEM-wave incident obliquely from inside the region of a semi-infinite patch placed on the surface of a grounded dielectric slab. From an analogy of this type of antenna to that of a resonant rectangular waveguide cavity, condition for the resonance of a given mode is derived. Provided that the edge effect from all four edges can be separated, our method yields

explicitly design criteria for devising a low Q-antenna. In the process, some of the misconceptions regarding the role of surface-wave and sky-wave, the dynamic nature of the end-admittance, etc. also will be clarified.

## 2.0 ANOTHER LOOK ON THE RESONANCE OF A RECTANGULAR WAVEGUIDE CAVITY

Since the electromagnetic field associated with a microstrip patch antenna typically is concentrated in the region between the patch and the ground plane, it is not unreasonable to expect that such an antenna operating near its resonance is similar to a resonant rectangular waveguide cavity [1-3]. It is well-known that the resonant frequency of the  $TE_{q,p,0}$ -mode in a cavity having a dimension of  $2h \times 2\ell \times d$  (meters)<sup>3</sup>, and filled with a lossless dielectric material of permittivity  $\epsilon_1$  and permeability  $\mu$  (Fig.1), is governed by the following equation [4].

$$\omega(\mu\epsilon_1)^{\frac{1}{2}} = \left[ \left( \frac{2p-1}{2\ell} \pi \right)^2 + \left( \frac{2q-1}{2h} \pi \right)^2 \right]^{\frac{1}{2}} ; \quad p, q = 1, 2, 3, \dots \quad (1)$$

where  $\omega = 2\pi f$  is the angular frequency of an even mode. (The modes of interest here are restricted to those having no variation in the z-direction). Equation (1) can be used to determine the resonant frequency of a  $q$  p<sup>th</sup> mode once  $h$  and  $\ell$  are known, or alternatively, the aspect ratio  $h/\ell$ , if both  $\omega$  and  $\ell$  are specified. However, it provides no clue as to how the resonance of a cavity can be effected if the boundary condition on one or more waveguide walls are somehow modified.

In order to examine the resonance phenomenon in more detail, we consider first the propagation of individual plane waves in such a cavity. Assuming for the moment a TE-wave of the form

$$E_z^{inc} = E_0 \exp\{-ik_0[\alpha x + (n^2 - \alpha^2)^{\frac{1}{2}} y]\} \exp(i\omega t) \quad (2)$$

where  $k_0 = \omega(\mu\epsilon_0)^{\frac{1}{2}}$  is the free-space wave number and  $n = (\epsilon_1/\epsilon_0)^{\frac{1}{2}}$  is the refractive index of the dielectric material, is incident onto the wall on the left in Fig. 1, i.e.,  $y = 0$ ;  $0 < z < d$ , at an angle  $\phi = \sin^{-1}(\alpha/n)$  with respect to the y-axis, we can obtain without any difficulty, the form of the reflected wave as

$$E_z^r = E_0 \Gamma(\alpha) \exp\{-ik_0[\alpha x - (n^2 - \alpha^2)^{\frac{1}{2}} y]\}$$

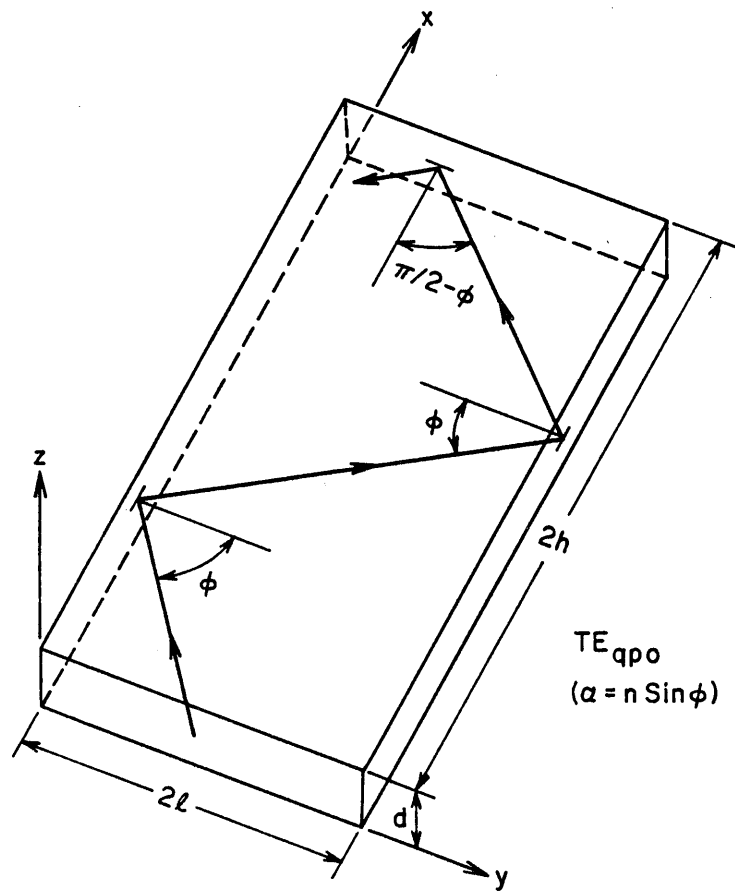

Fig. 3. Geometry of a rectangular microstrip patch

where  $\Gamma(\alpha) = |\Gamma| \exp(i\chi)$  is defined as the Fresnel reflection coefficient of a plane wave incidence. For a perfectly-conducting wall,  $\Gamma(\alpha) = -1$  and  $\chi(\alpha) = -\pi$ , and for a more general case when the wall is lined with some constant impedance surface, the magnitude of  $\Gamma$ , i.e.  $|\Gamma|$  is typically equal or less than unity. Thus, for a wave zig-zagging between the two side walls at  $y = 0$  and  $y = 2\ell$ , a constructive interference can occur only if the total phase change after a complete bounce equals to integer multiple of  $4\pi$  for an even distribution,

$$2k_0 \ell (n^2 - \alpha^2)^{\frac{1}{2}} - \chi(\alpha) = 2p\pi ; \quad p = 1, 2, \dots \quad (3)$$

A transverse resonance is said to have been achieved when this condition is met. Alternatively, we can write with a superscript  $y$

$$k_0 \ell = \mathcal{F}_p^{(y)}, \quad \mathcal{F}_p^{(y)}(\alpha) = [2p\pi + \chi^{(y)}(\alpha)] / 2(n^2 - \alpha^2)^{\frac{1}{2}} ; \quad p = 1, 2, \dots \quad (4)$$

Again,  $\chi^{(y)} = -\pi$  for a perfectly-conducting wall. Obviously, the same situation exists in the  $x$ -direction, with the only exception that the incident angle is now  $\pi/2 - \phi$  instead of  $\phi$ . Thus, by replacing  $\alpha$  with  $(n^2 - \alpha^2)^{\frac{1}{2}}$ , we obtain the transverse resonance in the  $x$ -direction as

$$k_0 h = \mathcal{F}_q^{(x)}, \quad \mathcal{F}_q^{(x)}(\alpha) = [2q\pi + \chi^{(x)}(\alpha)] / 2\alpha ; \quad q = 1, 2, \dots \quad (5)$$

Elimination of  $\alpha$  from (4) and (5) yields immediately the governing equation in (1) for a perfectly-conducting cavity where  $\chi^{(x)} = \chi^{(y)} = -\pi$ . However, it is not possible to achieve this if either  $\chi^{(x)}$  or  $\chi^{(y)}$  is a function of the incident angle  $\phi$  and hence,  $\alpha$ . Instead, we have to resort to graphical methods in that event. As an example, Fig. 2 shows the function  $\mathcal{F}_p^{(y)}(\alpha)$ ;  $p = 1, 2$  for the case of a lossless waveguide cavity filled with a dielectric material  $\epsilon_1 = 4\epsilon_0$ , as  $\alpha$  varies from 0 to 2.

We can now use Fig. 2 to demonstrate how one can determine the acceptable aspect ratios of a cavity, once the desirable resonant frequency is specified. For instance, if our interest is to find the value of  $h/\ell$  for a resonant  $TE_{210}$ -mode when  $k_0 \ell$  is chosen to be 1.5, we first determine from the  $p = 1$  curve that the value of  $\alpha$  has to be  $\alpha = \alpha_y = 1.69$  in order to achieve a transverse resonance in the  $y$ -direction. The resultant wave then zig-zags

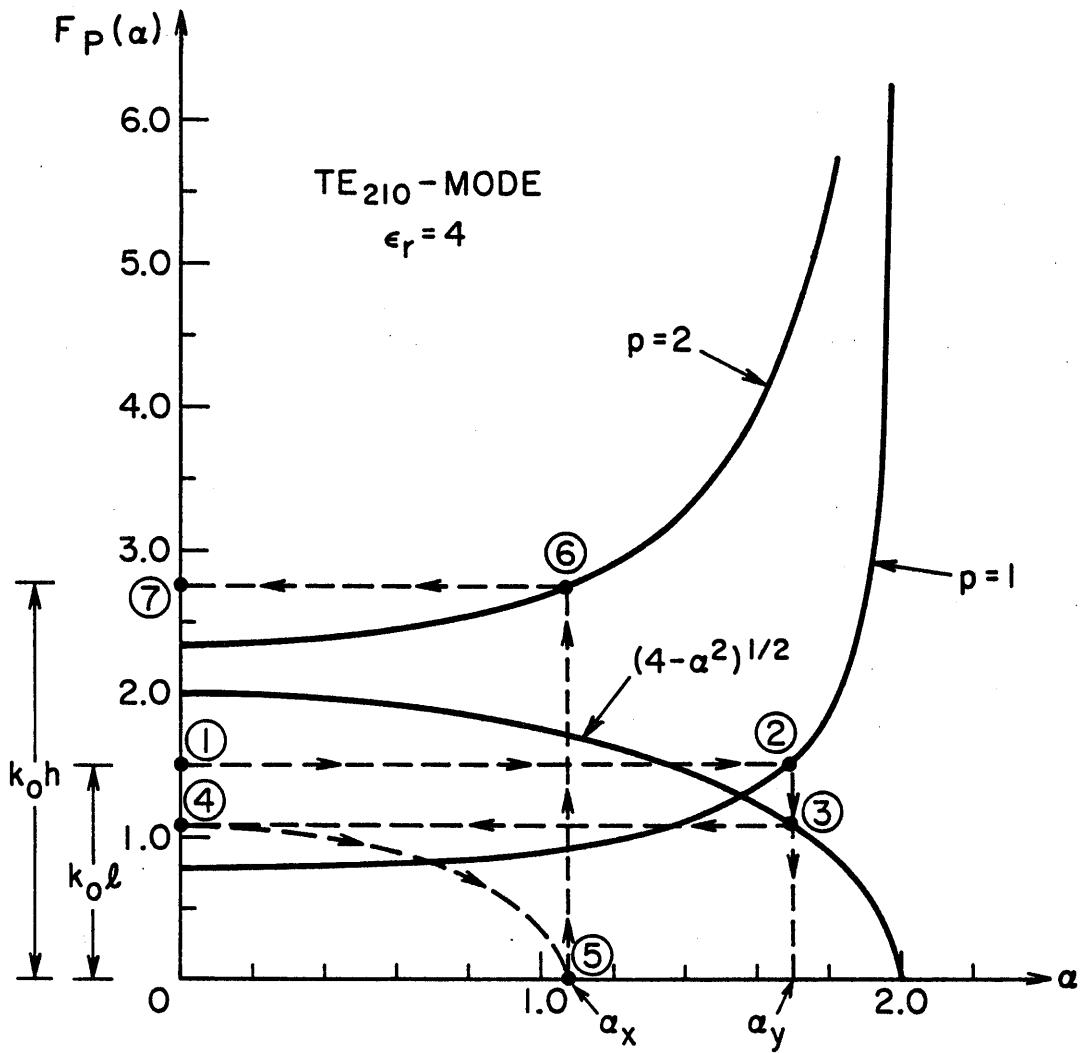

Fig. 2. Characteristic function  $F_p(\alpha)$  for a rectangular waveguide cavity,  $\epsilon_r = 4$ .

between the two walls  $y=0$  and  $2\ell$  at an angle  $\phi = \sin^{-1}(\alpha_y/n) \approx 58^\circ$  with respect to the  $y$ -axis, until it hits the wall at  $x=0$  or  $x=h$ . The angle of incidence at these two walls is  $32^\circ$ , which in turn yields an  $\alpha$  value of  $\alpha_x = (n^2 - \alpha_y^2)^{\frac{1}{2}} = 1.07$  as plotted in the same graph. For this value, we then determine from the  $p=2$  curve that  $\mathcal{F}_2(\alpha_x)$  and hence,  $k_0 h$  has to be 2.77 in order to achieve a transverse resonance in the  $x$ -direction. Consequently, the aspect ratio is given by  $h/\ell = 1.85$ . Computational procedure for yielding this result is labeled in sequence from (1) to (7) in Fig. 2, and indeed checks with the one obtained directly from (1).

At this point, one may ask what is to be gained from this seemingly more complicated procedure. Clearly, the graphical method can be easily generalized to the case when one or more waveguide walls are lined with a different impedance surface, since the expression for  $\chi(\alpha)$  is known explicitly. More important however, is the fact that the two angles of incidence (i.e.  $\alpha_x$  and  $\alpha_y$ ) for waves impinging onto the cavity walls are now built into the solution process. If, for instance, we know certain incidence angles have to be avoided in order to minimize absorption, we can simply block out the undesirable regions in the diagram in searching for the appropriate aspect ratios.

### 3. RECTANGULAR MICROSTRIP PATCH ANTENNA

As shown in Fig. 3, the structure of a microstrip patch is equivalent to that of a rectangular waveguide cavity, with all the four sides opened up and the dielectric slab together with the bottom plate extended out. Since the dimensions of the patch are typically larger than the slab thickness, the field is mainly confined to the region under the patch. This allows us to view the structure as an open resonator and to determine its resonant condition by considering the bouncing of the waves in the region under the patch. Following the discussion in the previous section, we can immediately conclude that the same computational procedure would apply, provided of course a new reflection coefficient  $\Gamma = |\Gamma| \exp(i\chi)$  is derived and used in conjunction with the characteristic equations (4) and (5). We must realize however, because the exterior region consists of a grounded dielectric slab capable of supporting surface-wave mode(s), appropriate physical mechanisms



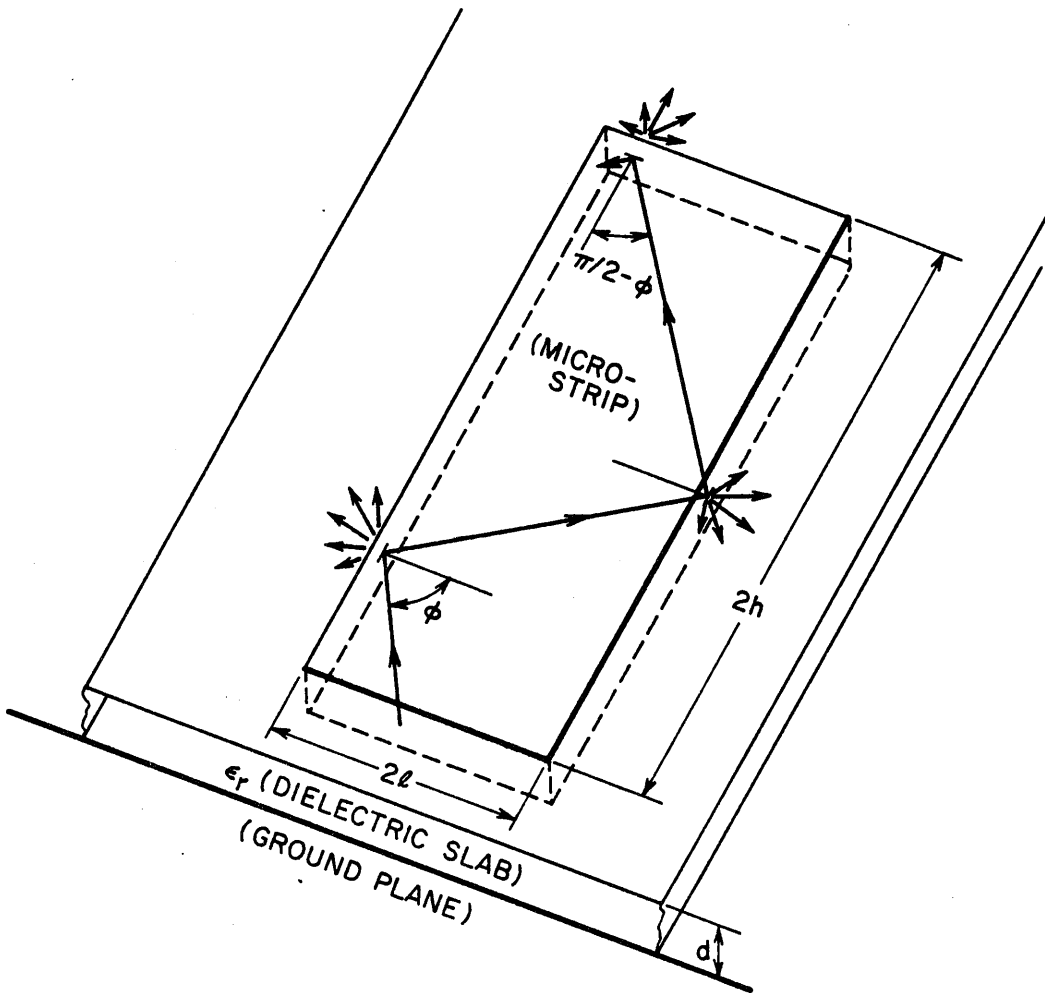

Fig. 1. Geometry of a rectangular waveguide cavity

must be built into the solution of  $\Gamma(\alpha)$ . Thus, before we proceed any further in discussing the resonant condition, we should investigate first the canonical problem of wave propagation in a semi-infinite, perfectly-conducting patch. For the discussion to be followed, we should assume a TEM wave of the same form as (2) is incident obliquely in the parallel-plate region between the patch and the ground plane at an angle  $\phi = \sin^{-1}(\alpha/n)$  with respect to the y-axis. This field is then partially reflected from the edge of the patch and partially radiated into the open region external to the patch. As we mentioned before, a grounded dielectric slab in the absence of the conducting patch can support a finite number of surface-waves, the exact number of which depends upon the so-called "numerical aperture" defined as  $V = (\mu_r \epsilon_r - 1)^{\frac{1}{2}} k_0 d$  of the structure. Among these, the LSE<sub>1</sub>-mode with the electric field polarized in the z-direction actually has no cut-off. This, in addition to the radiation field, one would at least expect the excitation of this wave as a direct result of the TEM-wave incidence. However, unlike a two-dimensional problem where one assumes no variation in the x-direction, both the surface-wave and the radiation field in the open region can propagate in one direction, while exponentially decay in another direction. For instance, since the total solution has to have the same variation of  $\exp(-ik_0 \alpha x)$  along the x-direction as the incident wave, the far-field observed at a fixed elevation angle  $\theta$  in any cross-section has to behave like  $f(\theta) \exp(ik_0 [1 - \alpha^2]^{\frac{1}{2}} r)$  in air where  $r$  is the radial distance from the parallel-strip waveguide opening. Depending upon the incident wave, the quality  $\alpha = n \sin \phi$  can vary from 0 to  $n$ . Therefore, for  $\alpha < 1$ , the "scattered" field indeed propagates radially away from the waveguide opening (Fig. 4a), but for  $1 < \alpha < n$ , the scattered field decays exponentially instead (Fig. 4b). In a very similar fashion, the field components associated with a surface-wave of wave number  $\alpha_p$  must behave like  $\exp[-k_0 (\alpha_p^2 - 1)z] \exp\{-ik_0 [\alpha x - (\alpha_p^2 - \alpha^2)^{\frac{1}{2}} y]\}$  in air. Thus, for  $\alpha_p < \alpha < n$ , an exponential decay of field in both y and z direction, is again observed. We note that the value of  $\alpha_p$  is determined from

$$\epsilon_r (\alpha_{p,e}^2 - 1)^{\frac{1}{2}} = (n^2 - \alpha_{p,e}^2)^{\frac{1}{2}} \tan[(n^2 - \alpha_{p,e}^2)^{\frac{1}{2}} k_0 d] \quad (6)$$

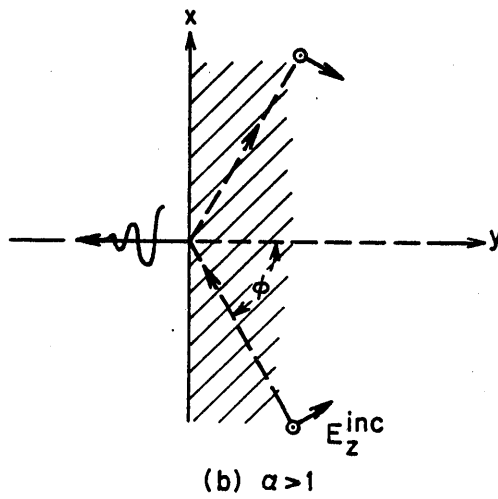
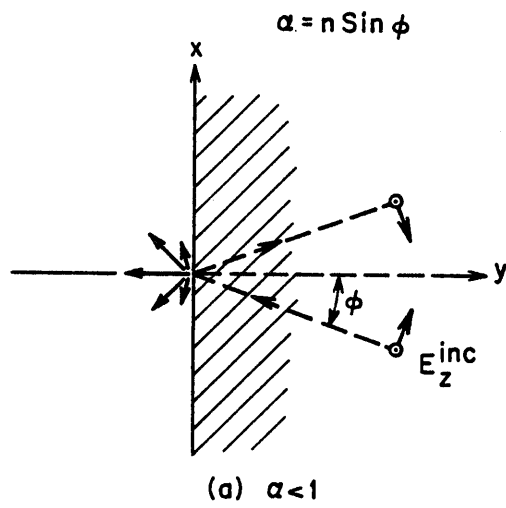

Fig. 4. Transmission and reflection of a TEM-wave obliquely incident onto the edge of a semi-infinite patch.

for LSE surface-waves, and from

$$\mu_r(\alpha_{p,m}^2 - 1)^{\frac{1}{2}} = (n^2 - \alpha_{p,m}^2)^{\frac{1}{2}} \cot[(n^2 - \alpha_{p,m}^2)^{\frac{1}{2}} k_0 d] \quad (7)$$

for LSM surface-waves (if they exist).

The above discussion points to a very important feature, unique to the study of oblique incidence. That is, whether the opening at the end, i.e.  $y=0$ , will actually allow the TEM-wave in the parallel plate region to radiate into the open-space or not depends upon the angle of the incident wave. A complete reflection of the wave is therefore entirely possible, if the angle of incidence  $\phi = \sin^{-1}(\alpha/n)$  is greater than some critical angle  $\phi_c = \sin^{-1}(\alpha_{p,\max}/n)$  where  $\alpha_{p,\max}$  is obtained from the surface-wave mode having the largest value of  $\alpha_p$ . Such a phenomenon is certainly not unlike a plane-wave incident obliquely from a lossless medium having a large refractive index to a medium with a smaller refractive index. Beyond critical angle, reflection coefficient has magnitude of unity.

Based upon these observations, an analytical theory involving the use of the Wiener Hopf technique as applied to two coupled integral equations for charge and longitudinal distributions on the patch, is developed in a companion paper. We found that the reflection coefficient is given as [5]

$$\begin{aligned} \Gamma(k_0; \alpha) &= |\Gamma| e^{i\chi} \\ &= \exp\{i[2 \tan^{-1}\left(\frac{\alpha}{[n^2 - \alpha^2]^{\frac{1}{2}}} \tanh \Delta\right) - \tan^{-1}\left(\frac{n^2 - \alpha^2}{\alpha^2 - 1}\right)^{\frac{1}{2}} + \psi]\} \end{aligned} \quad (8)$$

where the functions  $\Delta$  and  $\psi$  are two infinite integrals

$$\Delta(k_0; \alpha) = \frac{2}{\pi} \int_0^{\infty} \ln \left[ \frac{u_0 n^2}{u_n} \left( \frac{u_n + \mu u_0 \tanh u_n k_0 d}{n^2 u_0 + u_n \tanh u_n k_0 d} \right) \right] \frac{d\lambda}{\lambda^2 + \alpha^2} \quad (9)$$

$$\psi(k_0; \alpha) = \frac{2}{\pi} (n^2 - \alpha^2)^{\frac{1}{2}} \int_0^{\infty} \ln \left[ \frac{(1+n^2) u_0^2 \tanh u_n k_0 d}{u_n (n^2 u_0 + u_n \tanh u_n k_0 d)} \right] \frac{d\lambda}{\lambda^2 - (n^2 - \alpha^2)^{\frac{1}{2}}} \quad (10)$$

and  $u_o = (\lambda^2 + \alpha^2 - 1)^{\frac{1}{2}}$ ,  $u_n = (\lambda^2 + \alpha^2 - n^2)^{\frac{1}{2}}$  with the argument of  $u_o$  defined by  $\text{Re } u_o \geq 0$ . It is not difficult to show that in the complex  $\lambda$ -plane, the two integrands possess branch cuts of logarithmic nature at  $\lambda = \pm i(\alpha^2 - 1)^{\frac{1}{2}}$ , and at  $\lambda = \pm \lambda_e$  and  $\lambda_m$  where  $\lambda_{e,m} = i(\alpha^2 - \alpha_{pe}^2)^{\frac{1}{2}}$  and  $\alpha_{pe}$ ,  $\alpha_{pm}$  are the solutions of (6) and (7) representing the LSE and LSM surface wave modes. Now since the value of  $\alpha$  varies according to the incident angle of the TEM wave, location of these singularities and hence, the value of the two integrals can change accordingly. Assuming the thickness of the slab is such that only the LSE<sub>1</sub>-mode can propagate, we can consider three possible ranges of incident angle: (i)  $1 < \alpha_p < \alpha < n$ , (ii)  $1 < \alpha < \alpha_p < n$ ; (iii)  $\alpha < 1 < \alpha_p < n$ . In the first case,  $u_o$  is real and the integrand is not only real, but smoothly varying (except near  $\lambda = \sqrt{n^2 - \alpha^2}$ ) along the path of integration. Hence, the value of  $\Delta$ ,  $\psi$  and consequently,  $x(\alpha)$  are all real. The magnitude of  $\Gamma$  is therefore unity, and the incident power is completely reflected back. As we mentioned before, this situation is very similar to a plane-wave incident onto a dielectric interface beyond the critical angle. As in the case of a dielectric waveguide, the phenomenon certainly can be utilized to guide an electromagnetic wave along x-direction when the semi-infinite patch is truncated and a transverse resonance is imposed. On the other hand, for the case (ii) when  $1 < \alpha < \alpha_p$ , the branch point  $\lambda = \lambda_e$  will appear on the positive real axis. The integration from  $\lambda = 0$  to  $\lambda_e$  is now complex, as the logarithmic function in the integrands is real and negative. The magnitude of  $\Gamma$  is also less than unity, as part of the power is now used to excite the surface wave.

A similar situation also exists in case (iii) where  $\alpha < 1 < \alpha_p$ , because the logarithmic singularity associated with  $u_o$  also appears on the real axis. The magnitude of  $\Gamma$  would have to be even smaller, since power can now radiate into the open region in the form of "sky-waves."

From the form of  $\Gamma$ , one can also define the apparent end-admittance of such a structure as

$$Y_a(\alpha) = Y_o \frac{1-\Gamma}{1+\Gamma} = -iY_o \tan[x(\alpha)/2] \quad (11)$$

where  $Y_0 = (n_1 d)^{-1}$  ohm/m is the characteristic admittance of the TEM-wave in a parallel-plate waveguide. It suffices to note that this admittance is a function of both frequency and angle of incidence, and it is usually not valid to replace it by the value corresponding to the normal incidence.

To further investigate the property of  $\Gamma(k_0; \alpha)$  as a function of incident angle, we have included in Fig. 5 the plot of  $1 - |\Gamma|^2$  which represents the portion of power radiated into the open region in the form of both sky-waves and surface waves, and the phase of the reflected wave, i.e.  $\chi(k_0; \alpha)$  for a dielectric slab of relative permittivity  $\epsilon_r = n^2 = 10$  and thickness  $d = 1.27$  mm. The frequency of operation is chosen as 8 GHz. As expected, the amount of radiated power reduced to zero when  $\alpha > \alpha_p$  which for the present example, has a value of 1.02. The maximum amount of radiated power is about 16% and occurs when the wave is incident normally in the parallel-plate region between the patch and the ground plane. The phase of  $\Gamma(k_0; \alpha)$  on the other hand, increases monotonically from a negative value at  $\alpha = 0$ , to zero at  $\alpha = 2.16$ , and then to a positive value beyond  $\alpha = 2.16$ . The rate of increase is more rapid as  $\alpha$  increases, i.e., the incidence wave becomes more grazing.

For a microstrip of finite width, the information we obtained from Fig. 5 can now be used in determining the propagation constant of a guided mode along the microstrip structure. As we mentioned earlier, assuming the two edges of the strip can be reasonably separated, a wave can zig-zag along the strip with a propagation constant  $\alpha$  along the x-direction, provided a transverse resonance can be established. For the fundamental mode  $p = 0$ , the requirement is obtained from (3) as

$$k_0 \ell (n^2 - \alpha^2)^{\frac{1}{2}} = \chi(k_0; \alpha) .$$

Now since  $\chi(k_0; \alpha)$  in the present example is negative for  $\alpha < 2.16$ , the propagation constant of the fundamental mode,  $p = 0$ , has to be greater than 2.16 for any length of  $k_0 \ell$ . This is actually not surprising, as we know from the theory of a thin-wire, the value of  $\alpha$  should approach  $[(n^2 + 1)/2]^{\frac{1}{2}} \approx 2.35$  as  $k_0 \ell \rightarrow 0$  [6]. (Note that the present theory also breaks down

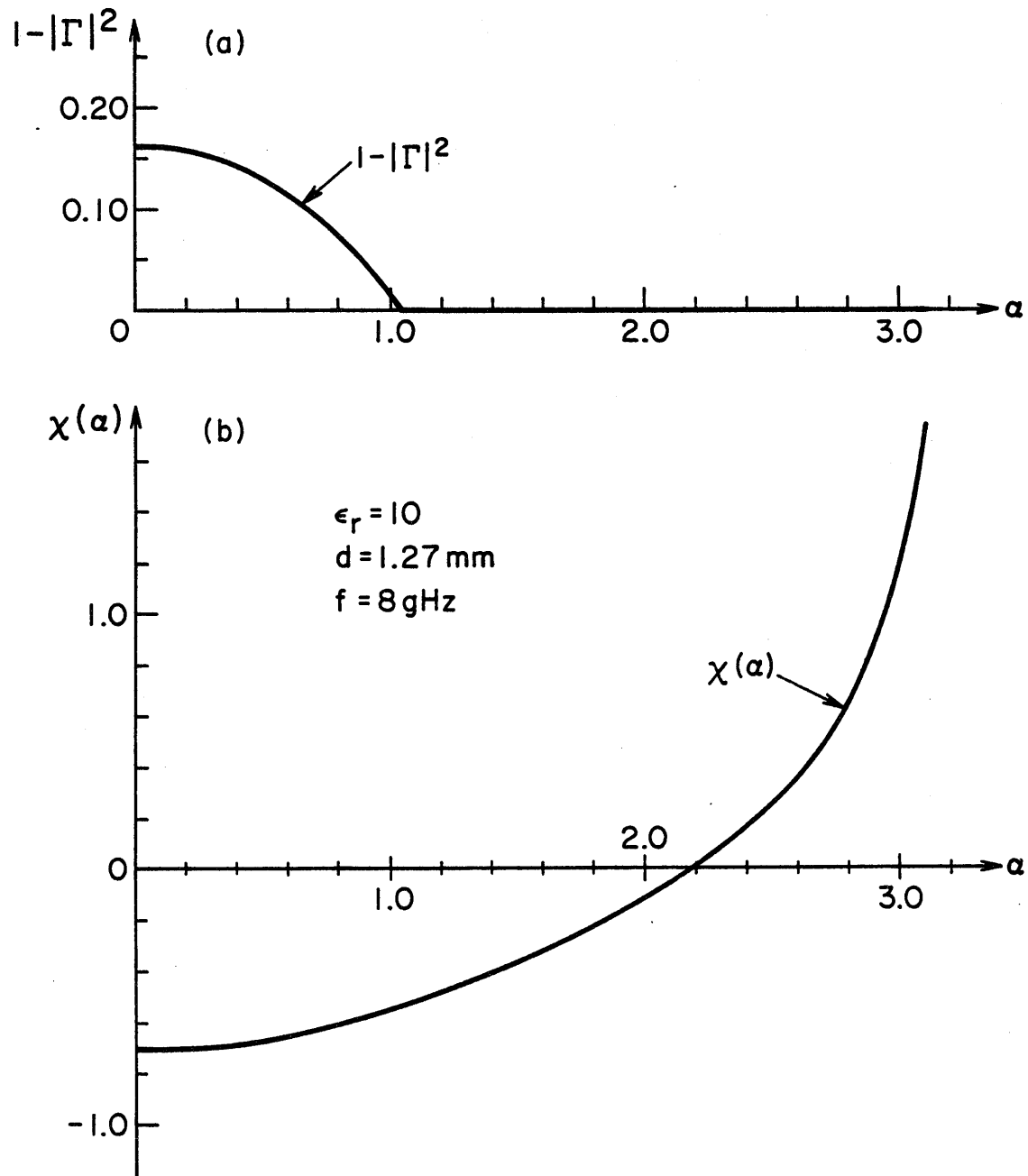

Fig. 5. Amplitude and phase of the reflected wave inside a semi infinite patch,  $\epsilon_r = 10$ ,  $d = 1.27 \text{ mm}$  and  $f = 8 \text{ GHz}$ .

when  $(k_0 \ell)^2 \ll 1$  because the two edges of such a strip can no longer be separated). More important however, is the fact that it is possible to propagate a  $p=0$  guided mode along the structure, even when the width of the strip is much smaller than a free-space wavelength. In this sense, the fundamental mode of a microstrip structure acts more like a parallel plate transmission line, rather than a rectangular waveguide which cannot support any  $p=0$  mode.

#### 4.0 RESONANT MICROSTRIP PATCH: DESIGN CONSIDERATION

We are now finally in the position to discuss some of the design considerations of a resonant microstrip patch. As in the case of a rectangular waveguide cavity, the aspect ratio of a patch for achieving a  $qp^{\text{th}}$  resonance at a given frequency can be obtained graphically from the characteristic equation

$$F_p(\alpha) = \frac{2p\pi + \chi(\alpha)}{2(n^2 - \alpha^2)^{\frac{1}{2}}} ; \quad p = 0, 1, 2, \dots \quad (4)$$

in the  $y$ -direction, and its counterpart,  $F_q(\sqrt{n^2 - \alpha^2})$  in the  $x$ -direction. In Fig. 6, the functions  $F_0$  and  $F_1$  are plotted against  $\alpha$ , for a dielectric slab of permittivity  $\epsilon_1 = 10 \epsilon_0$  and thickness  $d = 1.27$  mm operating at 8 GHz. We note that since the smallest possible  $\alpha$  for a guiding mode is  $[(n^2+1)/2]^{\frac{1}{2}}$  and since it is not possible to have both  $\alpha$  and  $(n^2 - \alpha^2)^{\frac{1}{2}}$  to be greater than this value, we can immediately discount the possibility of having a resonant mode where  $p=q=0$ . For  $p=1$  and  $q=0$  mode, the procedure is identical to the one we discussed earlier in conjunction with the  $TE_{210}$ -mode of a resonant waveguide cavity. Following the sequence of steps from (1) to (7) as demonstrated in Fig. 6, we conclude that for  $k_0 \ell = 2.26$ , the corresponding electric length in the  $x$ -direction has to be  $k_0 h = 1.8$ , or an aspect ratio of  $h/\ell \approx 0.8$ . Notice that the corresponding angle of incidence is respectively,  $\alpha_x = 0.6$  and  $\alpha_y = 3.1$ . In Fig. 7, the values of  $k_0 \ell$  vs. the corresponding values of  $k_0 h$  are shown for the fundamental mode ( $p=1, q=0$ ). We note that, even though  $k_0 \ell$  can vary over a very wide range, the corresponding range of  $k_0 h$  is much smaller and in any case cannot be less than 1.73.



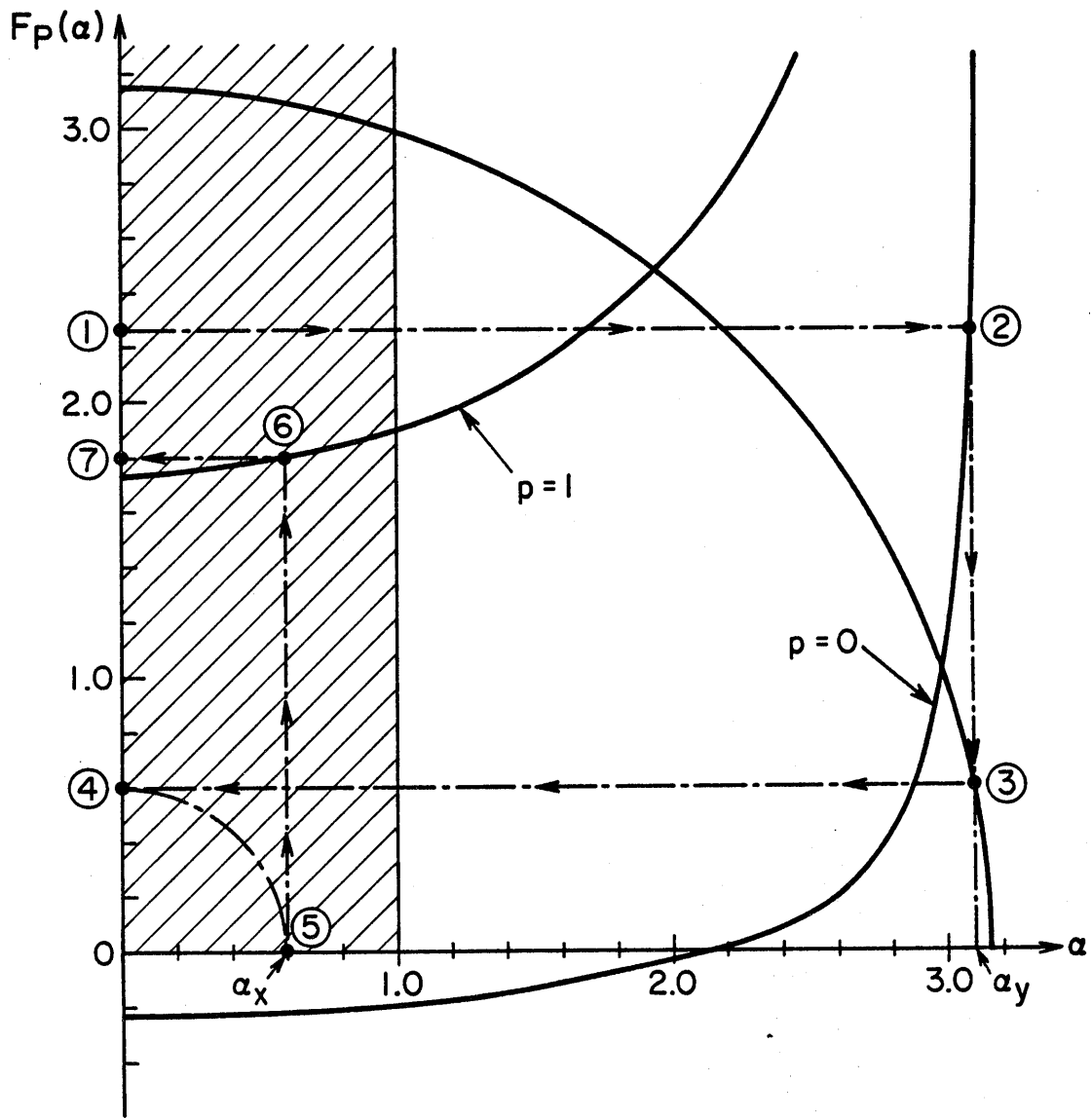

Fig. 6. Characteristic function  $F_p(\alpha)$  for a microstrip patch  $\epsilon_r = 10$ ,  $d = 1.27$  mm and  $f = 8$  GHz.

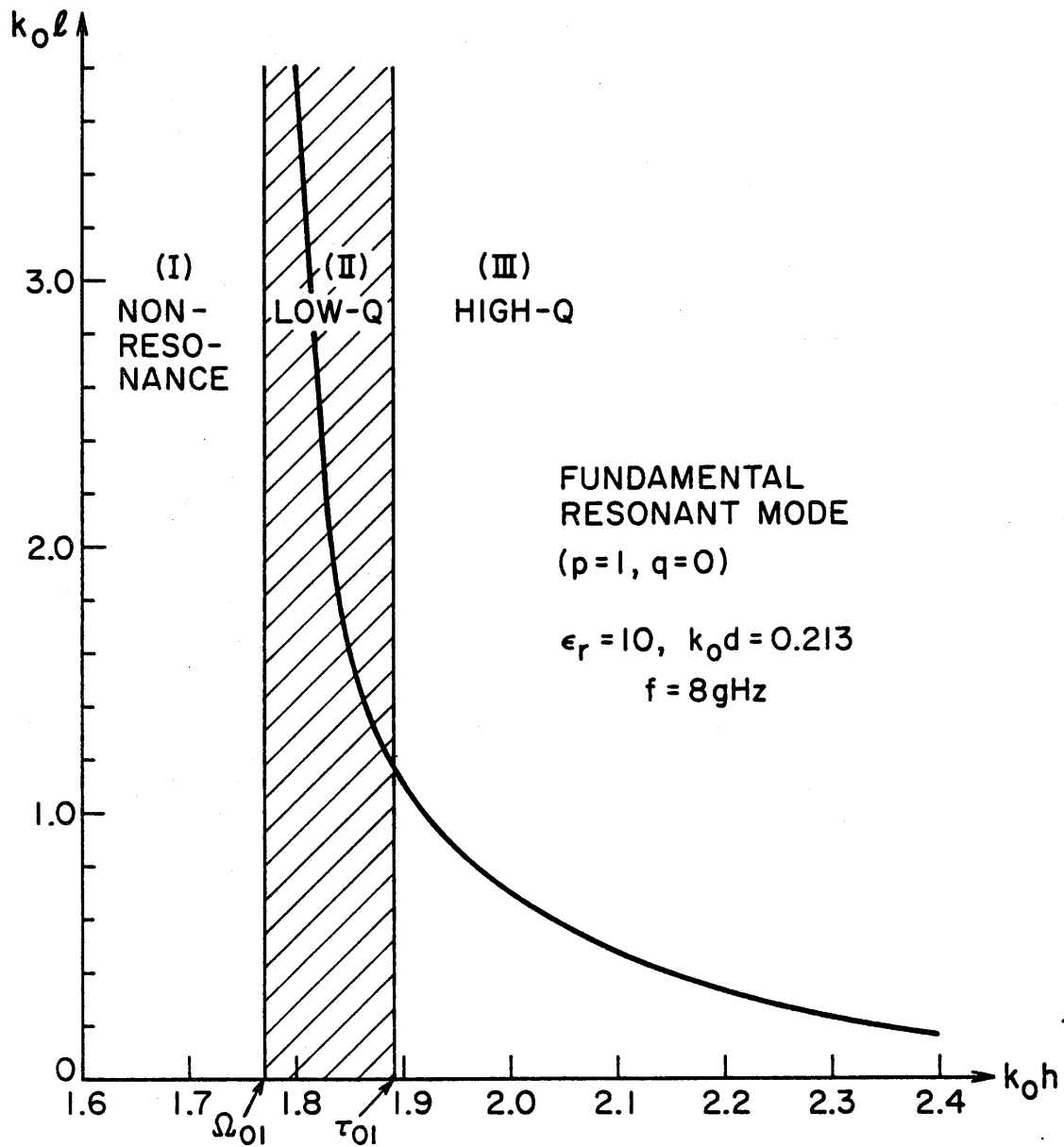

Fig. 7. Acceptable aspect ratio for the fundamental resonance of a rectangular microstrip patch antenna

We may now return to the question of whether we can enhance the radiation of a resonant microstrip path by adjusting its aspect ratio. Recalling from Fig. 5 that radiation of energy occurs only when  $\alpha$  is less than  $\alpha_p \approx 1.02$ , it is apparent in the present example that energy will be radiated from the two edges at  $x = 0$  and  $x = 2h$ , but not at the other two in the  $y$ -direction. Thus according to our earlier observation that more energy can be radiated by decreasing the angle of incidence, we would increase the width  $\ell$  at the same time, decrease the length  $h$ , although the degree of improvement becomes somewhat marginal as we keep continuing this process. On the other hand, if we decrease  $k_0 \ell$  instead of increasing it, we find from Fig. 6 that both the value of  $\alpha_x$  and  $\alpha_y$  become quickly greater than  $\alpha_p$ , and no radiation would occur within the stated limit of the present theory. The microstrip patch in this case acts more like a high Q resonator than a low Q antenna.

#### 5.0 REFERENCES

1. Munson, R.E., "Corner fed microstrip antennas and microstrip phase arrays," IEEE Trans. Ant. & Prop., 74-78, Jan. 1974.
2. Denneryd, A.G., "Linearly polarized microstrip antennas," IEEE Trans. Ant. & Prop., 846-851, Nov. 1976.
3. Carver, K.R., "A modal expansion theory for the microstrip antenna," Proc. Internat. Symp. Ant. & Prop., Seattle, Wash. 101-104, June 1979.
4. Harrington, R.F., Time Harmonic Electromagnetic Fields, Ch. 4, 155-157, McGraw Hill, New York, 1961.
5. Chang, D.C. and E.F. Kuester, "Total and partial reflection from the end of a parallel-plate waveguide with an extended dielectric loading," Scientific Rept. No. 50 Electromagnetics Laboratory, University of Colorado, Sept. 1979.
6. Coleman, B.L., "Propagation of electromagnetic disturbances along a thin-wire in a horizontally stratified medium," Phil. Mag. ser. 7, 41, 276-288, 1950.

ACKNOWLEDGMENT

The authors wish to thank Professor L. Lewin for many useful discussions and suggestions and to Mr. Robert Johnk who diligently read the manuscript and provided the numerical data. The work is supported by National Science Foundation under Grant No. 7809029.